



**Part # 11345010/11345110 (63-70) 11355010/11355110 (71-72) -GM C10 StreetGrip**

### Front Components

11339590	Delrin Control Arm Bushings
11349300/11359300	Drop Spindles
11332350/11332351	Front CoilSpring Kit
22139841	Front HQ Series Shocks
11339120	Front SwayBar

### Rear Components

11334799	Rear Dual Rate CoilSprings
11339099	Panhard Kit
11339699	C-Notch Kit
11339510	Rear HQ Series Shocks

### Recommended Tools

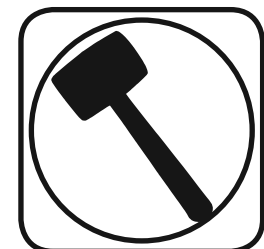

# 1963-1972 GM C10 Street Grip Installation Instructions

### Table of contents

Page 2.....	Major Components and Hardware List
Page 3.....	Getting Started
Page 4-7.....	Delrin Bushings
Page 8.....	Drop Spindles
Page 9-10.....	Front CoilSprings
Page 11.....	Front Shocks
Page 12-15.....	Front SwayBar
Page 16.....	Rear Dual Rate CoilSprings
Page 17-20.....	Rear C-Notches
Page 21-27.....	Panhard Bar Kit & Rear HQ Series Shock Kit

The majority of the StreetGrip components will be installed together. For example, the Front CoilSprings, Drop Spindles, Control Arm Bushings and Shocks will be installed in conjunction with each other. On the rear, the C-Notches, Panhard Kit, CoilSprings and Shocks will be installed in conjunction with each other. The front SwayBar will need to be installed **after** the rest of the front components are installed.

THIS KIT WILL NOT FIT TRUCKS WITH REAR LEAF SPRINGS.

www.ridetech.com  
812-482-2932





### Major Components .....In the box

Part #	Description	QTY
55104200/55104201	Front CoilSprings- Small Block/Big Block	2
55260356	Rear CoilSprings	2
90002589	Front CoilSpring Seats	2
11349300	Drop Spindles	1
90002604	Delrin Bushing Outer Shell - Upper Control Arm	4
90002608	Delrin Bushing Outer Shell - Lower Control Arm	4
70012658	Delrin Bushing - Upper Control Arm	4
70012661	Delrin Bushing - Lower Control Arm	4
90002605	Upper Bushing Inner Sleeve	4
90002609	Lower Bushing Inner Sleeve	4
90002603	Cross Shaft - Upper Control Arm	2
90002607	Cross Shaft - Lower Control Arm	2
	<b>Front &amp; Rear Shocks</b>	
22939999	3.850" Stroke Eye Top Shock - Front	2
22969999	5.75" Stroke Eyelet Top Shock - Rear	2
70011138	3/4" ID Shock Bushing (Installed in Shock) - Front & Rear	8
90002103	5/8" ID Shock Sleeve (Installed in Eyelet Front & Rear)	4
90002102	1/2" ID Shock Sleeve (Installed in Body Front & Rear)	4
90001617	Shock Stud	2
90002594	Rear Upper Shock Brackets	2
90002595/90002596	Rear Lower Shock Brackets - Driver & Passenger	2
11339120	Front Swaybar Kit	1
90002597	Driver C-Notch	1
90002598	Passenger C-Notch	1
90002599	Panhard Bar	1
90002600	Driver Axle Spacer Block	1
90002601	Passenger Axle Spacer Block w/Panhard Bar Mount	1
90001591	Heim End - Left Hand	1
90001589	Heim End - Right Hand	1
90002602	U-Bolt - 3/4"-16 - 3 1/2" x 10 1/2"	2
90000633	Heim End Spacers	4



## **Getting Started.....**

Congratulations on your purchase of the Ridetech StreetGrip Kit. This system has been designed to give your Truck excellent ride and handling along with a lifetime of enjoyment. Some of the key features of this Kit: Dual Rate Rear CoilSprings, Delrin Control Arm Bushings with new Cross Shafts, Larger Swaybar with Delrin Liners, Drop Spindles, Longer & Relocated Panhard Bar, and C-Notches.

The majority of the StreetGrip Components will be installed together. For example, the Front CoilSprings, Drop Spindles, Control Arm Bushings and Shocks will be installed in conjunction with each other. On the rear, the CoilSprings, Panhard Kit and Shocks will be installed in conjunction with each other. The Rear C-Notches can be installed at anytime during the rear component installation. The front SwayBar will need to be installed after the rest of the front components are installed.

## **Hardware Kit .....#99010066**

The StreetGrip Kit is supplied with a hardware kit. This hardware kit contains individual bags for the different kits within the main kit. The bags are labeled to help determine the correct hardware for the installation of the specific kits. The instructions will aid you in selecting the correct hardware for each component. The bags included in this kit are:

- Front Sway Bar Kit
- Control Arm Kit
- Panhard Bar Kit
- C-Notch Kit
- Front Shock Kit
- Rear Shock Kit

## **Front Suspension**

The front components that will need to be installed are: Control Arm Bushings, Drop Spindles, Shocks, and CoilSprings. The SwayBar needs to be installed after the rest of the front components are installed.

If you have never done this type of work before, we recommend getting a Factory Service Manual for proper procedures of disassembly and reassembly of the components for your truck.

## **Rear Suspension**

The rear components that will be installed are rear CoilSprings, C-Notches, Panhard Kit, and rear HQ Series Shocks. The Panhard Bar has been lengthened and relocated to minimize the rear differential movement.



**Part # 11339590 - 1963-1972 C10 Delrin Control Arm Bushings**



Recommended Tools

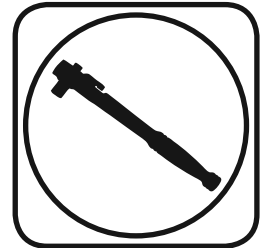

## 1963-1972 C10 Delrin Control Arm Bushings Installation Instructions

Table of contents

Page 5..... Included components and Hardware List

Page 6..... Bushing Installation



### Major Components .....In the box

Part #	Description	QTY
90002603	Upper Control Arm Cross Shaft	2
90002604	Upper Control Arm Bushing Outer Shell	4
90002605	Upper Bushing Inner Sleeve	4
70012658	Delrin Upper Control Arm Bushing	4
90002607	Lower Control Arm Cross Shaft	2
90002608	Lower Control Arm Bushing Outer Shell	4
90002609	Lower Bushing Inner Sleeve	4
70012661	Delrin Lower Control Arm Bushing	4

#### Hardware Bag - Control Arm Kit

Part #	Description	Usage	QTY
99622003	5/8" -18 Top Locknut	Upper Control Arm Shaft Nuts	4
99623001	5/8" SAE Flat Washer	Upper Control Arm Shaft Washers	4
99752005	3/4" -16 Top Locknut	Lower Control Arm Shaft Nuts	4
99753004	3/4" SAE Flat Washer	Lower Control Arm Shaft Washers	4

### Getting Started.....

The Front Control Arms will need to be removed from the truck. Mark the shims, they will be reinstalled in the same location they were removed from. Retain the OEM hardware for reassembly. Refer to the Factory Service Manual for disassembly procedure.

This C-10 Bushing Kit contains: 2 Upper Cross Shafts, 4 Upper Control Arm Bushing Assemblies, 2 Lower Cross Shafts and 4 Lower Control Arm Bushing Assemblies. The Upper Bushings are all the same and the Lower Bushings are the same. Be sure to match the correct Bushings with the correct locations.

The OEM Bushings are removed by threading them out of the Control Arm. It is easier to do with the cross shaft clamped in a vise.

1. Measure the Outside Width of the Control Arms and write it down before starting Bushing Removal. You will use this Dimension to check the Control Arms after the new Delrin Bushings are installed.



### Delrin Bushing Installation

The Cross Shaft must be put in place and in the correct orientation before installing the Bushing Shells in the Upper & Lower Control Arms.

Just like Bushing Removal, there are several ways the Delrin Bushing Assemblies can be installed. No matter the method used, the Control Arm needs to be **SUPPORTED** to keep from distorting the Control Arm. We recommend cutting spacers to go inside the Control Arms when using a Press to install the Bushings. We have used several different methods to install the Bushing Assemblies. We are going to cover the one that worked best for us. When installing the Bushings, the Outer Shell will be installed in the Arm by itself. Next, Press in the Delrin Bushing, followed by the Inner Sleeve. **WE DO NOT RECOMMEND INSTALLING THE BUSHINGS COMPLETELY ASSEMBLED.**

**DUE TO VARIATIONS IN THE THREADS OF THE CONTROL ARM, WE RECOMMEND TACK WELDING THE BUSHING SHELLS TO THE CONTROL ARM.**

**Note:** The Delrin is self-lubricating, no lubricant is needed.



**2. Disassemble the Bushing being installed. When installing Bushings in the Control Arms, insert the Cross Shaft before installing any Bushings.** Support the Back Side of the Flange the Bushing is being Installed in. Use a STIFF piece of Metal clamped in a Bench Vise for the Control Arms (**Figure 2**). They can be supported by either the piece of Metal or by the Bench Vise with the Jaws opened wide enough to let the Bushing Shell pass through (**Figure 3**).

**3. Use another Piece of Metal or Strong Wood to Drive the Outer Shell into the Control Arm until the Shell stops against the Control Arm.**



**4. Press the Delrin Bushing & Inner Sleeve into the Bushing Shell. DO NOT DRIVE IN WITH HAMMER. You may LIGHTLY tap them to get them started.**

**5. Reinstall the Outer Washer & Nylok Nut and finish pushing the Bushings in with the hardware. Tighten Hardware to eliminate any gaps between the Bushings and Cross Shaft.**

**6. Reattach Control Arms to Truck. Use the OEM Hardware & Shims to attach the Lower and Upper Control Arms.**



### Gusset Clearance

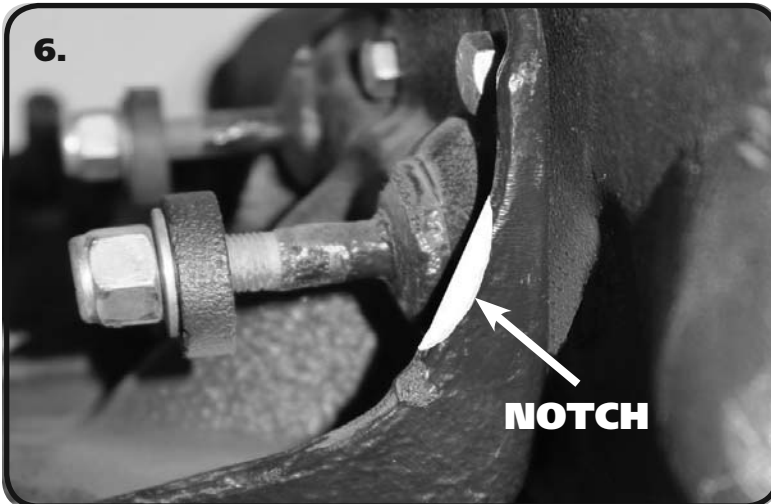

6. Due to variations in production, it may be necessary to notch the REAR gusset of the OEM Upper Control Arm Mount. After the Bushings are installed in the Upper Control arm, slide it on the Upper Control Arm Mounting Bolts to check for clearance. DO NOT have any Shims installed on the Mounting Bolts when checking for clearance. Slide the Control Arm on the Bolts until it is tight against the conical washers, check for clearance. Grind a notch in the Gusset to provide clearance if the Bushing is hitting.

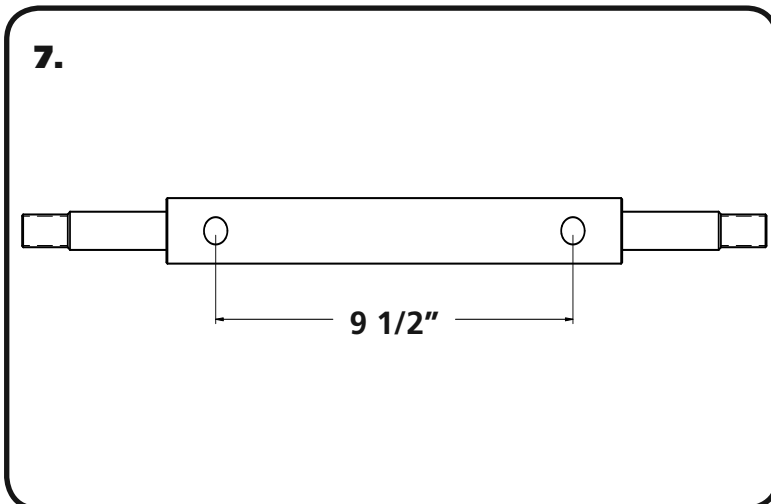

7. The Lower Cross Shaft has 2 different locating Hole patterns. This StreetGrip kit uses the 9 1/2" center to center locating holes. The Pin in the Cross Shaft Saddle will locate into these Holes.

8. Reattach Control Arms to Truck. Use the OEM Hardware to attach the Lower making sure the Locating Pin is in the 9 1/2" center to center Holes. Reattach the Upper Control arms using the OEM Hardware and reinstalling the Alignment Shims.



**Part # 11349300** (63-70) **11359300** (71-72) - C10 Drop Spindles



### Recommended Tools

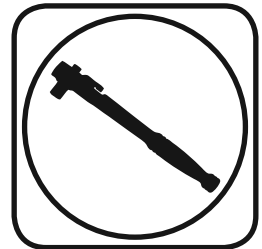

### Major Components .....In the box

1	11349301/11359301	Pair of 63-70/71-72 drop spindles
1	90001926	Pair of caliper brackets

## Installation

### Balljoint nut Torque Specs:

Upper: Torque to 50 ft lbs and then tighten nut to align cotter pin hole not exceeding 90ft lbs.

Lower: Torque to 90 ft lbs and then tighten nut to align cotter pin hole not exceeding 130 ft lbs.

**Note:** These spindles are set up for 1973-1987 HD Rotor and Caliper. The HD Rotor is 1 1/4" wide.



**Part # 11332350/11332351 - 1963-1972 C10 Front CoilSpring**



**Recommended Tools**

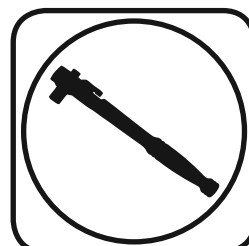

## 1963-1972 GM C10 Front CoilSprings Installation Instructions

Table of contents  
 Page 10..... CoilSpring Installation

### Major Components .....In the box

Part #	Description	QTY
55104200	Front CoilSprings	2
90002589	Front Coil Spring Seat	2
90002634	Big Block CoilSpring Spacer - <b>BIG BLOCK ONLY</b>	4

The Front Control Arm Bushings and Spindles should be installed before installing springs. The Front Suspension should be assembled with the Lower Balljoint disconnected from the Spindle.

The C10 StreetGrip CoilSpring utilizes an Upper Spring Seat setup. This Spring Seat setup allows the height of the truck to be adjusted by shimming the spring. Shims can be purchased through Ridetech or an authorized Ridetech Dealer.



### Getting Started.....



1. Remove the OEM Bumpstop from the lower control arm. Put a small pry bar under one end and pry it up, work your way to the other end prying it out as you go.

2. The Upper Coil Spring Seat is notched for a Rivet in the OEM Seat. The Notch **MUST** be lined up with the Rivet when installing the CoilSpring/Seat Combo.



3. The CoilSpring Seat is positioned on the top of the Coil Spring with the ring inserted into the CoilSpring. **Small Block requires NO Spacers. Big Block trucks require 2 Spacers on the Spring Seat.**

**BIG BLOCK ONLY - Install 2 Spacers on each CoilSpring Seat before setting it on the Spring.**

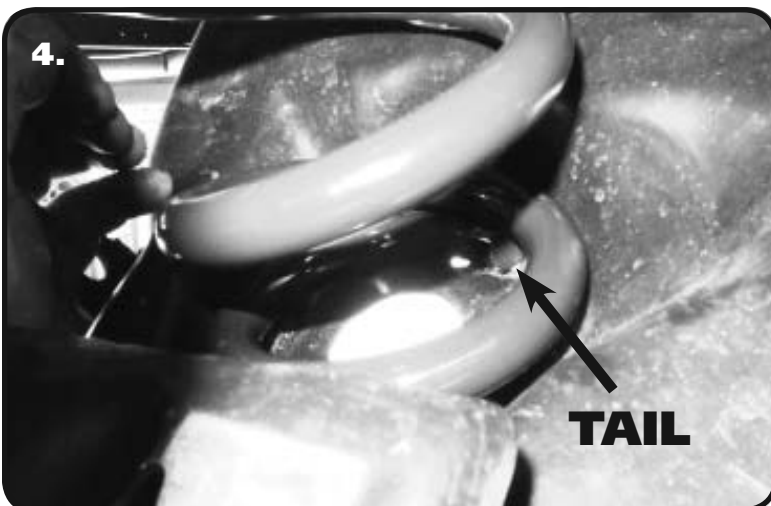

4. Insert the CoilSpring/Seat combo into the OEM coil spring pocket aligning the Rivet in the notch of the Upper Seat. Twist the spring on the Upper Seat to get the bottom of the CoilSpring lined up with the receiver in the control arm. The end of the CoilSpring needs to be nested into the receiver area of the Control Arm. Jack the control arm up to seat the CoilSpring and attached the bottom of the shock. With the Control Arm jacked up into position, install the bottom of the Spindle onto the Balljoint Pin. Torque the Balljoint nut to 90 ft lbs and then tighten nut to align cotter pin hole, not exceeding 130 ft lbs.



### 3.85" HQ Series Smooth Body Front Shocks

#### Major Components .....In the box

Part #	Description	QTY
22939999	3.85" Stroke Shock	2
70011138	3/4" ID Shock Bushing (Installed in Shock)	4
90002102	1/2" ID Shock Sleeve (Installed in Body)	2
90002103	5/8" ID Shock Sleeve (Installed in Eyelet)	2

#### Hardware Bag - Front Shock Kit

99501011	1/2"-20 X 2 1/2" Hex Bolt	2
99502003	1/2"-20 Thin Nylok Nut	2
99503001	1/2" Flat Washer	4

### Shock Installation

1.

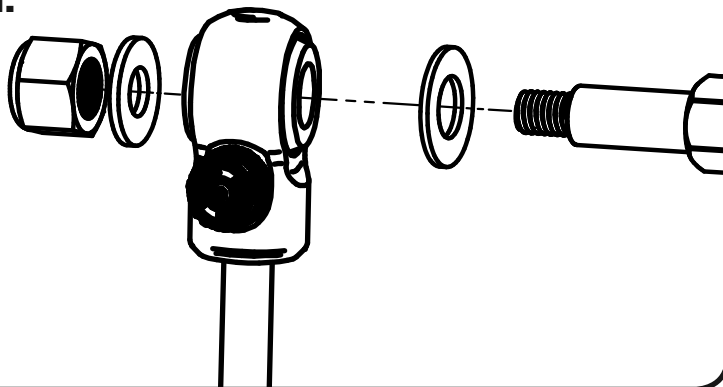

1. The Shock is supplied with 5/8" & 1/2" Sleeves. If the Sleeves are not installed, insert a 5/8" Sleeve in the shock eyelet bushing and the 1/2" Sleeve in the shock body bushing. They can be pressed in with a bench vise. Install the Eyelet of the shock on the OEM frame stud using the OEM hardware. Position the Shock with the Adjuster Knob pointing out, away from the frame.

2.

OEM SHOCK MOUNT

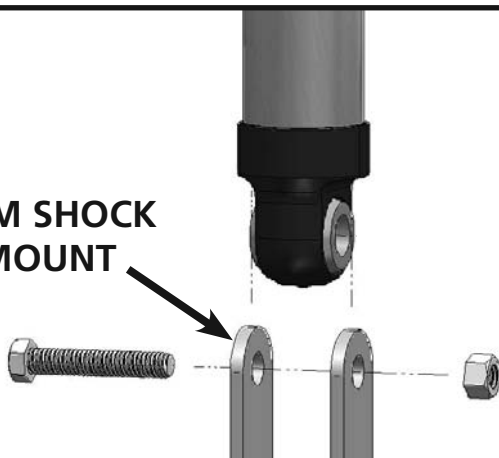

2. Attach the bottom of the Shock in the OEM location using the 1/2"-20 x 2 1/2" Bolt, Nut & Flat Washers supplied in the kit. The Lower Shock is Bolted to the Lower OEM Mount using the supplied Shock Sleeve.



### Part # 11339120 - 1963-1972 C10 Front SwayBar



#### Recommended Tools

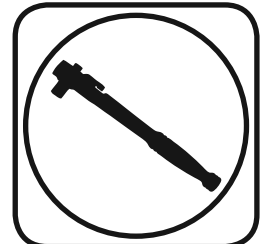

## 1963-1972 C-10 Front SwayBar Installation Instructions

Table of contents	
Page 13.....	Included Components and Hardware List
Page 14.....	SwayBar Installation
Page 15.....	SwayBar Installation

Install all Front StreetGrip Components before installing the SwayBar.

### Major Components .....In the box

Part #	Description	QTY
90002590	Front SwayBar	1
90002592	End Link Kit	1
70012401	Delrin Sway Bar Bushing Liner	2
90002513	Bushing Strap	2
90001099	SwayBar Bushing	2
90002591	SwayBar Mounting Bracket	2
90002593	Control Arm Mounting Tabs	2

#### Hardware Bag - Front Sway Bar Kit

99371004	3/8" -16 x 1 1/4" Hex Bolt	Frame & Control Arm Mount	12
99372002	3/8" -16 Nylok Nut	Frame & Control Arm Mount	12
99373003	3/8" SAE Flat Washer	Frame & Control Arm Mount	24



### Getting Started.....

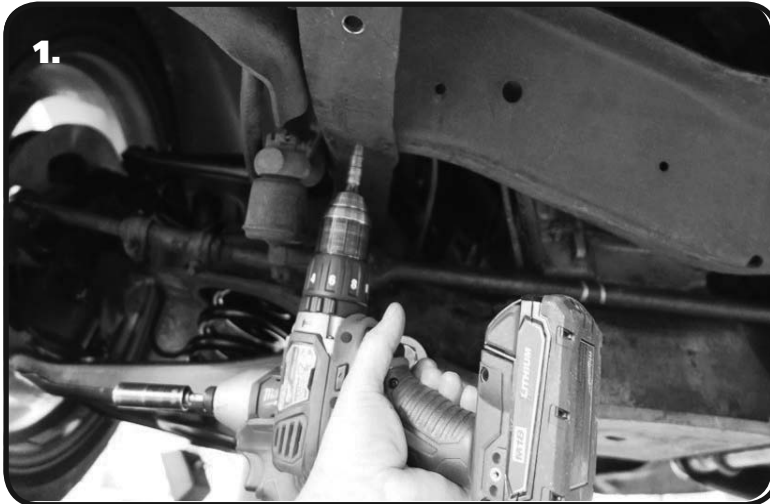

If your truck is equipped with an OEM Swaybar, remove it to prepare for the StreetGrip SwayBar installation.

**1.** Remove the rivet from the bottom of the frame rail. This can be done by cutting the rivet head off and driving it out or by drilling it out. This cross member is located in front of the suspension cross member.



**1.** Attach the rear hole of the Frame Mounting Bracket to the frame using the rivet hole. The end of the frame bracket with the angled bends goes forward. Attach the bracket using a 3/8"-16 x 1 1/4" bolt, 3/8"-16 Nylok nut and a 3/8" Flat Washer on top and bottom. With the rear hardware installed, line up the bracket parallel with the frame rail. Use the front hole as a guide to drill a 3/8" hole in the frame. Attach the front of the bracket using a 3/8"-16 x 1 1/4" bolt, 3/8"-16 Nylok nut and a 3/8" Flat Washer on top and bottom. Repeat on the other side and tighten hardware.



**3.** The Delrin Liner is split on one side to ease installation. We found it easier to install by opening up the Liner enough to slide it onto the end of the SwayBar, then sliding it into position. It will open up and slide over the curves in the Bar. Install a Liner on each side of the SwayBar in the approximate location they will need to be when installing the SwayBar on the Truck.

**Note:** The Delrin is self-lubricating, no lubricant is needed.



### SwayBar Installation



4. Open up the Poly SwayBar Bushings and install them over the Delrin Sleeves.

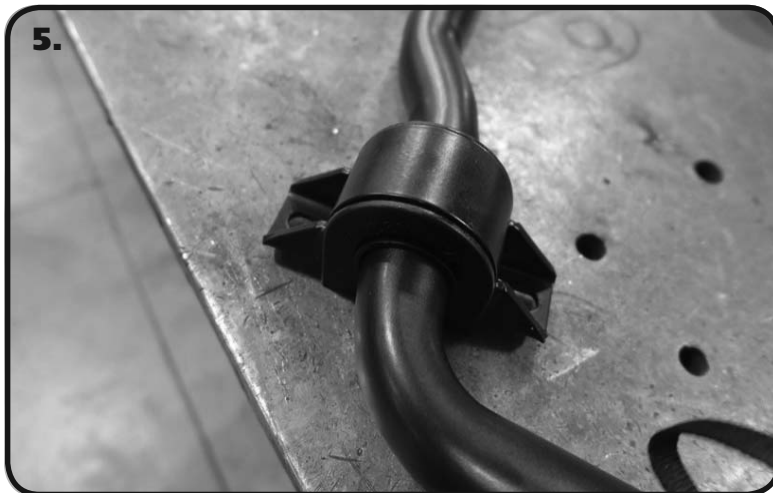

5. Install Bushing Straps Over the Poly Sway-Bar Bushings.



6. Hold the SwayBar into position on the truck with the SwayBar arms below the tie rods. Align the holes in the Bushing Straps with the holes in the Frame Brackets. Install a 3/8" Flat Washer on (4) 3/8"-16 x 1 1/4" Hex Bolts and insert them into the holes. Install a 3/8" Flat Washer and 3/8"-16 Nylok Nut on each Bolt. Center the bar in the bushings before snug-ging up the hardware. Do **NOT** completely tighten the Hardware. It will be left partially loose until the End Links are installed.



### SwayBar Installation

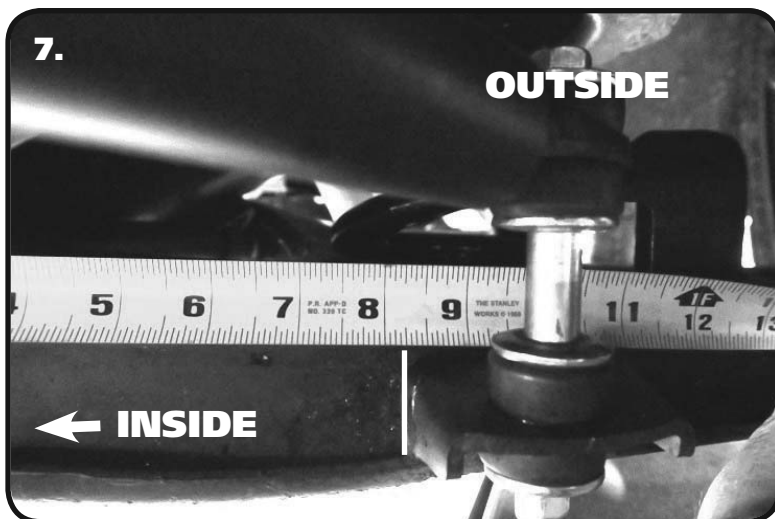

7. This kit requires a Bracket to be installed on the control arm for the sway bar linkage. The Bracket needs to be positioned with the inside edge 8 1/4" from the CONTROL ARM BUSHING and the ears pointing DOWN. Hold the end of the tape measure against the outer edge of the Control Arm Bushing and make a mark on the Control Arm at 8 1/4". Hold the Bracket on the Control Arm with the ears pointing DOWN and against the lip of the control arm. Use the bracket to mark and drill the mounting holes to 3/8".

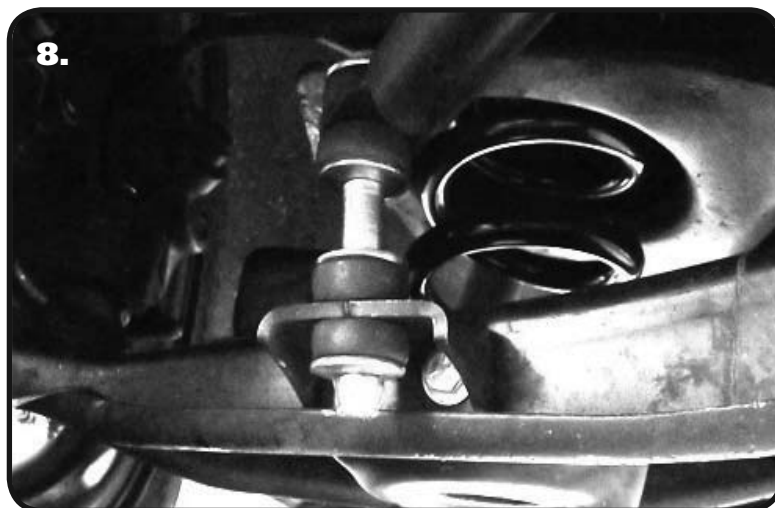

8. Install a 3/8" Flat Washer on (2) 3/8"-16 x 1 1/4" Hex Bolts and insert them into the holes. Install a 3/8" Flat Washer and 3/8"-16 Nylok Nut on each Bolt. Repeat on the other side and tighten hardware.

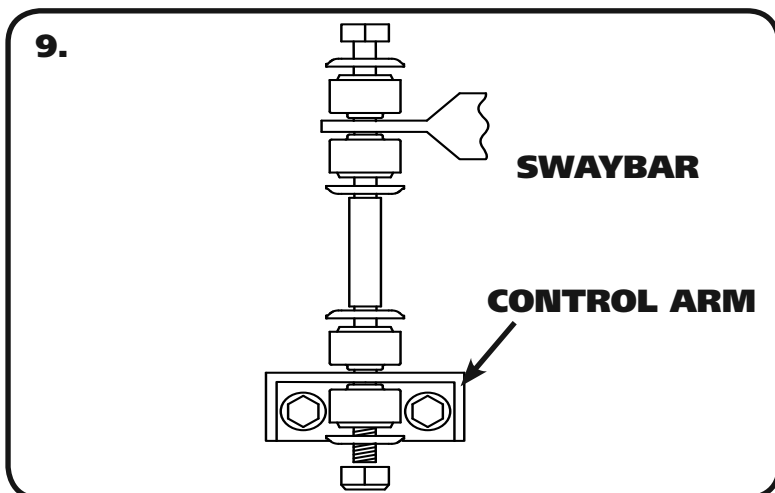

9. Install the End Links. Use Diagram "6" for proper installation. Tighten the Hex Nut enough to slightly compress the Bushings.

10. Tighten the Sway Bar Mounting Hardware.



### Part # 11334799 - 1963-1972 C10 Rear CoilSpring



#### Recommended Tools

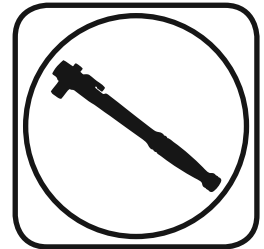

## 1963-1972 C10 Rear Dual Rate CoilSprings

# Installation Instructions

### CoilSpring # 55260356 Installation

Rear dual-rate springs allow the vehicle to transition small road irregularities via a soft spring rate. When the vehicle compresses the spring far enough (through large bumps or cornering), it transitions to the firmer spring rate to control the bump or body roll. We have worked closely with Hyperco to develop custom dual rates to ensure the best ride possible.

**The Rear Shocks & Panhard Kit should be installed at the same time as the Rear CoilSprings.**

1. Refer to the Factory Service Manual for CoilSpring Removal.
2. Position the Spring in the OEM location with the CLOSE coils to the bottom. Attach the top of the spring to the frame rail with the OEM hardware.
3. With the top of the spring attached, slowly Jack the Differential up until the bottom Spring can be attached to the trailing arm using the OEM Hardware.



### Part # 11339699 - 1963-1972 C10 Rear C-Notch



#### Recommended Tools



## 1963-1972 C-10 Rear C-Notch Installation Instructions

#### Table of contents

Page 18.....	Included components
Page 19.....	"C" Notch Installation
Page 20.....	"C" Notch Installation



### Major Components .....In the box

Part #	Description	QTY
90002597	Driver C-Notch	1
90002598	Passenger C-Notch	1

#### Hardware Bag - C-Notch Kit

Part #	Description	Usage	QTY
99431002	7/16"-14 x 1 1/4" Hex Bolt	C-Notch to Frame	10
99432001	7/16"-14 Nylok Nut	C-Notch to Frame	10
99433002	7/16" Flat Washer	C-Notch to Frame	20
99371004	3/8"-16 x 1 1/4" Hex Bolt	C-Notch to Frame	8
99372002	3/8"-16 Nylok Nut	C-Notch to Frame	8
99373003	3/8" Flat Washer	C-Notch to Frame	16

### Getting Started.....

**THIS C-NOTCH CAN BE INSTALLED WITH OUT REMOVING THE BED.**

**USE CAUTION WHEN CUTTING AND DRILLING THE FRAME RAIL. CHECK FOR BRAKE LINES, FUEL LINES AND WIRING BEFORE DOING ANY CUTTING OR DRILLING.**

**DEPENDING ON HOW THE LINES AND WIRING ARE INSTALLED ON THE TRUCK, THEY MAY NEED TO BE RELOCATED OR MODIFIED.**

A template is supplied with the kit to aid in cutting and drilling the frame.



**1.** The Rivet needs to be removed from the rear of the OEM coilspring mount. One way is to cut a "+" in the head of the rivet and chisel the 4 pieces of the head off the rivet, then knock the rivet out of the frame with a hammer and punch. It can also be drilled out.



### C-Notch Installation



2. Remove the OEM bumpstop mounts from the frame rails by removing the rivets. Again, one way is to cut a "+" in the head of the rivet and chisel the 4 pieces of the head off the rivet, then knock the rivet out of the frame with a hammer and punch. It can also be drilled out.

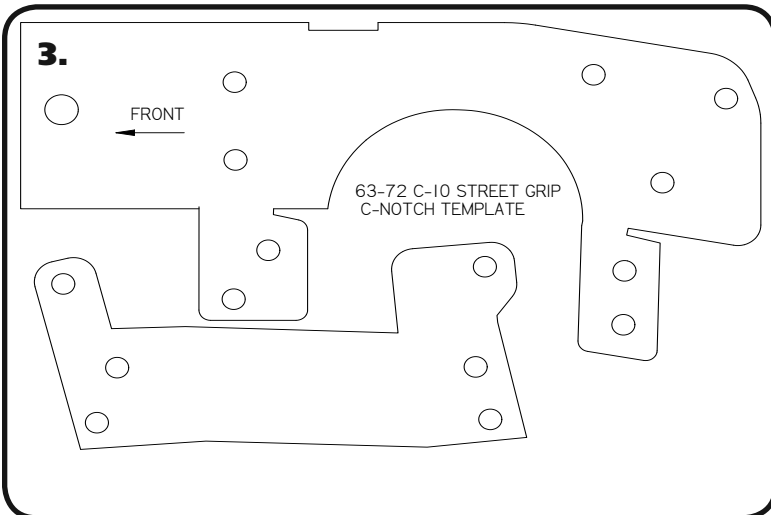

3. Use the supplied C-Notch template to mark the area to be cut and the holes to be drilled. We suggest doing one side at a time. The C-Notch template has an arrow pointing to the front of the truck. Use the 5/8" hole to locate the template on the frame. Wrap the bottom tabs around the bottom of the frame. The 2nd Template is provided to aid with the alignment of the bottom holes. The Rivet hole should line up with the front tab. Drill the side holes with a 7/16" drill bit. Drill the bottom holes with a 3/8" drill bit.



4. Diagram "3" shows the frame rail marked before cutting. The bottom of the frame will also need marked for cutting.



### C-Notch Installation



5. Diagram "4" shows the side and bottom of the frame after it has been cut.

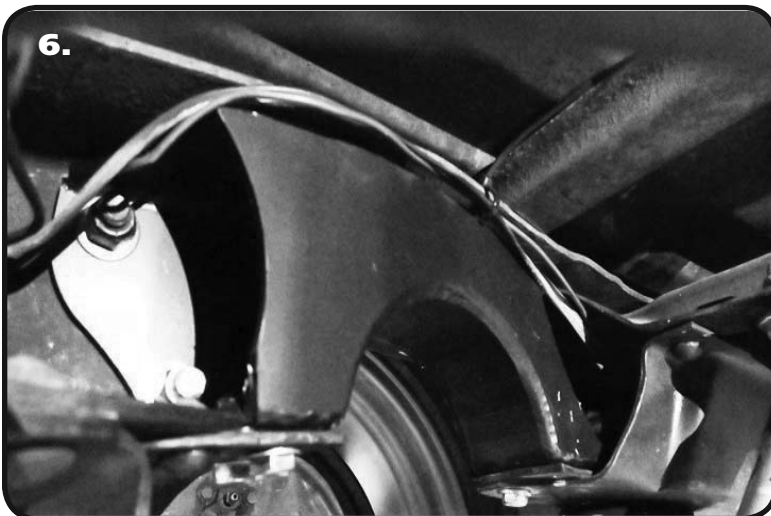

6. Slide the C-Notch into the frame rail.



7. Install a 7/16" Flat Washer on (5) 7/16"-14 x 1 1/4" Hex Bolts. Insert them through the holes in the frame side. Install a 7/16" Flat Washer and 7/16"-14 Nylok. Install a 3/8" Flat Washer on (4) 3/8"-16 x 1 1/4" Hex Bolts, insert them in the bottom holes and install a 3/8" Flat Washer and 3/8"-16 Nylok Nut on the threads sticking through. Tighten all hardware and repeat on other side.



### Part # 11339510 & 11339099 - 63-72 C10 Rear Shock & Panhard Kit



#### Recommended Tools



## HQ Series Rear Shock Kit & Panhard Kit Installation Instructions

### Table of contents

Page 22.....	Components
Page 23.....	Shock Mount Installation
Page 24.....	Spacer Block Installation
Page 25.....	Lower Shock Mount & Panhard Bar Installation
Page 26.....	Shock Installation
Page 27.....	Finishing & Shock Adjustment



### HQ Series Smooth Body Shocks & Panhard Kit

#### Major Components .....In the box

#### SHOCK COMPONENTS

Part #	Description	QTY
22969999	5.75" Stroke Shock	2
70011138	3/4" ID Shock Bushing (Installed in Shock)	4
90002103	5/8" ID Shock Sleeve (Installed in Shock Eyelet)	2
90002102	1/2" ID Shock Sleeve (Installed in Shock Body)	2
90002594	Upper Shock Mount Brackets	2
90002595	Lower Shock Mount Bracket - Driver	1
90002596	Lower Shock Mount Bracket - Passenger	1
90001617	5/8" Shock Stud Kit	2

#### Hardware Bag - Rear Shock Kit

99431002	7/16"-14 x 1 1/4" Hex Bolt	Upper Shock Mount to Frame	4
99433002	7/16" Flat Washer	Upper Shock Mount to Frame	8
99432001	7/16"-14 Nylok Nut	Upper Shock Mount to Frame	4
99501003	1/2"-20 x 2 3/4" Hex Bolt	Shock to Upper Shock Mount	2
99503001	1/2" Flat Washer	Shock to Upper Shock Mount	4
99502008	1/2"-20 Nylok Nut	Shock to Upper Shock Mount	2

#### PANHARD KIT COMPONENTS

Part #	Description	QTY
90002599	Panhard Bar	1
90002600	Axle Spacer - Driver	1
90002601	Axle Spacer - Passenger	1
90000633	Heim Spacers	4
90001591	Heim End - Left Hand	1
90001589	Heim End - Right Hand	1
90002602	U - Bolt - 3/4"-16	2

#### Hardware Bag - Panhard Bar Kit

99752006	3/4"-16 Jam Nut - LH	Heim for Panhard	1
99752004	3/4"-16 Jam Nut - RH	Heim for Panhard	1
99621005	5/8"-18 x 3 1/2" Hex Bolt GR8	Panhard Bar to Mounts	2
99622001	5/8"-18 Nylok Nut GR8	Panhard Bar to Mounts	2
99623001	5/8" Flat Washer	Panhard Bar to Mounts	4
99752001	3/4"-16 Nylok Nut	U-Bolts	4
99753004	3/4" Flat Washer	U-Bolts	4



### Shock Mount Installation



1. Remove the OEM shocks and panhard bar from the Truck.
2. The rivets holding the OEM upper shock mount will need to be removed. One way is to cut a "+" in the head of the rivet and chisel the 4 pieces of the head off the rivet, then knock the rivet out of the frame with a hammer and punch. They can also be drilled out.



3. Drill the 4 rivet holes out to 7/16".

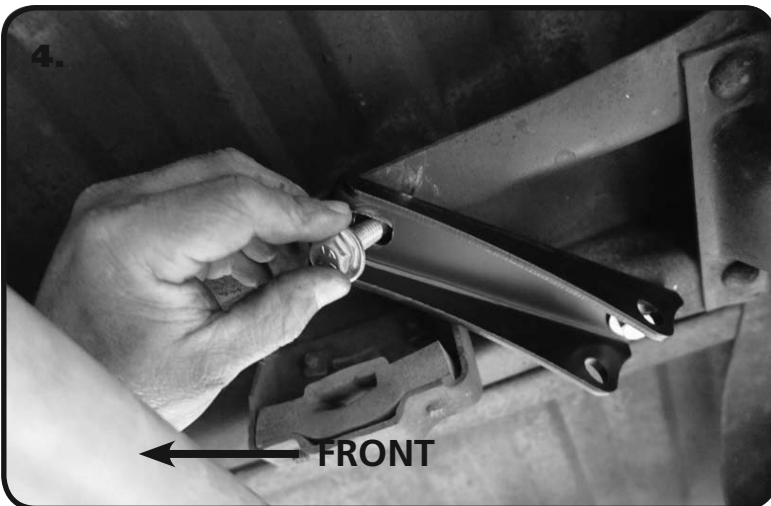

4. Install a 7/16" Flat Washer on each 7/16"-14 x 1 1/4" Bolts. Position the Shock Bracket in the same location as the OEM shock mount with the shock mounting holes to the rear of the truck. Line up the front and rear holes and insert the 7/16" Bolt/Washer from the bottom with the threads pointing up. Install a 7/16" Flat Washer and 7/16"-14 Nylok on the threads of the bolt. Repeat steps 3-5 on both shock mounts. Tighten Hardware.



### Spacer Block Installation



5. Remove the OEM lower shock mount by removing the u-bolt nuts. Remove the U-Bolts.



6. The kit contains 2 spacer blocks with one having the panhard mount welded to it. The spacers are installed between the axle and the trailing arm. The spacer block with the mount welded to it is installed on the passenger side with the mount positioned to the rear inside. Remove the OEM u-bolt and install the u-bolt supplied in the kit. Slide the spacer block onto the u-bolt followed by the OEM trailing arm.



7. Diagram "5" shows the passenger spacer block installed. Note the position of the panhard mounting tabs.

Repeat this process for both spacer blocks.



### Lower Shock Mount & Panhard Bar Installation

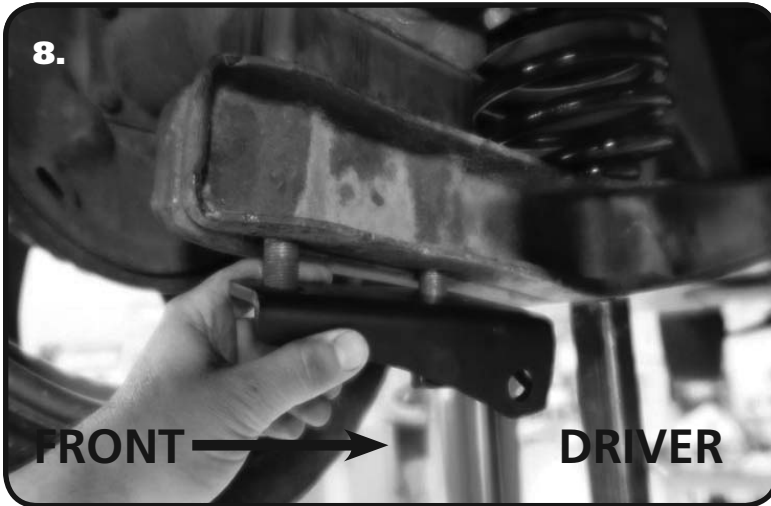

**8.** Next, install the Lower Shock Brackets. The brackets are installed on the U-Bolts, on the bottom side of the trailing arm. The shock mounting hole should be positioned with the hole to the front and to the inside of the truck. Once the Mount is installed, install a 3/4" Flat Washer and 3/4"-16 Nylok Nut on each leg of the U-Bolts. Tighten the Nylok Nuts to 350ftlbs.

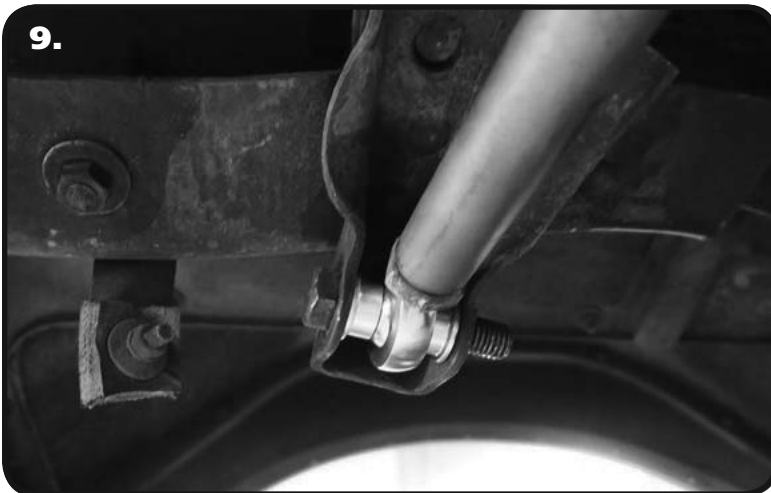

**9.** Install the panhard bar in the frame mount. It is installed with a Spacer on each side of the Heim. The Spacer is positioned with the small diameter against the heim. The large diameter of the Spacers should be against the mounting tabs. Install a 5/8" Flat Washer on a 5/8"-18 x 3 1/2" Hex Bolt and insert it through the Mount, Spacers and Panhard bar. With the Bolt installed, install a 5/8" Flat Washer on the threads followed by a 5/8"-18 Nylok Nut.



**10.** Repeat the procedure in step 9 on the axle side of the Panhard Bar. You may need to push the rear differential to one side or the other to get the Panhard bar lined up in the Mount.



### Shock Installation



11. Install the supplied Shock stud in the Lower Shock Mount. The stud should be installed with the STUD pointing to the center of the truck. Install a 5/8" Washer (supplied with stud kit) on the 5/8"-18 Thread side of the Stud and insert it into the Shock Bracket. Install a 5/8" Washer and Nylok Nut on the threads and tighten. Do this for both shock brackets, installing the Studs with the small threads pointing to the center of the truck.



12. The Shock is mounted in the Upper Mount with the BODY UP. It is held in place with a 1/2"-20 x 2 3/4" Hex Bolt & 1/2"-20 Nylok with a 1/2" Flat Washer on each side of the bracket.

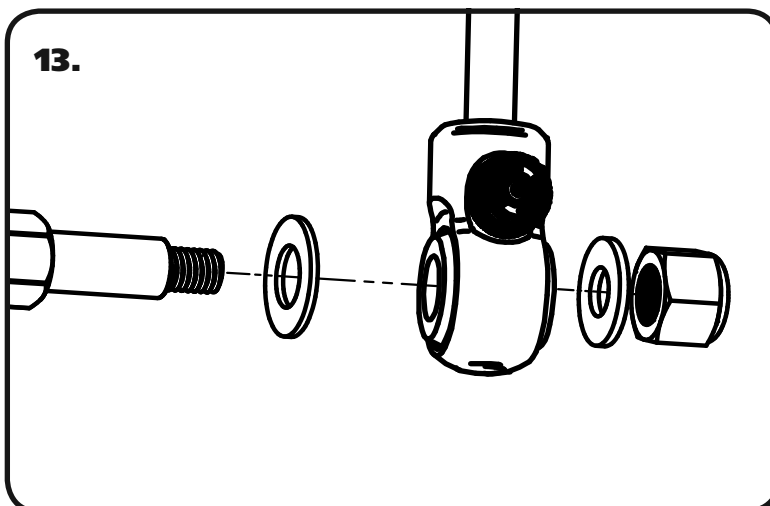

10. The Eyelet end of the Shock needs to be installed on the Stud. First, install a 5/8" Washer on the Stud. Next, slide the Shock Eyelet on the Shock Stud. You will have to jack the rear differential up to get the shock installed on the stud. Once the Shock is on the Stud, install a 7/16" washer and 7/16"-20 Nylok Nut. Repeat on other side and tighten hardware.



### Finishing

#### 14. Tighten the Hardware

**15.** The Panhard is designed to keep the rear differential centered at ride height. After the remainder of the StreetGrip is installed, measure the axle center position. It is best to measure it from the frame to the axle, but make sure you are measuring in the same spot on both sides. To adjust it, loosen the Jam Nuts at each Heim and turn the bar to center the rear differential. Once it is centered, tighten the Jam Nuts on each Heim making sure the Heims are lined up with each other.

### Shock adjustment 101- Single Adjustable

#### Rebound Adjustment:

How to adjust your new shocks

The rebound adjustment knob is located on the top of the shock absorber protruding from the eyelet or stud top. You must first begin at the ZERO setting, then set the shock to a street setting of 12 or handling setting of 8.

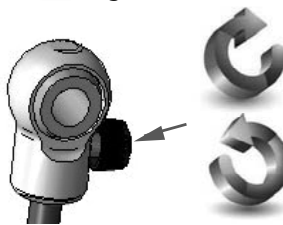

-Begin with the shocks adjusted to the ZERO rebound position (full stiff). Do this by rotating the rebound adjuster knob clockwise until it stops.

-Now turn the rebound adjuster knob counter clockwise 12 clicks. This sets the shock at 12 for a street setting. If you are after a handling setting only go 8 clicks.

#### Take the vehicle for a test drive.

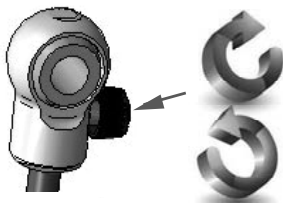

-if you are satisfied with the ride quality, do not do anything, you are set!

-if the vehicle is too soft increase the damping effect by rotating the rebound knob clockwise 3 additional clicks.

-If the vehicle is too stiff rotate the rebound adjustment knob counter clock wise 2 clicks and you are set!

Take the vehicle for another test drive and repeat the above steps until the ride quality is satisfactory.

#### Note:

**One end of the vehicle will likely reach the desired setting before the other end. If this happens stop adjusting the satisfied end and keep adjusting the unsatisfied end until the overall ride quality is satisfactory.**