

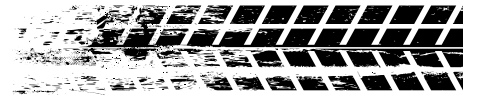

**INSTALLATION
INSTRUCTIONS**



Part # 12129511



Rear S550 Caliper Brackets

1979-1993 Mustang w/Ridetech IRS

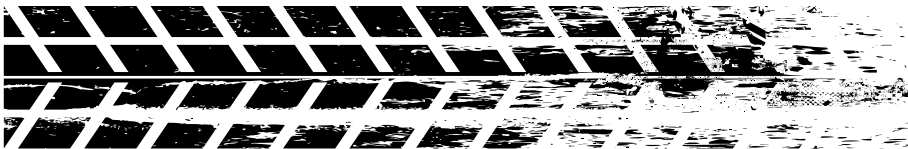

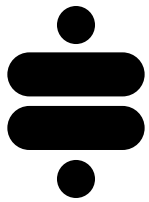

**Please Read And Understand All Instructions
And Warnings Prior To The Installation Of
This Product.**

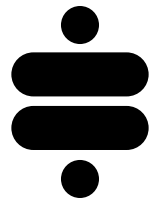

THANK YOU

Congratulations on your new Ridetech product! It's an honor that you've selected the Ridetech brand to upgrade your ride. Our products are developed around quality and performance without compromise. We're confident you'll have many years (and miles) of pure driving enjoyment.
Thank you for choosing Ridetech!

Road Map

Exploded View & Parts Listing	3
Bracket Installation	4
Caliper Installation	5

NOTE:

**This bracket kit is designed to be compatible with S550 ('15-'23)
Mustang rear brakes and Ridetech hub spindle.**

EXPLODED VIEWS AND PARTS LISTING

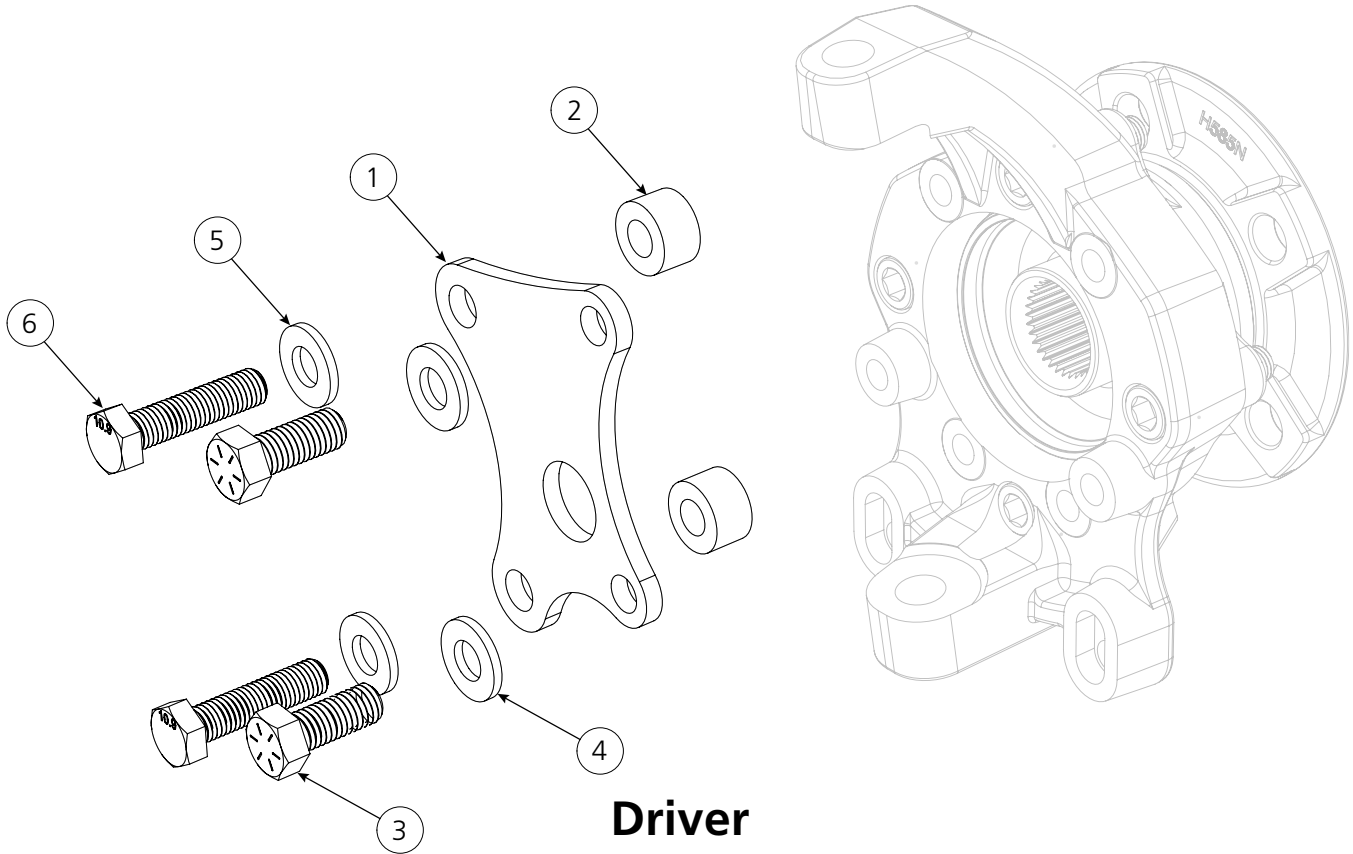

ITEM #	PART #	DESCRIPTION	QTY
1	90002962	CALIPER BRACKET DRIVER / PASSENGER	2
2	90002965	1.0" ID x 0.505" OD X 0.59" OAL , SPACER	4
	99010267	Hardware Kit	1
Hardware Kit: 99010267			
S550 BRACKETS TO SPINDLE			
3	99501062	1/2-13 X 1 1/4" HEX CAP SCREW GR 8	4
4	99503014	1/2 SAE FLAT WASHER GR8	4
S550 BRACKETS TO CALIPER			
5	99143001	M14 Flat Washer; Grade 10.9	4
6	99141008	M14-2.0 x 50mm Hex Bolt Grade 10.9	4
SHIM PACK			
7	99503018	1/2 MIL. SPEC. WASHER (THICKNESS .016")	4
8	99503019	1/2 MIL. SPEC. WASHER (THICKNESS .032")	4
9	99563005	9/16 MIL. SPEC. WASHER (THICKNESS .016")	4
10	99563006	9/16 MIL. SPEC. WASHER (THICKNESS .032")	4

Bracket Installation

NOTE: We recommend mocking up the brake assembly with clean, dry threads before applying loctite to any threads and torquing for final assembly.

1. Position the bracket on the back side of the spindle. The raised boss on the spindle should align with the large hole in the bracket, and the bolt holes on the shorter end of the bracket should align with the mounting holes in the spindle (Figure 1).

2. Attach the bracket to the spindle with (2) 1/2"-13 x 1.25" bolts with flat washers as shown in Figure 2.

Torque to **90 ft-lbs.**

3. Once the caliper bracket is mounted and torqued, torque the axle nut (Figure 3). Refer to the torque specifications for your particular axle shaft. A prybar wedged between the wheel studs works well to keep the axle from turning.

If you have installed the Ridetech axles (12129599), torque the axle nut to **98 ft-lbs plus 45°** of additional rotation (stretch).

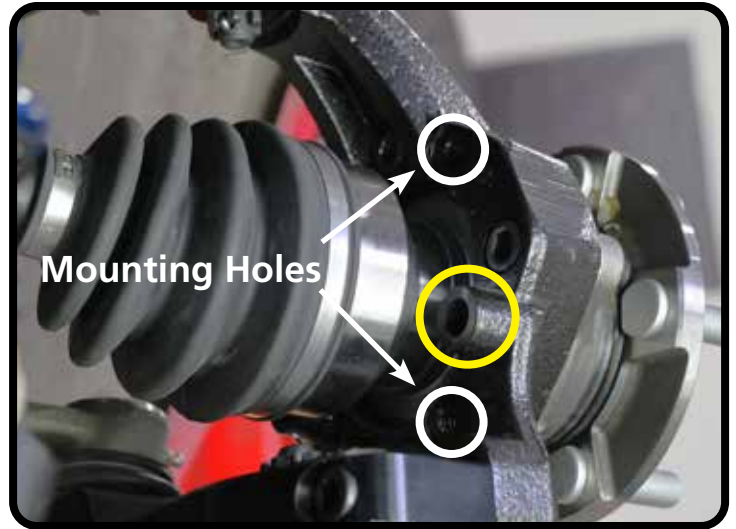

Figure 1



Figure 2



Figure 3

Caliper Installation

4. Install the brake rotor and temporarily secure with a couple of lug nuts (Figure 4).

5. Mount the brake caliper mount to the caliper bracket with (2) M14-2.0 x 50mm bolts and M14 washers. Insert a 90002965 spacer on each bolt, between the caliper bracket and the caliper mount (Figure 5).

Torque to **126 ft-lbs.**

NOTE: This kit includes a set of shims to aid in centering the caliper mount on the rotor if necessary. The provided shims are in two different thicknesses (.016" and .032").

To push the caliper mount outward, insert 9/16" shim washers next to the spacers shown in Figure 5.

To pull the caliper mount inward, insert 1/2" shim washers on the bolts from step 2, between the Ridetech bracket and the spindle.

6. Install the brake caliper and pads.

7. Finish plumbing the brake system and bleed the system.



Figure 4

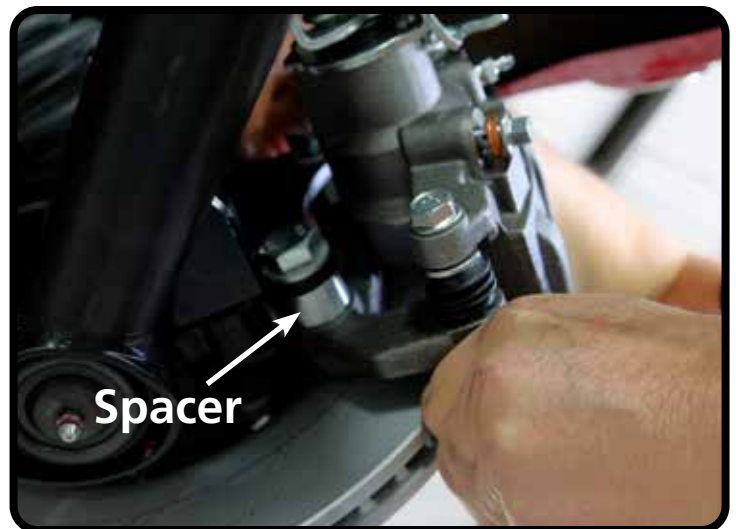

Figure 5