

Important: Please read instructions completely before installing wheel spacer - adaptor.

Part numbers:

- 15201.02 - (Spacer 1.25") Designed for 1987-2006 Jeep® vehicles with 5 x 4.5" bolt pattern.
- 15201.08 - (Spacer 1.50") Designed for 1987-2006 Jeep® vehicles with 5 x 4.5" bolt pattern.
- 15201.03 - (Spacer 1.25") Designed for 1945-1986 Jeep® vehicles with 5 x 5.5" bolt pattern.
- 15201.09 - (Spacer 1.50") Designed for 1945-1986 Jeep® vehicles with 5 x 5.5" bolt pattern.
- 15201.05 - (Spacer 1.50") Designed for 2007- UP Jeep® vehicles with 5 x 5" bolt pattern.
- 15201.06 - (Adaptor 1.375") Designed for 2007- Up Jeep® vehicles with 5" lug spacing to 4.5".
- 15201.07 - (Adaptor 1.375") Designed for 2007- Up Jeep® vehicles with 5" lug spacing to 5.5".
- 15201.04 - (Adaptor 1.25") Designed for 1987-2006 Jeep® vehicles with 4.5" lug spacing to 5.5".
- 15201.10 - (Adaptor 1.375") Designed for 1987-2006 Jeep® vehicles with 4.5" lug spacing to 5.5".
- 15201.11 - (Adaptor 1.375") Designed for 1987-2006 Jeep® vehicles with 4.5" lug spacing to 5".

- Kit content:** (2) T6 Aluminum spacer or adaptor
 (10) Grade 8 Wheel Stud (pre-pressed)
 (10) Lug Nuts

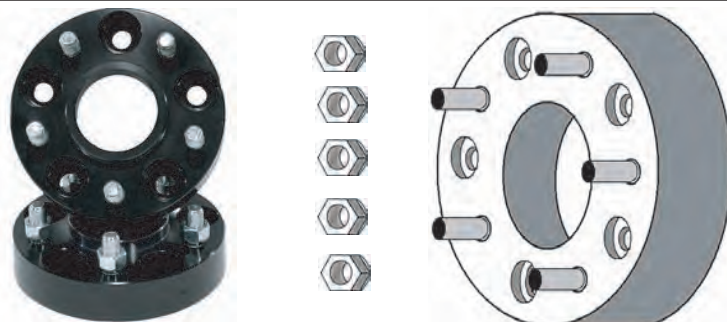

(1) Remove tire using the proper procedures called out in the Jeep® service manual

(2) Remove any retainer clips from the mating surface of drums and or rotors.

WARNING: It is very important that all retainer clips be removed before installing spacers or adaptors. Surface of rotor or drum must be cleaned. All mud, dirt, rust and or scaling must be removed before spacer or adaptor can be installed. Failure to follow instructions may not allow spacer or adaptor to be properly tightened.

(3) Clean wheel studs with wire brush. Apply a quality thread lock to axle wheel studs.

(4) Thread supplied lug nuts to axle studs with tapered end oriented to toward spacer- adaptor. Tighten lug nuts in a crisscross pattern. Set torque to 85-100 ft-lbs. It will help to have another person holding the brake pedal when tightening.

WARNING: Attach spacer - adaptor using supplied lug nuts only. Make sure axle studs clear spacer - adaptor and allow full engagement of lug nut threads.

NEVER DOUBLE STACK wheel spacer-adaptors. you can be **KILLED** or **SERIOUSLY HURT** if warning is ignored.

(5) Clean and remove any dirt, rust or scaling from mating surface of road wheel. Reinstall tire to spacer - adaptor with factory lug nuts. Tighten to factory specifications.

