



## INSTALLATION GUIDE: AWE EXHAUST SUITE FOR THE FORD BRONCO

For up-to-date fitment information, please visit the product page on [AWE-Tuning.com](https://www.awe-tuning.com).

### THIS GUIDE IS INTENDED FOR THE FOLLOWING PART NUMBERS:

- 3015-32456 AWE 0FG Catback Exhaust for Ford Bronco with BashGuard - Dual 4.5" Chrome Silver Tips
- 3015-33456 AWE 0FG Catback Exhaust for Ford Bronco with BashGuard - Dual 4.5" Diamond Black Tips
- 3015-22789 AWE 0FG Catback Exhaust for Ford Bronco with BashGuard - Single 5" Chrome Silver Tip
- 3015-23789 AWE 0FG Catback Exhaust for Ford Bronco with BashGuard - Single 5" Diamond Black Tip
- 3015-21000 AWE 0FG Catback Exhaust for Ford Bronco with BashGuard - No Tips

Welcome to the AWE family, and congratulations on your purchase of the AWE Exhaust System for the Ford Bronco.

Exquisite build quality and craftsmanship, coupled with industry leading performance, distinguish this exhaust system from all others.

\*For up to the minute fitment information, be sure to visit our website. As always, AWE Performance Specialists are standing by for any questions, [right here](#).

# PARTS LIST (DUAL EXIT)



Inspect **ALL** parts prior to disassembly of vehicle; If damaged or **MISSING**, please contact the place of purchase immediately.

Symbol	Part Number	Description	QTY
	E34	Resonated Inlet Section	1
	E35	4 Door Length Adapter	1
	E36	Overaxle Tube	1
	E38	Bash Guard	1
	E39	Dual Rear Exit Section	1
	E40	2.3L to 2.7L Hanger Adapter	1
<b>A</b> >>		AWE Band Clamp: 3"	3
<b>B</b> >>		CLAMP-KIT	1
<b>C</b> >>		Medium-Strength Steel Serrated Flange Locknut Class 8, M8 x 1.25 mm Thread	2
<b>D</b> >>		77mm Inlet, 114mm OD, Integrated clamp, Chrome Silver	2
		4.50" OD x 3.00" ID, Slash Cut, Diamond Black, AWE Logo, Intergrated Clamp	2

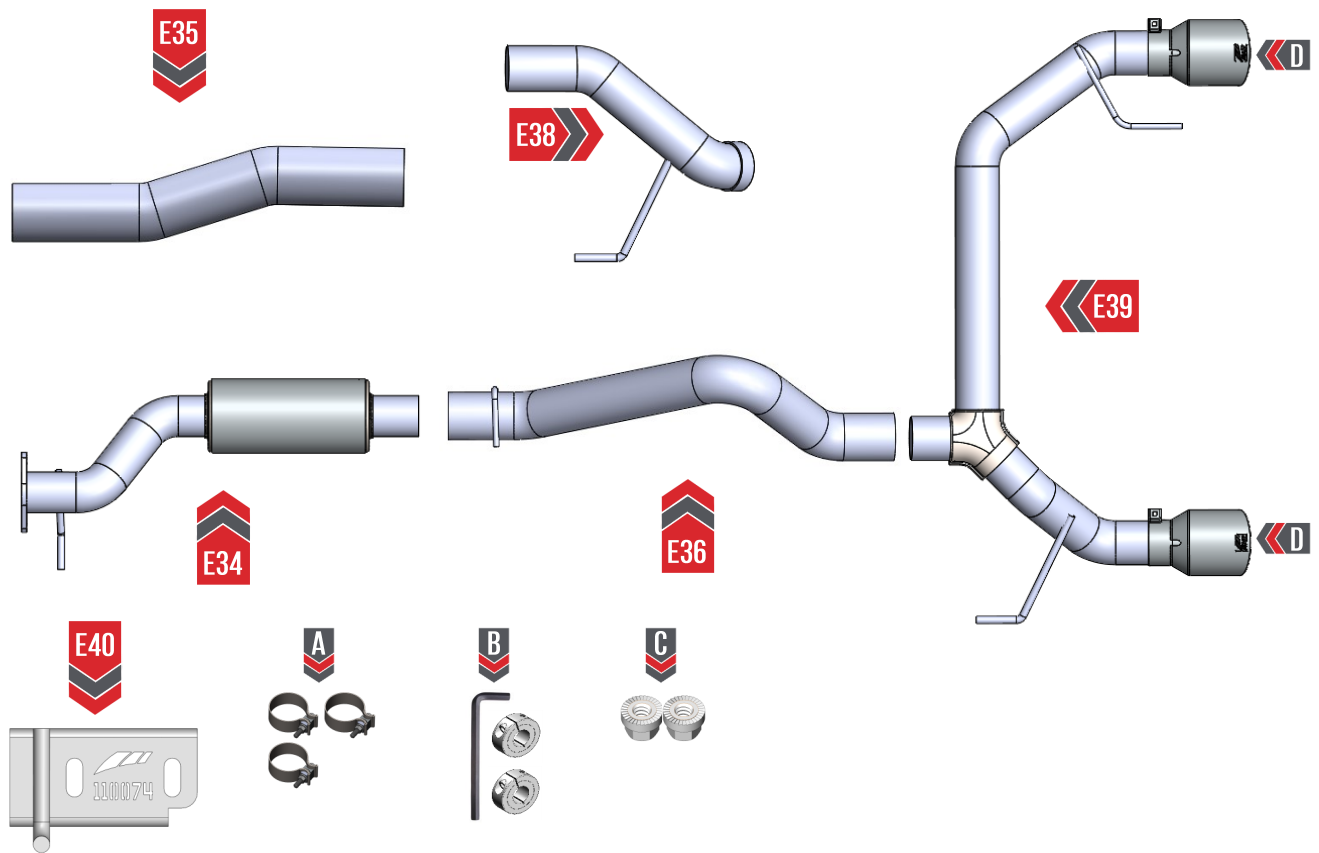

# PARTS LIST (SINGLE EXIT)



Inspect **ALL** parts prior to disassembly of vehicle; If damaged or **MISSING**, please contact the place of purchase immediately.

Symbol	Part Number	Description	QTY
	E34	Resonated Inlet Section	1
	E35	4 Door Length Adapter	1
	E36	Overaxle Tube	1
	E37	Single Outlet	1
	E38	Bash Guard	1
<b>A</b> >>		AWE Band Clamp: 3"	3
<b>B</b> >>		CLAMP-KIT	1
<b>C</b> >>		Medium-Strength Steel Serrated Flange Locknut Class 8, M8 x 1.25 mm Thread	2
<b>D</b> >>		5.00" OD x 3.00" ID, Stright Cut, Diamond Black, AWE logo, Integrated Clamp	1
<b>D</b> >>		5.00" OD x 3.00" ID, Stright Cut, Chrome Silver, AWE logo, Integrated Clamp	1

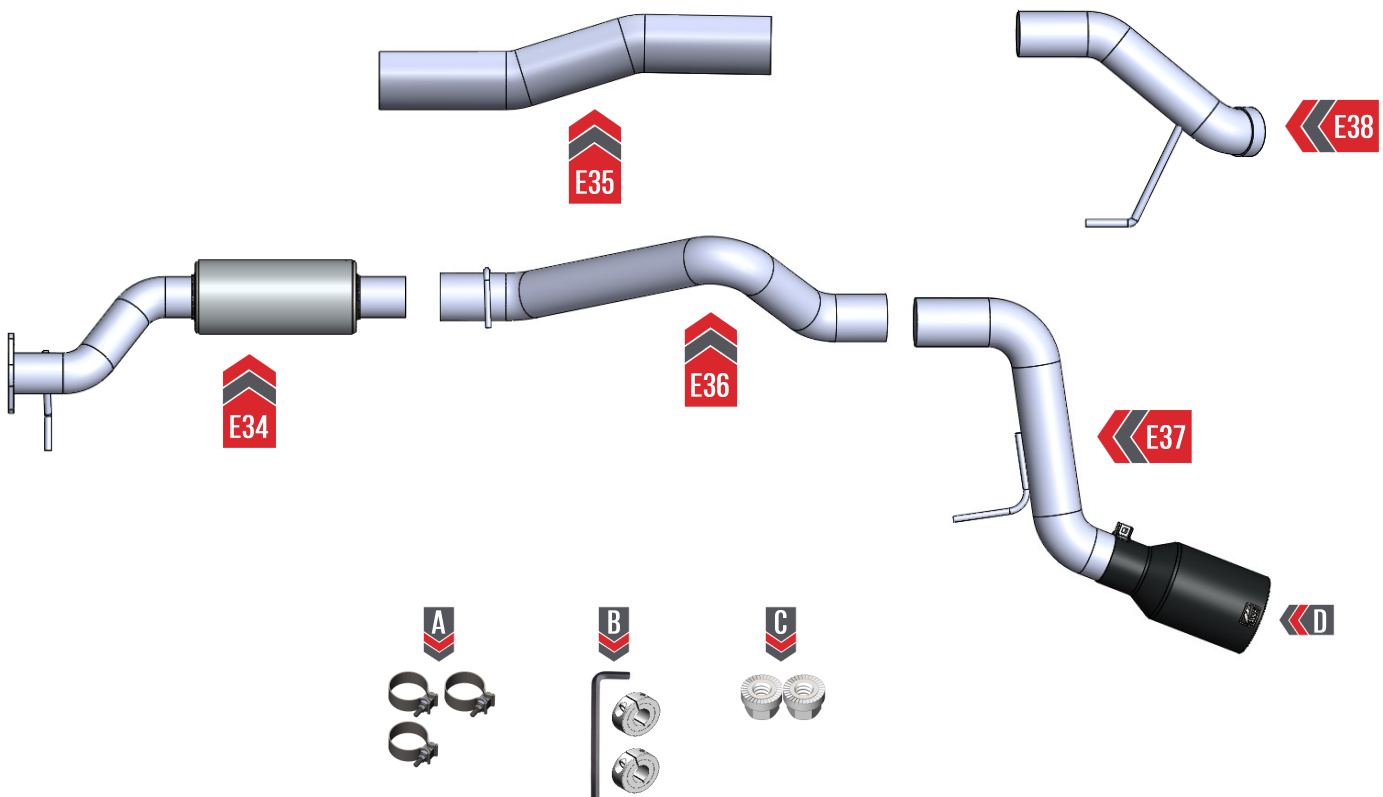

# PARTS LIST (BASHGUARD)



Inspect **ALL** parts prior to disassembly of vehicle; If damaged or **MISSING**, please contact the place of purchase immediately.

Symbol	Part Number	Description	QTY
	E34	Resonated Inlet Section	1
	E35	4 Door Length Adapter	1
	E36	Overaxle Tube	1
	E38	Bash Guard	1
<b>A</b> >>		AWE Band Clamp: 3"	3
<b>B</b> >>		CLAMP-KIT	1
<b>C</b> >>		Medium-Strength Steel Serrated Flange Locknut Class 8, M8 x 1.25 mm Thread	2

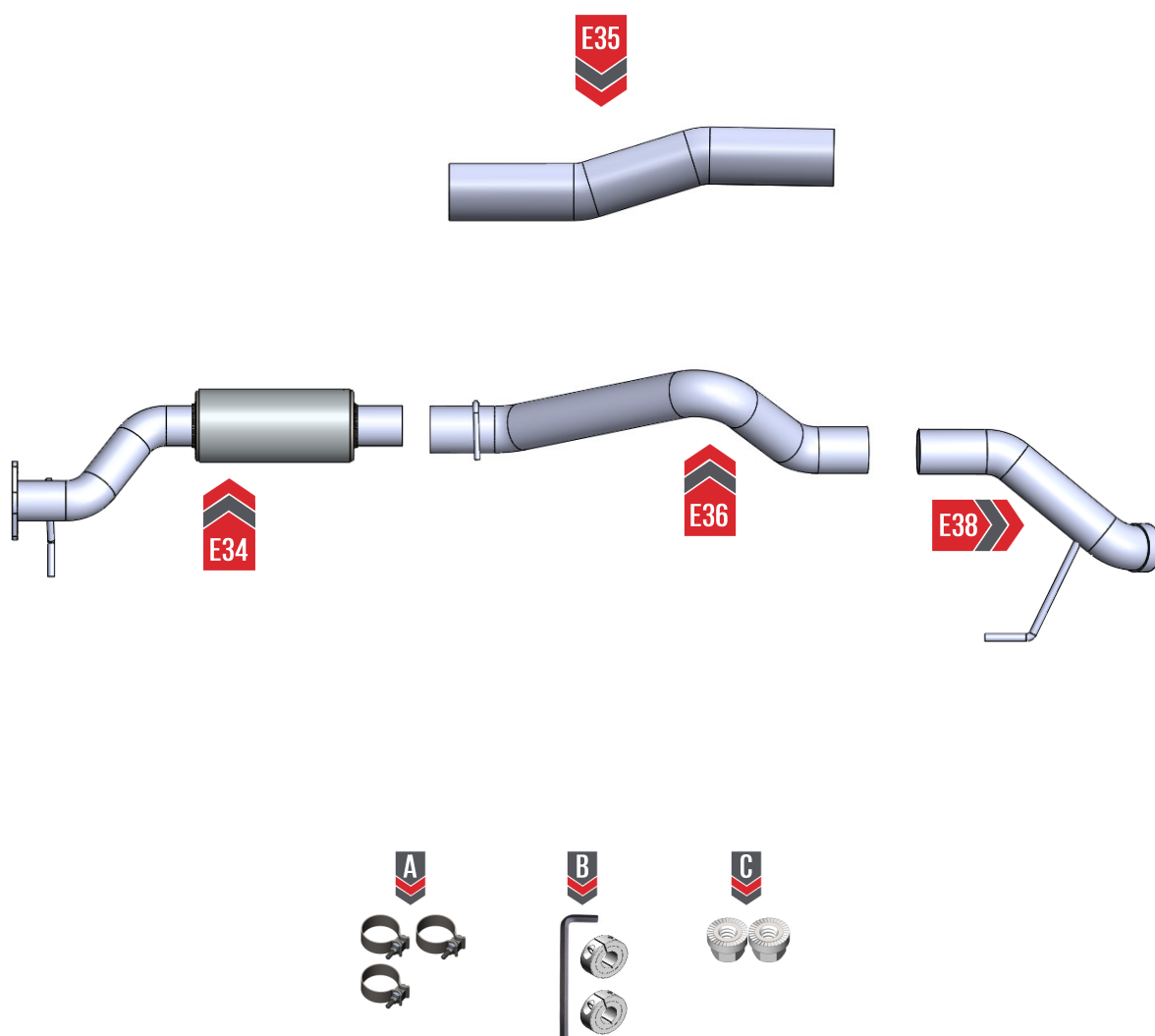



**NOTE:** Always refer to the manufacturer's service manual for precise torque specifications on all OEM fasteners.



**CAUTION:** The exhaust may be **VERY HOT** — allow adequate time for the system to cool down before disassembly. Severe burns and injury will occur if skin comes into contact with a hot exhaust system.

## STEP 1

Start by removing the OE Bronco exhaust by following the steps, shown in **Figure 1**.



Soak all bolts, and hangers in penetrant fluid before working.

1. Start by removing the OE flange bolts at arrow **(A)**.
2. Next remove the 2 OE bolts holding the OE hanger onto the frame, at arrow **(B)**.
3. Loosen the clamp at arrow **(C)**, and detach the OE exhaust from the OE hanger above the axle at arrow **(D)**. This will allow you to remove the OE midpipe section.
4. Lastly detach the OE muffler section from the OE hangers at arrow **(E)**.

**Note:** The OE flange bolts, and hanger bolts will be re-used

**Note:** All of the OE rubber hangers will be reused.

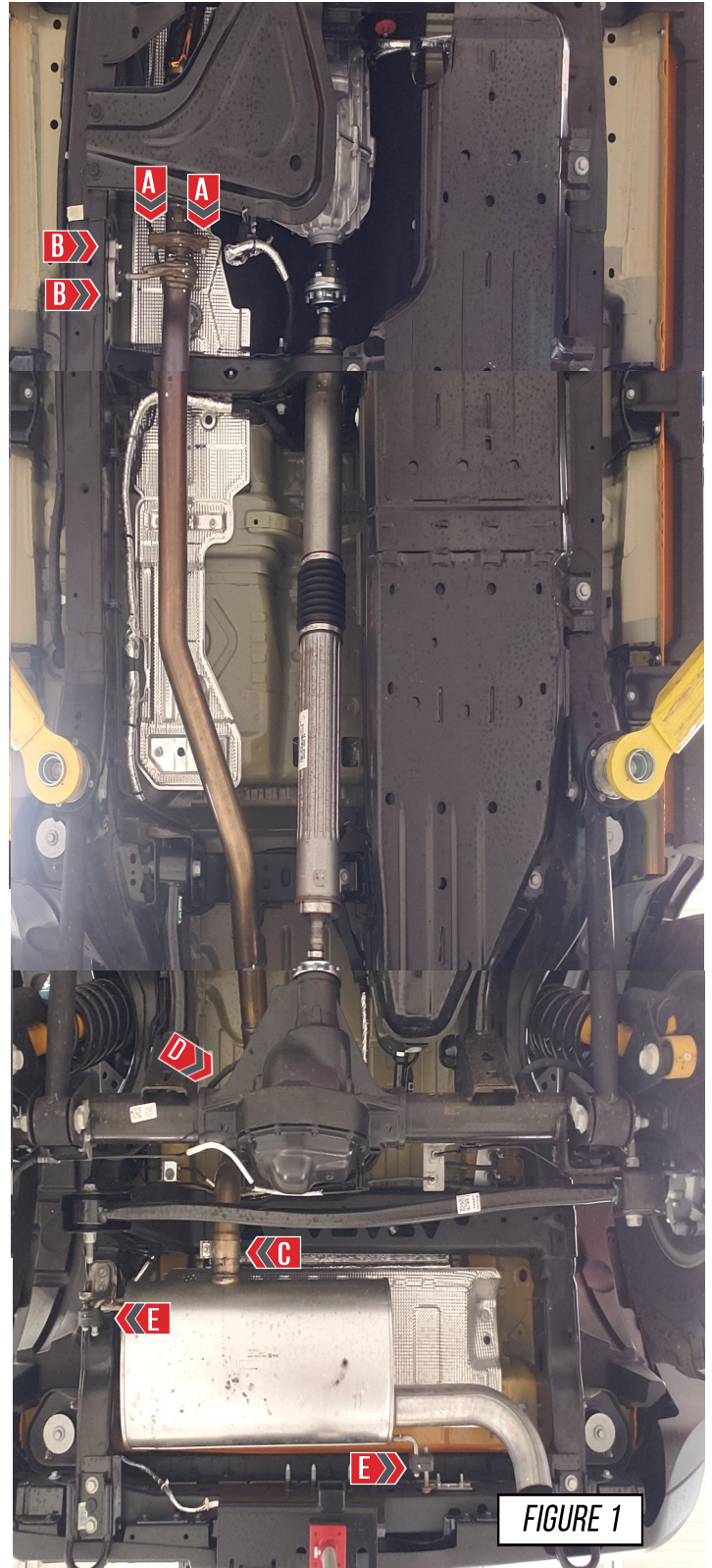

FIGURE 1

## STEP 2

Begin your install by gathering your AWE resonated inlet section (**E34**), and the OE front hanger as shown in **Figure 2**.

Insert the OE hanger on to your AWE hanger barb, as shown at (**A**) in **Figure 2**.

**Note:** The pin on the OE hanger, shown at (**B**) in **Figure 2** should be on the top side of the OE hanger.

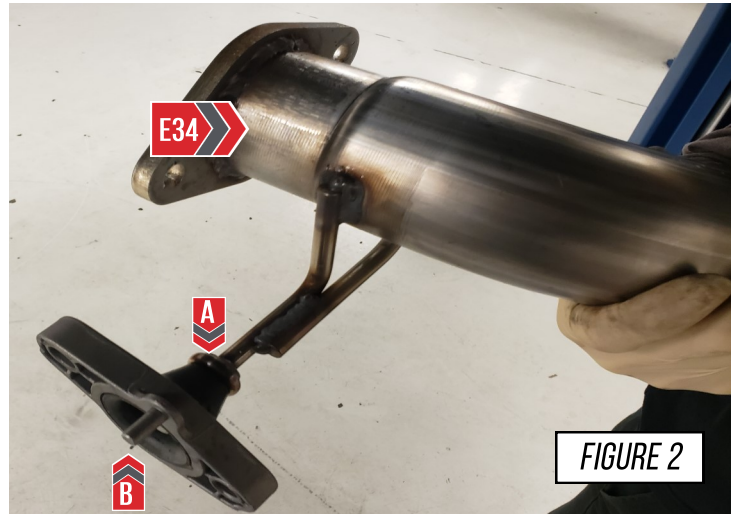

FIGURE 2

## STEP 3

Install your AWE resonated inlet section (**E34**) by first aligning the pin on the OE hanger into the frame (**A**). Next, attach your inlet section to the OE front pipe, using the OE hardware (**B**), as shown in **Figure 3-1**.

With the flange hardware in place use the OE hanger hardware to secure the OE hanger to the frame as shown in **Figure 3-2**.



**Fully tighten all hardware before moving on to the next step.**

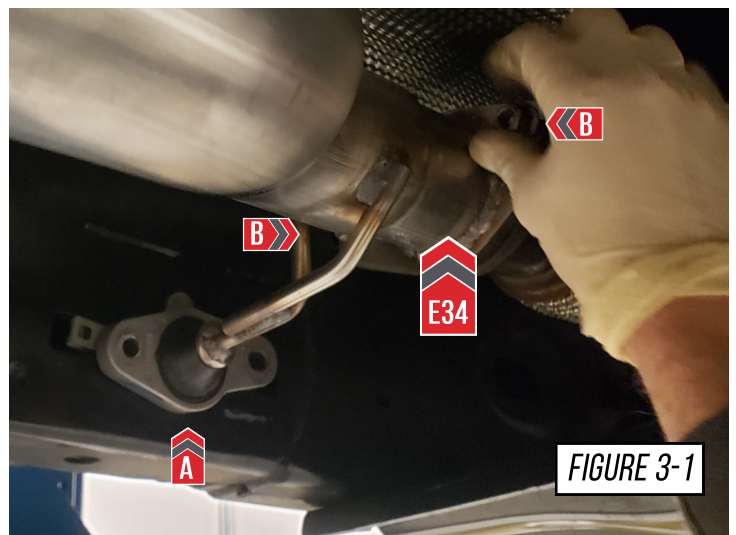

FIGURE 3-1

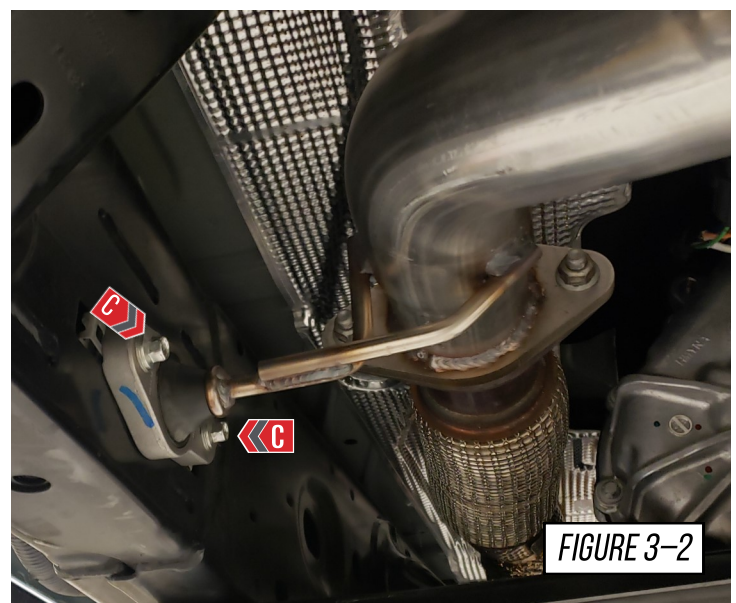

FIGURE 3-2

## STEP 4

### STEP 4 IS FOR 4 DOOR VEHICLES ONLY.

Install your AWE 4 Door length adapter (**E35**). Slide a provided clamp over the AWE inlet section (**E34**) and bottom out the 4 door adapter as shown in **Figure 4**.

Snug the clamp but do not fully tighten it at this time.



It is crucial that the bend in the adapter faces away from the driveshaft.

**Note:** The rotation of this tube will be adjusted for final fitment of the exhaust tips.

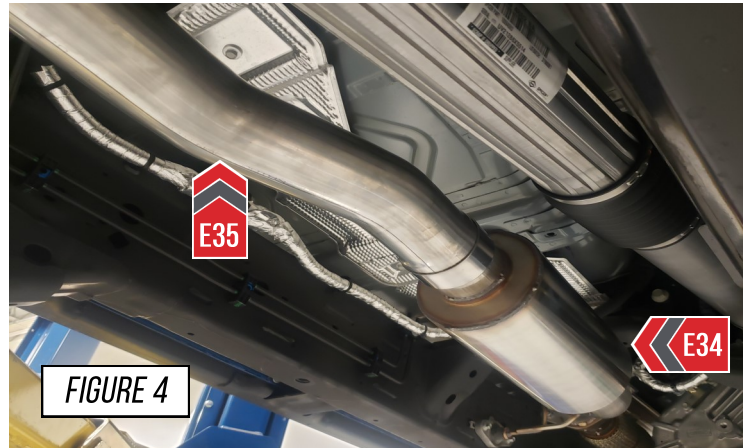

## STEP 5

It is crucial to install each section and exhaust band clamps correctly to prevent loose joints, exhaust leaks and rattles.

**Arrow A** shows the expanded pipe and the preinstalled exhaust clamp being brought up to the corresponding pipe.

**Arrow B** shows the overlapping pipe installed correctly over the corresponding pipe.

**Arrow C** shows the exhaust band clamp being brought to the edge of the expanded pipe.



#### NOTES:

- **Do not** fully torque any exhaust clamp until the entire exhaust has been installed and adjusted.
- Torque specification is a **minimum** of 60 ft/lbs

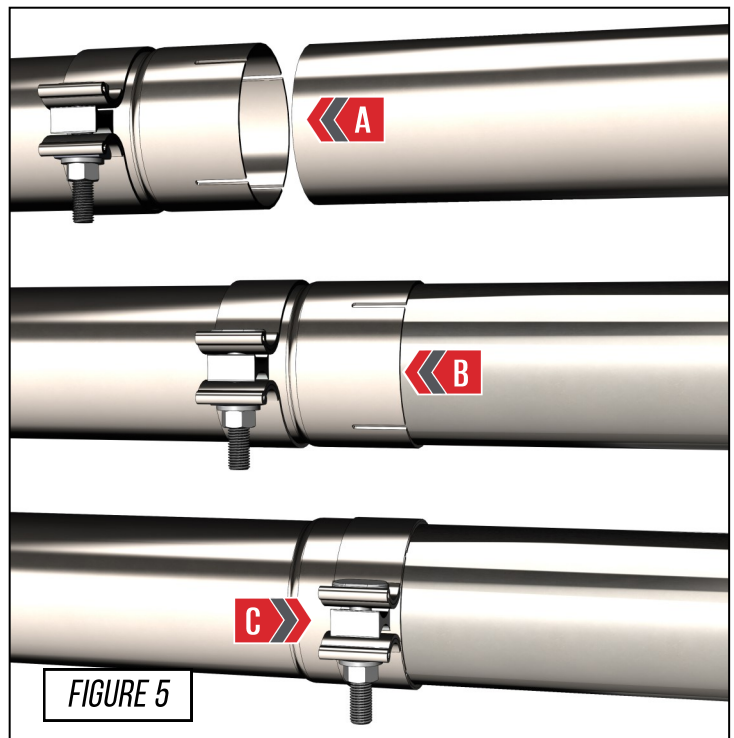

## STEP 6

Install your AWE overaxle tube (**E36**) by first putting a clamp on your inlet pipe (**E34**) or 4 door adapter (**E35**), then bottom out the AWE overaxle tube slip joint, shown in **Figure 6-1**.

**Note:** **Figure 6-2** displays lock collar locations for the dual exit system. **Figure 6-3** shows lock collar positions for the single exit system.

### Dual system:

Before inserting the hanger bar into the OE hanger slide one lock collar clamp onto the hanger bar so it is positioned on the bar, as shown at **(A)** in **Figure 6-2**.

Next slide the hanger bar into the OE hanger, and place the second lock collar on the bar, as shown **(B)** in **Figure 6-2**.

Snug the clamp, and lock collars but do not fully tighten it at this time.

### Single exit system

Slide the hanger bar into the OE hanger, and place a lock collar on the bar, as shown at **(C)** in **Figure 6-3**.

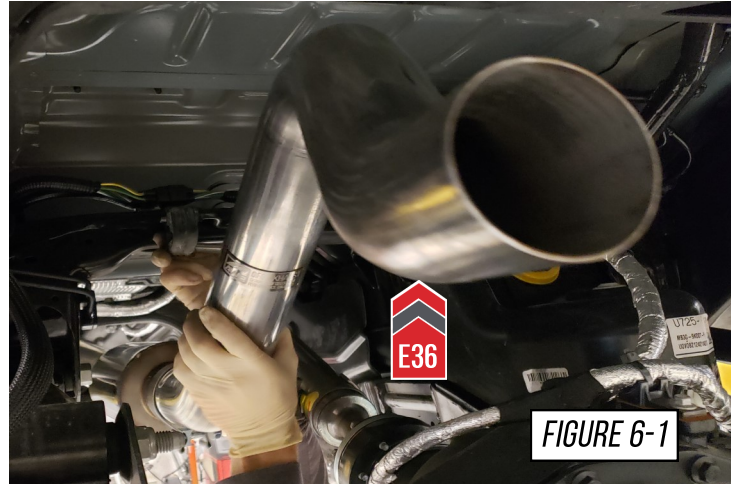

FIGURE 6-1

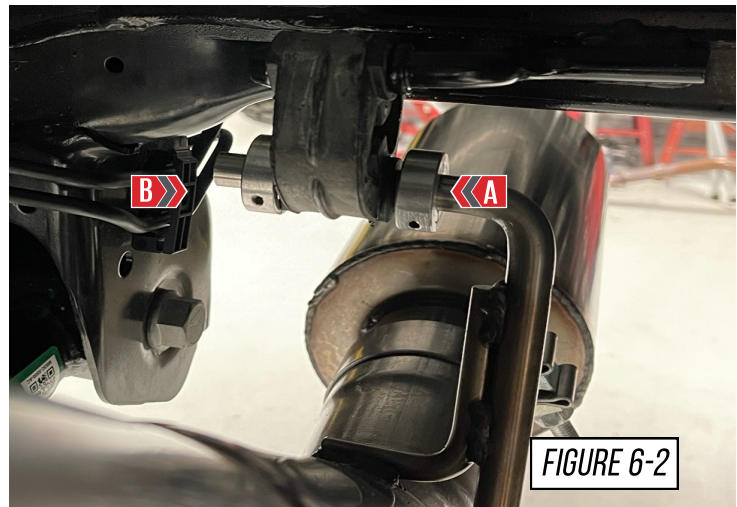

FIGURE 6-2

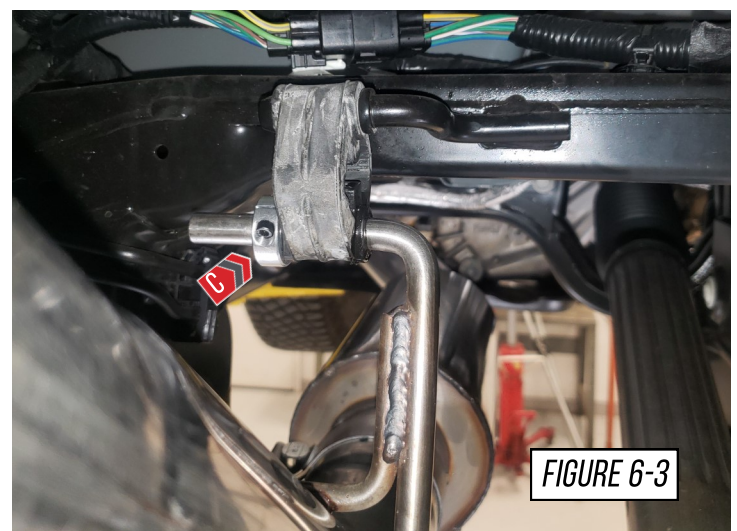

FIGURE 6-3



## STEP 7 IS THE STARTING POINT FOR THE DUAL EXIT SYSTEMS



### STEP 7

Now install your AWE single outlet tube (**E37**), by first sliding a clamp on your AWE Overaxle tube (**E36**), then bottom the single outlet tube out on the Overaxle tube, as shown at (**A**) in **Figure 7**.

Next slide the hanger bar into the OE hanger (**B**) as shown in **Figure 7**.

Lastly snug the clamp on the slip joint but do not fully tighten it at this point.

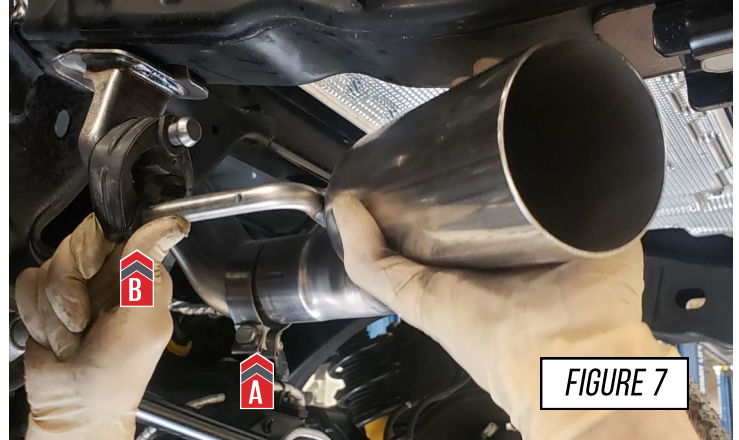

### STEP 8

For the best tip fitment, align the barrel style tip clamp to cover *only* the slot, shown by **Arrow A**

Torque the tip clamp to 18 ft./lbs.



#### NOTES:

- It is required to apply anti-seize to the threads to prevent thread binding, shown by **Arrow B**
- It is okay to have the clamp extend beyond the edge of the tip inlet.

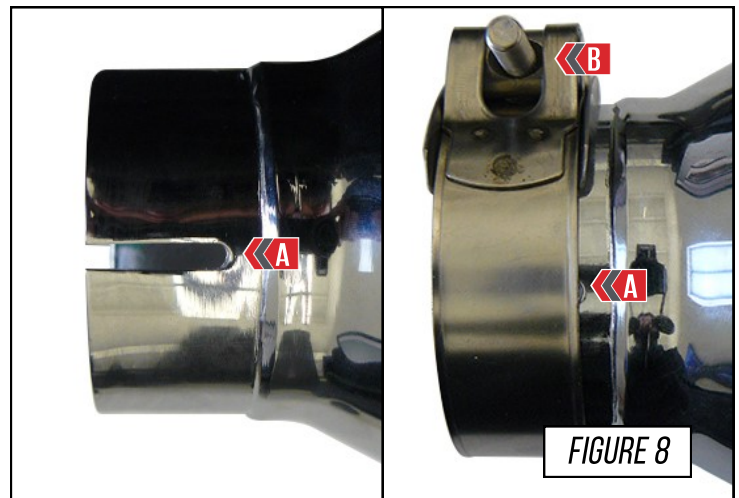

## STEP 9

Install your AWE tip by sliding a clamp onto your AWE single outlet tube (E37) then slide the tip onto the outlet tube. Place it in the desired location and snug the clamp over the slip joint (A).

When installing your tip it is important to make sure that there is 1/2" to 5/8" of space between the tip and the OE tow hook (B), as shown in Figure 9.

**Note:** If adjustments are required to achieve this fitment, slide the over axle tube hanger bar towards the driver's side frame rail. Refer to Figure 6-3.

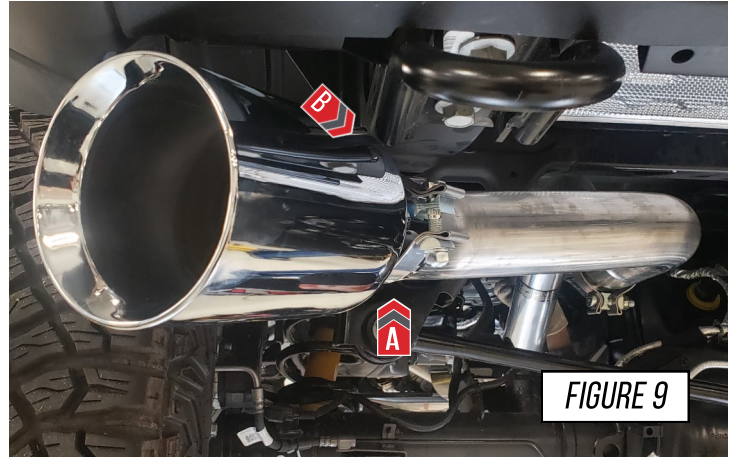

## STEP 10

Working from the front of the vehicle to the back, fully tighten all clamps to a minimum of 60 Ft/Lbs. Ensure there is proper fitment and clearance to all parts and body panels.

It is now recommended to drive the car to allow the exhaust to heat cycle after all clamps and tips are fully tightened.

 At this point the exhaust will be **very hot**, allow to cool before work continues.

Check the tips for correct alignment, adjust as needed.

 Don't forget to look below for any troubleshooting needs!



# ENJOY!



10



## STEP 11 IS THE STARTING POINT FOR THE DUAL EXIT SYSTEMS



### STEP 11

#### 2.3L vehicles only.

Install your AWE 2.3L– 2.7L adapter (**E40**), as shown in **Figure 11**. Use the provided hardware to mount the adapter over the OE hanger bracket.

Next remove the OE hanger gromet and install it on the AWE adapter bracket (**E40**).

**Note:** The slotted bolt holes will be used for adjustment to achieve desired fitment.

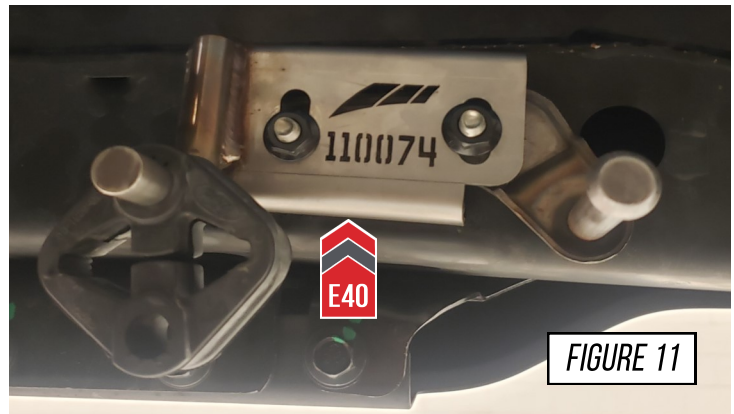

### STEP 12

To install your AWE dual rear exit section (**E39**), start by slipping the hanger bars into the OE hangers shown at (**A**) in **Figure 12**.

Next slide a provided clamp over the dual rear exit section (**B**) then bottom out your AWE rear exit section (**E39**) on your AWE overaxle tube (**E36**). Snug the clamp over the slip fit but do not tighten it all the way.

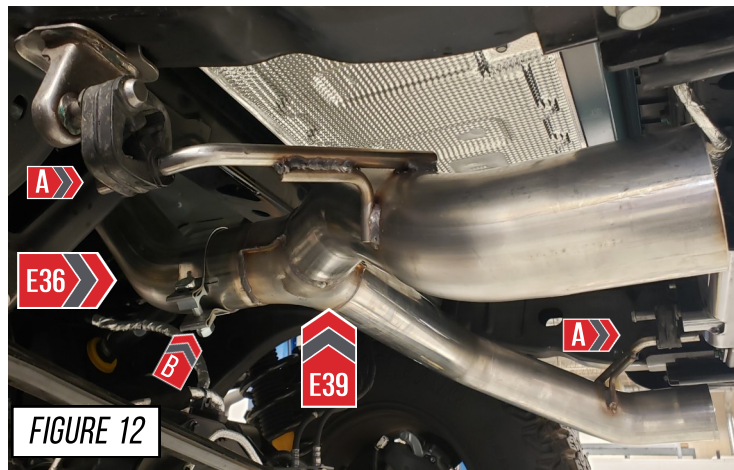

### STEP 13

Gather your AWE exhaust tips, and slide them on your AWE dual rear exit section (**E39**) tube, as shown in **Figure 13**.



## STEP 14

To install the exhaust tips with integrated clamps, first, attach the exhaust tip in the proper orientation onto the exhaust outlet tube.

Insert one of the carriage bolts from the hardware kit (**3910-41010**) through the tab on the exhaust tip and thread on one of the corresponding nuts.

Using anti-seize on the bolt threads will help installation and prevent breakage of hardware.

 The integrated clamp kit has enough hardware for our 4 tip exhaust systems. You will have 2 sets of hardware left over that will not be used.

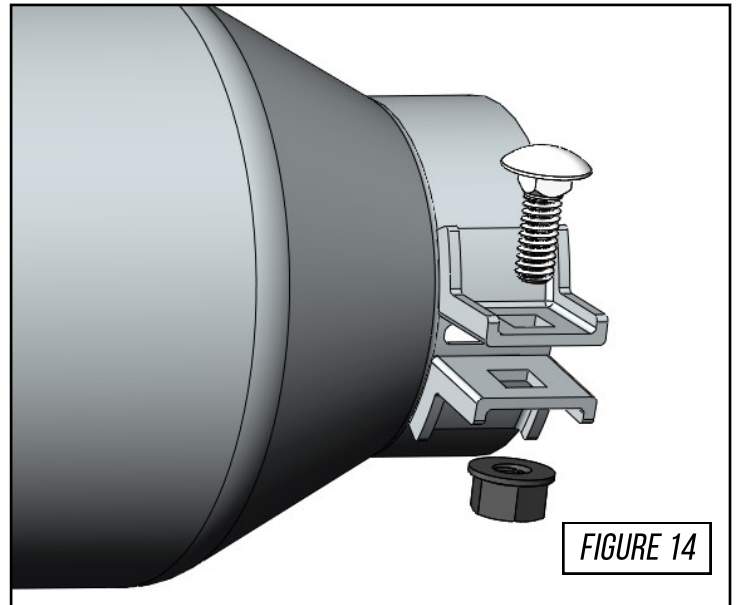

## STEP 15

Working from the front of the vehicle to the back, fully tighten all clamps to a minimum of 60 Ft/Lbs. Ensure there is proper fitment and clearance to all parts and body panels.

It is now recommended to drive the car to allow the exhaust to heat cycle after all clamps and tips are fully tightened.

 At this point the exhaust will be **very hot**, allow to cool before work continues.

Check the tips for correct alignment, adjust as needed.

 Don't forget to look below for any troubleshooting needs!

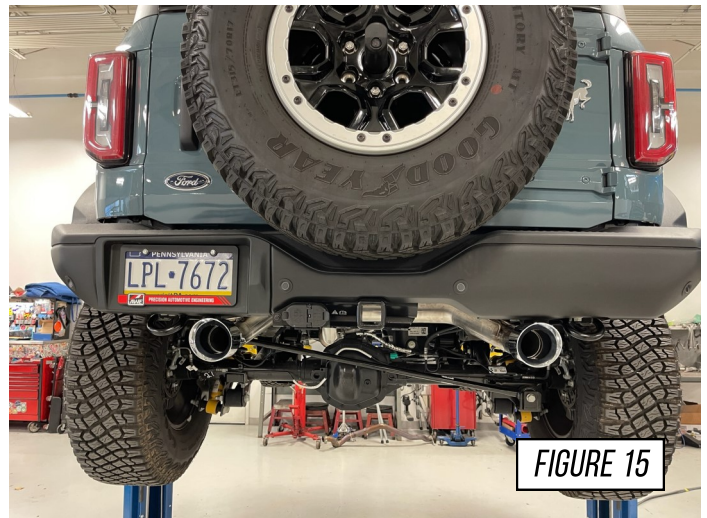

# ENJOY!





## STEP 17 IS THE STARTING POINT FOR THE BASHGUARD SYSTEM



### STEP 17

To install the AWE BashGuard, first gather the provided clamp and slide it onto the AWE overaxle tube (E36) (A).

Next insert the hanger bar into the OE hanger as shown at (B) in **Figure 17**.

Then, align the slip joint on the AWE BashGuard (E38) and bottom out the slip joint on the AWE overaxle tube (E36), as shown in **Figure 17**.

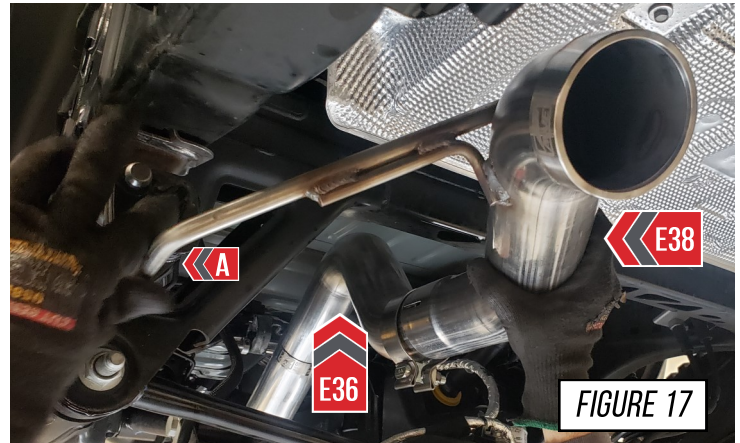

FIGURE 17

### STEP 18

Working from the front of the vehicle to the back, fully tighten all clamps to a minimum of 60 Ft/Lbs. Ensure there is proper fitment and clearance to all parts and body panels.

It is now recommended to drive the car to allow the exhaust to heat cycle after all clamps and tips are fully tightened.

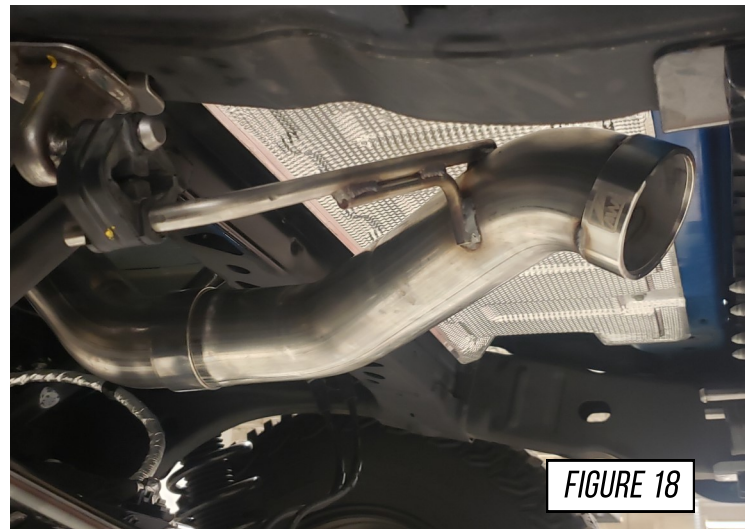

FIGURE 18



At this point the exhaust will be **very hot**, allow to cool before work continues.

Check the tips for correct alignment, adjust as needed.



Don't forget to look below for any troubleshooting needs!

# ENJOY!



# TROUBLESHOOTING

Issue	Solution
Exhaust is not fitting correctly	Most fitment issues are due to improperly adjusted exhaust. This includes tip fitments and rattling due to chassis contact. Check out our <a href="#">fitment guide</a> for more installation tips.
Incorrect or missing parts	Double check the parts list for your system and compare them with what you received. Fill out our contact form, found below and let us know what parts you need.

# CARE

Once installed properly, your AWE exhaust will provide years of trouble-free performance.

The exhaust volume and sound will settle with usage; 800-1000 miles is required to break-in new exhaust systems.

Also, please note that the rear **180Technology**® resonator has a small drain hole to allow condensation to escape. Water drops from this area are normal.

Periodic cleaning of exhaust tips is necessary to maintain proper finish, especially in areas prone to road salt and caustic deicing solutions. Use a mild soap and water solution or car wax to clean the finish. Avoid using abrasive polishes, as they can scratch the finish.

Any questions or comments,  
please do not hesitate to contact us:

**AWE**  
215-658-1670  
[CONTACT FORM](#)

# WARRANTY

Up-to-date warranty information is found [HERE](#).