



Installation Instructions Mastershift 3-Speed Manual Shifter

To be used with Shifter Installation Kit, Sold Separately
See Application Guide for Specific Vehicles
Catalog# 3666809

WORK SAFELY: Perform this on a good clean level surface for maximum safety and with the engine turned "off". Apply parking brake and place blocks or wedges in front of and behind both rear wheels to prevent movement in either direction.

CAUTION: To avoid any possibility of bodily injury or damage to vehicle, do not attempt disconnect or installation until you are confident that the vehicle is safely secured and will not move.

1. Locate the position of the stick by estimating. Stick position should be located mid-way between the instrument panel and the seat when it is in NEUTRAL. (Seat should be at normal adjustment for driver.) The shifter housing pivots on its top mounting bolt. Pivot adjustment determines the stick position. Tighten both of the mounting bolts after the adjustment is made satisfactorily.

NOTE: The stick must be in its NEUTRAL position while this adjustment is made. A 1/4" drill bit inserted through the shifter frame and levers will secure the levers and the stick at NEUTRAL.

FIGURE 1

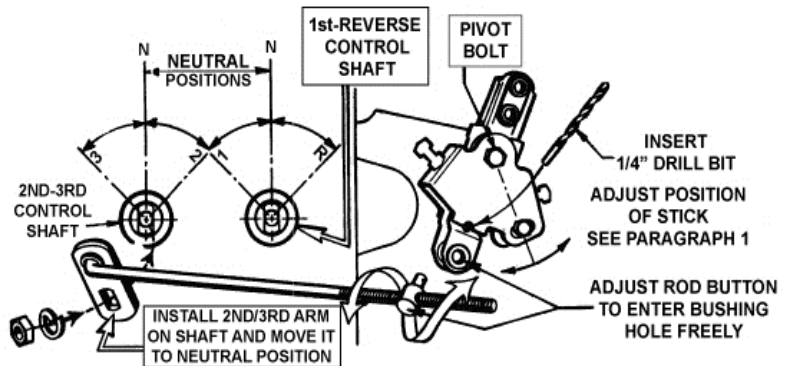

2. Install the 2nd – 3rd arm on the transmission control shaft. Fasten the arm to the shaft with the stock hardware. Assemble the proper rod to the arm with a bushing and fasten with a spring clip. With bushings installed, rod adjusting buttons must be adjusted to fit freely into the holes in the levers. Fasten the button with a spring clip.

FIGURE 2

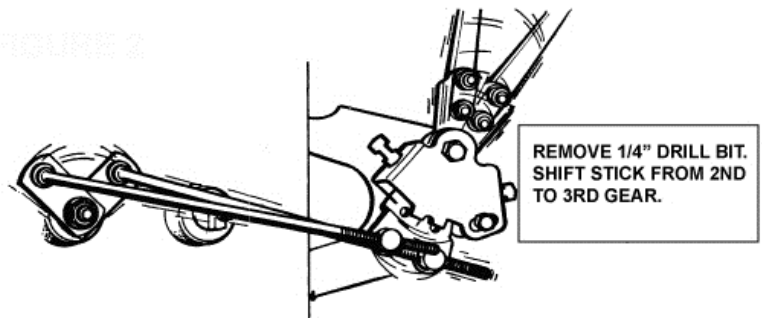

3. Remove 1/4" drill bit from the shifter. Shift stick from 2nd to 3rd gear. If the stick moves too close to instrument pane or seat, disconnect the button from the shifter lever. Loosen the mounting bolts. Adjust the shifter position on its pivot mounting in the required direction to correct the problem. Tighten the mounting bolts. Return the stick to NEUTRAL and re-adjust the button on the rod for free fit. (Arm on the transmission control shaft must be at NEUTRAL.) Replace the spring clip.

FIGURE 3

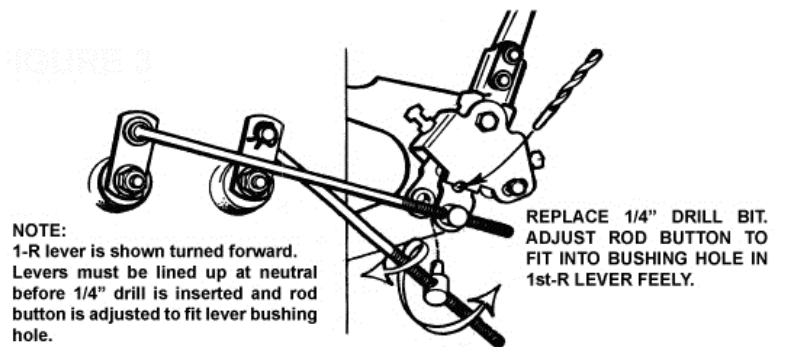

4. Install and fasten the 1st/REVERSE arm and rod assembly on the transmission control shaft. Turn both shifter levers to NEUTRAL and insert a 1/4" drill bit through them. Adjust the rod adjusting button so that it fits freely into the hole in the bushing. Fasten the button in the lever with a spring clip. Remove the 1/4" drill bit. Shift through all the gears. The stick should move smoothly through all gears. If any difficulty is encountered, the alignment must be checked. Replace the 1/4" drill bit and remove the buttons from the lever bushings. A button that does not withdraw freely requires adjustment.

5. Install the back-up light switch bracket under the 2nd gear stop bolt jam nut. Adjust the bracket slot position to allow 1/16" travel to remain when REVERSE lever is at the end of its travel. Adjust the 3rd gear stop bolt. Push the shifter stick firmly into 2nd gear and hold it there. Turn the stop bolt in one full turn beyond where contact is felt against the stick. Back the bolt out one half turn and tighten the jam nut. Repeat this procedure with the 3rd gear stop bolt (bolt at the front of the shifter frame).

IMPORTANT!

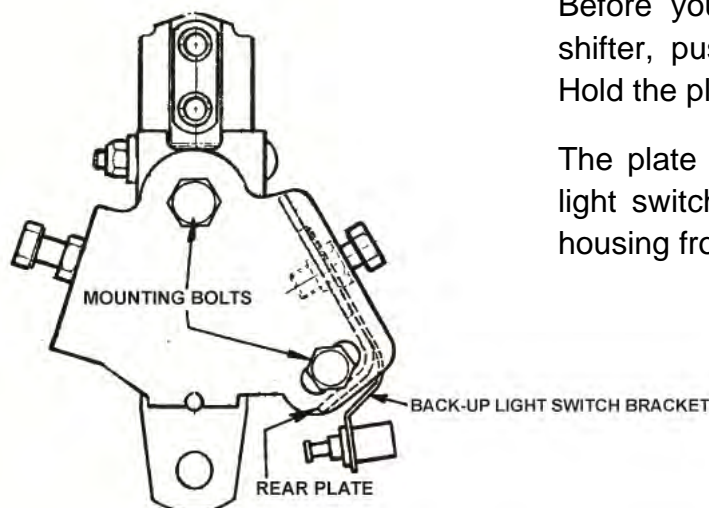

Before you tighten the lower mounting bolt through the shifter, push the rear cover plate in towards the shifter. Hold the plate in until you have tightened this bolt securely.

The plate must be in proper position to hold the back-up light switch bracket in position. The plate also keeps the housing from collapsing when mounting bolts are tightened.

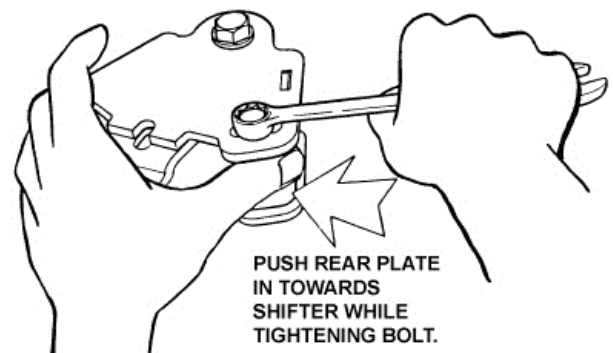

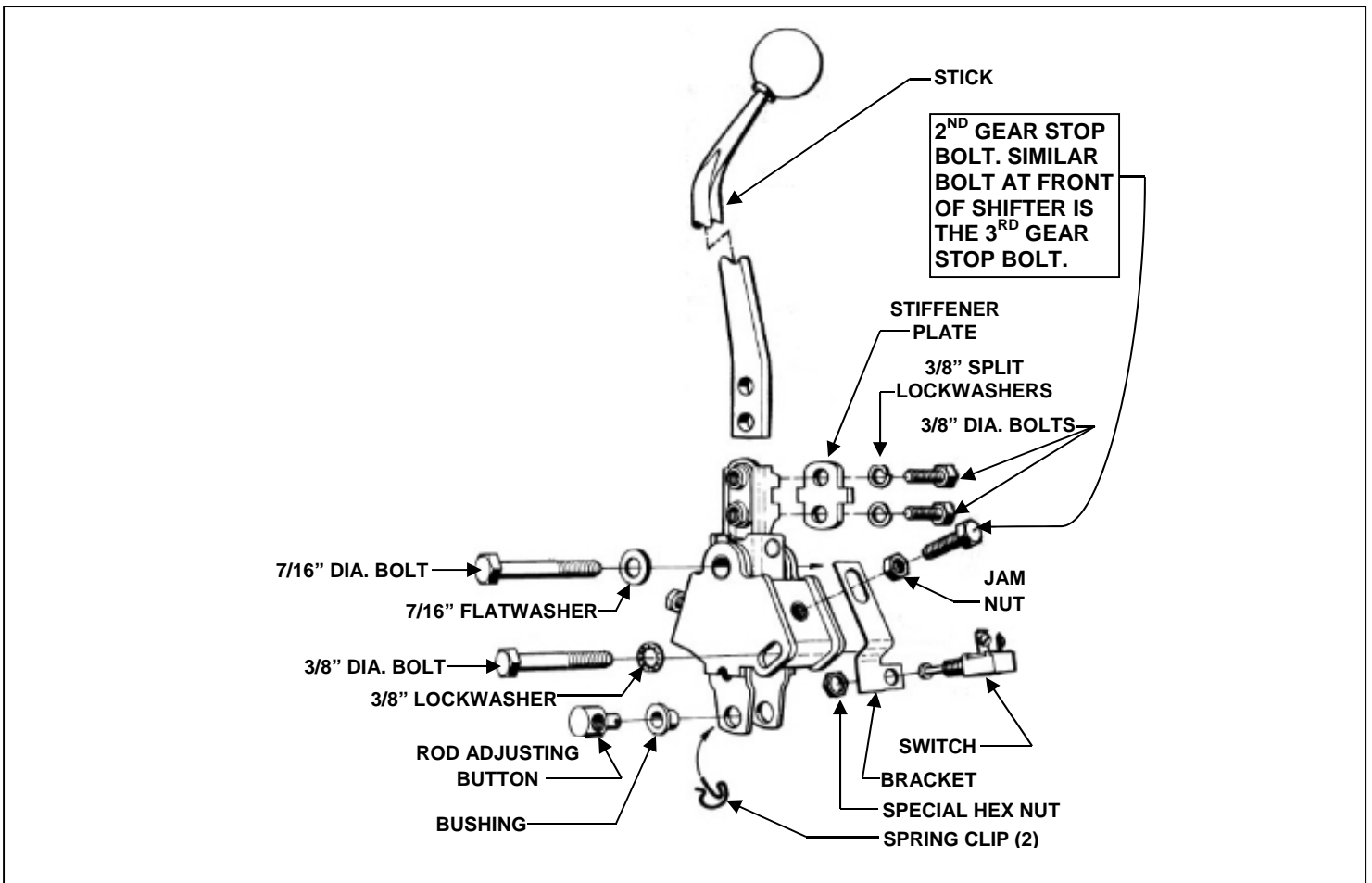

IMPORTANT: RETAIN THESE INSTRUCTIONS FOR FUTURE REFERENCE

Technical Service

A highly trained technical service department is maintained by Hurst Performance to answer your technical questions, provide additional product information and offer various recommendations.

Hurst offers a wide variety of custom T-Handles and knobs that can be used with this shifter to allow the driver to tailor the vehicle to his/hers personal liking. See your local retailer of Hurst products for specific prices.

Technical service calls, correspondence, and warranty questions should be directed to:



Hurst Performance Products

(707) 544-4761

www.Hurst-Shifters.com