



Installation Instructions

For Part Numbers:

510-340 700-461 Airaid Oiled Media Filter

511-340 701-461 SynthaMax Dry Media Filter - Red

2007-2017 Toyota Tundra

2008-2017 Toyota Sequoia

5.7L V8

2010-2013 Toyota Tundra/Sequoia

4.6L V8

Component Identification

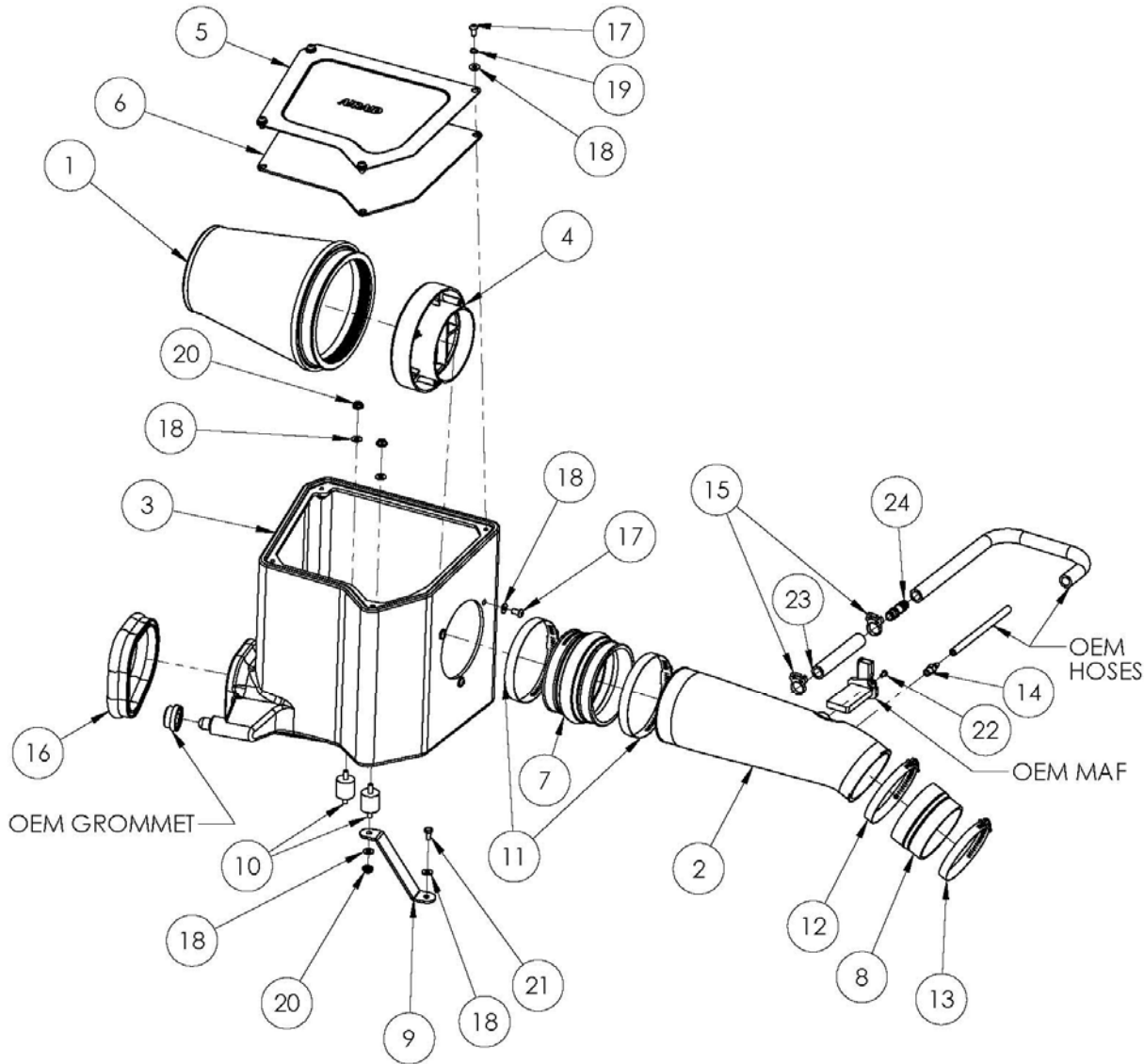

1 700/701-461	Airaid Filter	1
2 KIT213T	Intake Tube	1
3 KIT340CAB	Airbox	1
4 KITMAFADA01	Filter Adapter	1
5 KIT340LID LID	Airbox Lid	1
6 KIT340G	Lid Gasket	1
7 KITHUMPHS05EPDM	Hump Hose	1
8 KITRDCR04	Reducer	1
9 KIT110FB BRACKET	Bracket	1
10 KIT307MOUNT	Airbox Mount	2
11 KITHS68 CLAMP	#68 Hose Clamp	2
12 08620	#56 Hose Clamp	1
13 08610	#52 Hose Clamp	1
14 KITFITTING14	NPT Barbed Fitting	1
15 KITSNP16M4	Speed Clamp	2
16 102469	Edge Trim	1
17 KIT15DHC3050	Button Head Screw	7
18 KIT09FWZ019	Flat Washer	11
19 08198 WASHER	Lock Washer	4
20 KIT20WFCZ060	6mm Flange Nut	3
21 KIT60C120HCS	M6-1 x 12mm Hex Bolt	1
22 KIT15BHC3038	8-32 Button Head Screw	2
23 08485	Breather Hose	1
24 08686	1/2" Barbed Fitting	1
25 KIT110T	Cable Tie	1

NOT LEGAL FOR SALE OR USE ON ANY POLLUTION CONTROLLED MOTOR VEHICLE IN CALIFORNIA OR STATES ADOPTING CALIFORNIA EMISSION PROCEDURES.

See AIRAID.COM for CARB status on each part for a specific vehicle.

Full color instructions can be viewed on our web site at Airaid.com. If you need any assistance please call 1-800-858-3333 to speak with a representative in our Customer Service Center before returning the product.

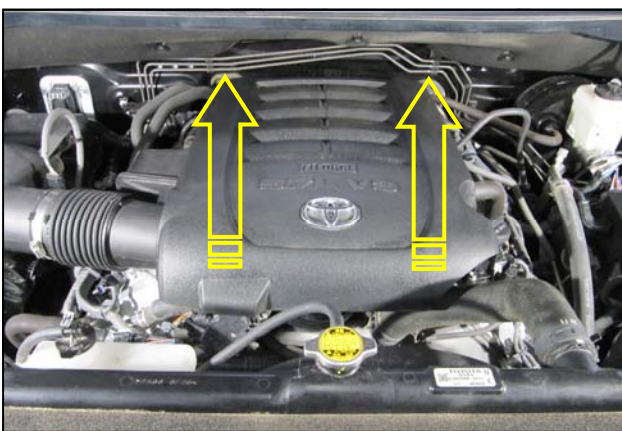

1. Disconnect the Negative battery Terminal. Remove the engine cover and set it aside.

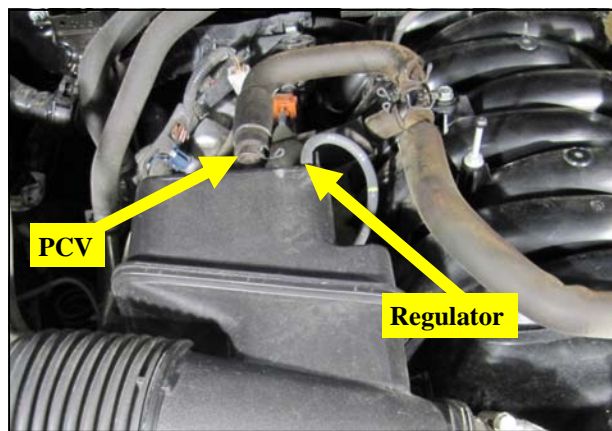

2. Disconnect the PCV and fuel pressure regulator lines from the resonator chamber on the factory intake tube.

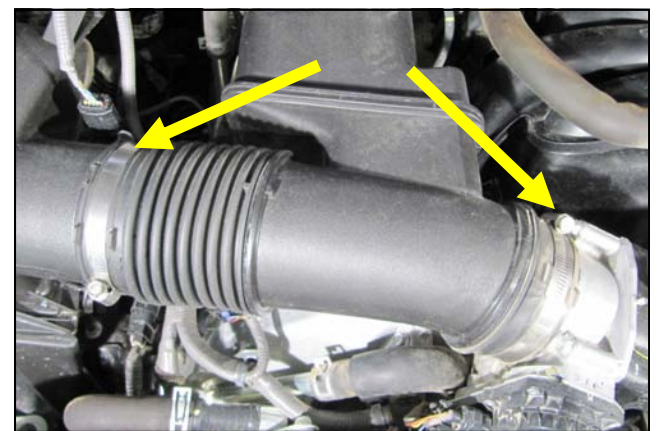

3. Loosen the clamps on the intake tube and remove it from the vehicle.

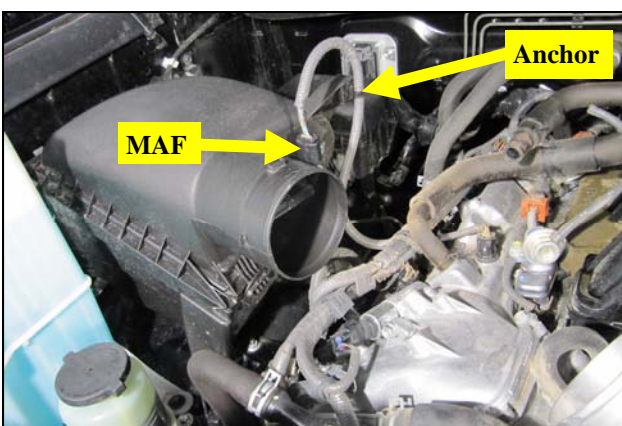

4. Gently separate the wire harness anchor from the airbox and disconnect the Mass Air Flow meter or MAF.

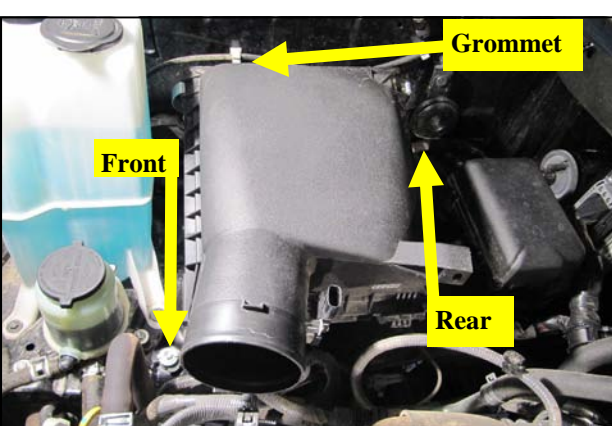

5. Loosen the Front and Rear captive bolts in the airbox base and remove the entire air box assembly. Ensure that the airbox mounting grommet remains on the airbox and not in the inner fender.

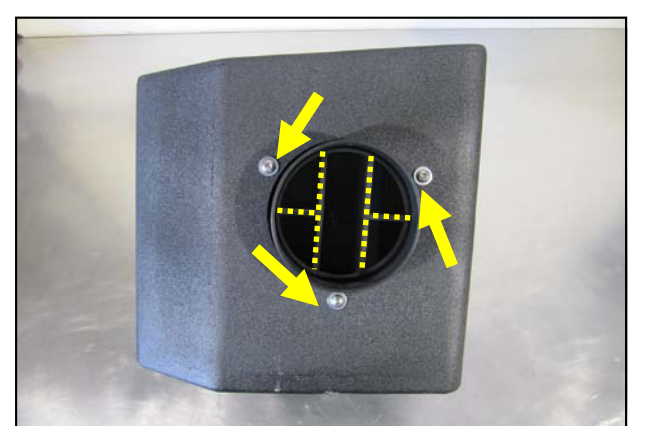

6. Install the Filter Adapter onto the Airbox using three sets of 1/4-20 Button Head Screws and Flat Washers. Note the positioning of the Adapter in the Airbox. When properly installed, the long air vanes are vertical and the short vanes are horizontal.

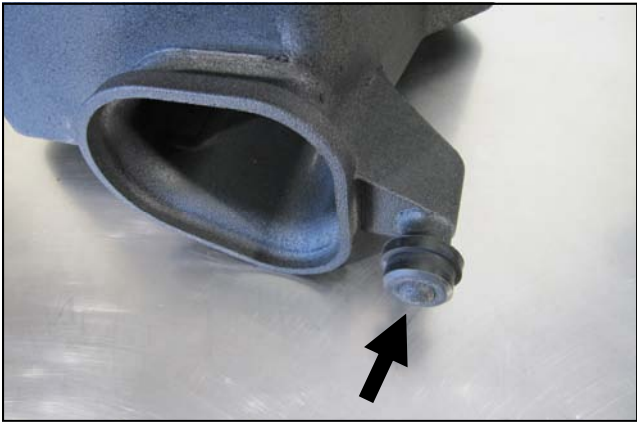

7. Transfer the OEM airbox grommet onto the Airaid airbox as shown.



8. Install the Edge Trim onto the Airaid airbox inlet. Trim excess if necessary. **Hint:** Relaxing the crimp on the Edge Trim with screwdriver or similar will ease the installation.

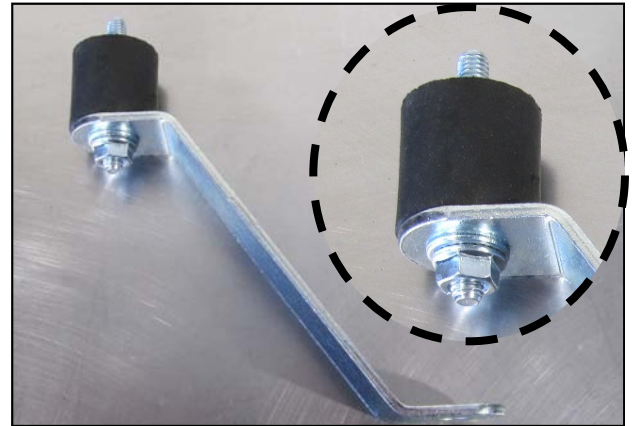

9. Using a 6mm Flange Nut and Flat Washer, install the Airbox Mount onto either side of the Bracket.

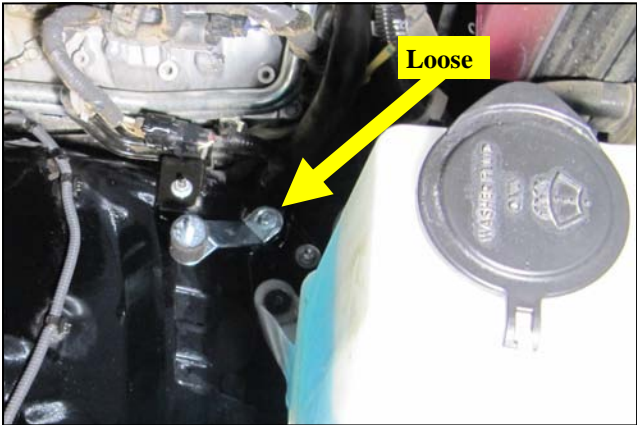

10. Using the 6mm Hex Head Bolt and one Flat Washer, loosely install the Bracket and mount assembly to the Front airbox bolt hole from step 4.

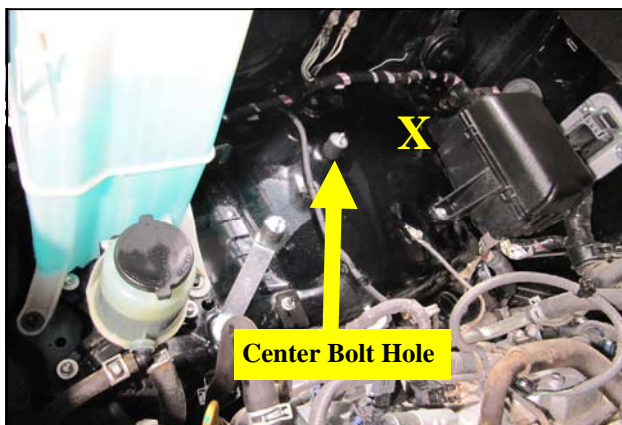

11. Install the second Airbox mount, hand tight, into the center threaded bolt hole in the inner fender— Not in the Rear bolt hole from step 4.

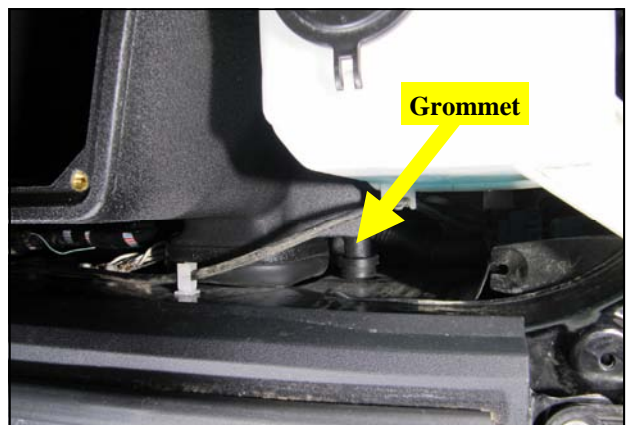

12. Lower the Airaid Airbox into the engine compartment and gently insert the Airbox grommet into the fender hole.

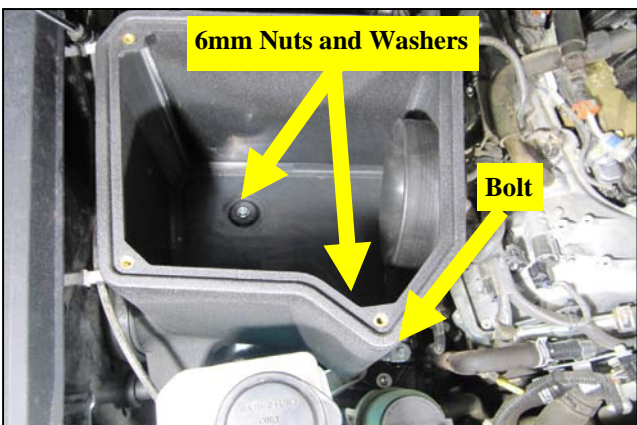

13. Carefully align the holes in the Airbox floor with the posts of the Mounts and secure using the remaining two 6mm Flange nuts and two Flat Washers. Make the Bracket Bolt from step 9, final tight at this time.



14. Insert the NPT Barbed Fitting into the Airaid Intake Tube as shown.

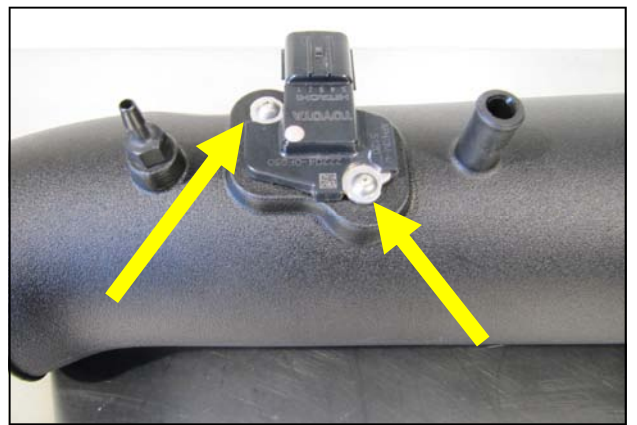

15. Transfer the Mass Air Flow sensor into the Airaid Intake tube and secure using the supplied 8-32 Screws.

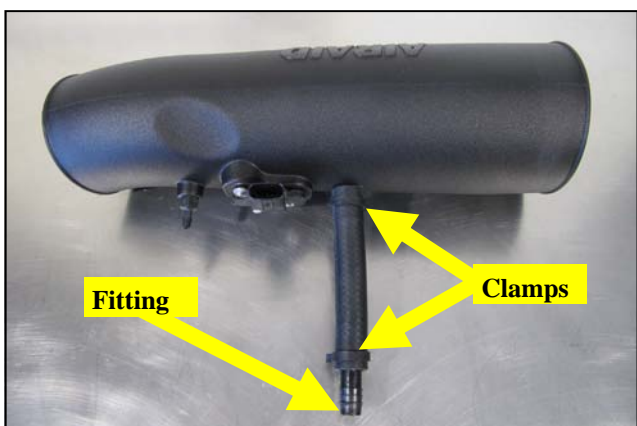

16. Slide the supplied breather hose onto the Intake and the 1/2" Barbed Fitting into the opposite end. Secure using the Speed Clamps.



17. Slide the Hump Hose with the two 68 Clamps all the way onto the Intake tube as shown.

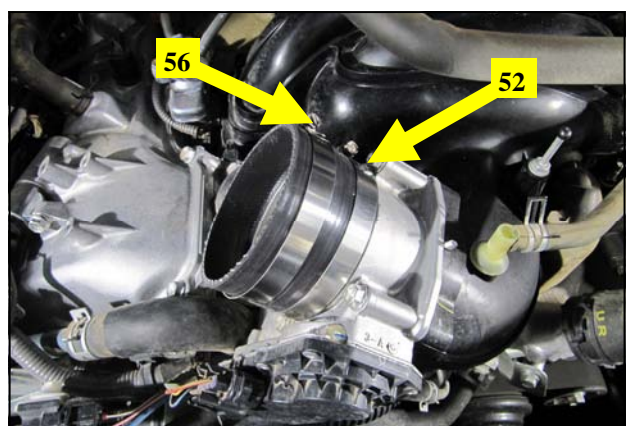

18. Slide the Reducer and the 52 and 56 Clamps onto the Throttlebody.

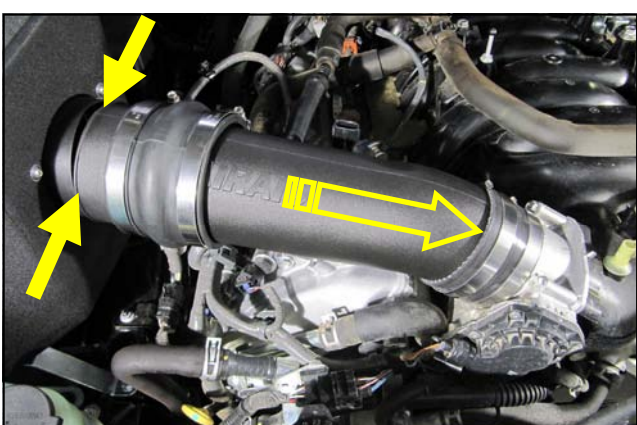

19. Insert the Intake tube into the Reducer and align Hump Hose with the Filter adapter in the Airbox.



20. Slide the Hump Hose and Clamps onto the Filter adapter and tighten all four Intake Clamps.

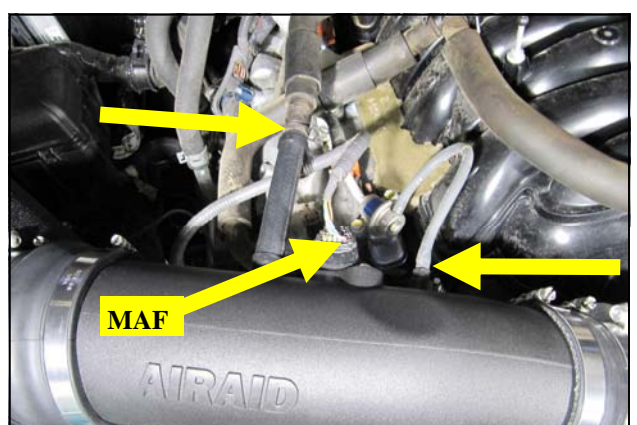

21. Reconnect the MAF and connect the PCV and fuel pressure regulator lines onto the Intake Tube.



22. Use the provided Cable Tie to secure the MAF harness to the PCV line as shown. Trim excess.



23. Install the Airaid Premium Air filter onto the Filter Adapter inside the airbox.



24. Prepare the Airbox Lid for Gasket installation by cleaning the mounting surface using a Prep Solvent or equivalent. Remove the adhesive backing from the Gasket and carefully apply it as shown with the screw holes aligned.



25. Remove the protective film from the other side of the Lid and mount it to the Airbox using 4 sets of 1/4-20 Button Heads, Lock Washers and Flat Washers.



26. Slowly lower the hood to test clearances. Make sure all clamps, hoses, bolts, and screws are tight. Double check the hood clearance. Reconnect the Negative battery terminal.

Thank you for purchasing the Airaid Intake System. Contact Airaid @ (800) 498-6951 8:00 AM - 5:00 PM MST weekdays for questions regarding fit or instructions that are not clear to you. Your Airaid Intake System was carefully inspected and packaged. Check that no parts are missing, or were damaged during shipping. If any parts are missing, contact Airaid. The air filter element is protected from direct exposure to water and debris; care should be taken not to drive through deep water. WATER INGESTION IS THE DRIVERS RESPONSIBILITY! The air filter is reusable and should be cleaned periodically.

FILTER IDENTIFICATION

700-461 Airaid Oiled Media

701-461 Airaid SynthaMax Dry Media - Red

For your Oiled media filter we suggest using the AIRAID Filter Tune-Up Kit!



P/N 790-551 Aerosol Spray
P/N 790-550 Squeeze Spray



NOT LEGAL FOR SALE OR USE ON ANY POLLUTION CONTROLLED MOTOR VEHICLE IN CALIFORNIA OR STATES ADOPTING CALIFORNIA EMISSION PROCEDURES.

See AIRAID.COM for CARB status on each part for a specific vehicle.



Do Not Oil

Synthamax Air Filters do not require oil. Service air filter as needed by cleaning with common non-petroleum all-purpose household cleaner and water. Simple Green®, Formula 409® or equivalent works great. Apply cleaner to outside of air filter and allow to soak. Then flush filter clean from the inside out with a garden hose and repeat steps if necessary. Do not apply high pressure water or air to clean filter. Allow filter to air dry and reinstall.

AIR-151340A
REV.02.14.17

This page intentionally left blank