



STEEDA

Tri-Ax Shifter

For: 2013+ Ford Focus ST

Installation Instructions For Kit #555-7241

- This shifter **DOES** require permanent modifications to the center console
- This shifter is rather difficult to replace due to tight fitment. If you are not familiar with Ford FWD car shifters, a qualified technician should be used.

Removal of the Factory Shifter

1. Place the car on a level surface with the transmission in neutral and engage the parking brake.
2. Gently lift up/tug on the trim bezel around the shifter boot. There are four clips to unclip, two on the left, and two on the right. This is easiest to do by gripping the bezel through the boot. You may want to shift/reposition the boot when doing the left and right sides. See figure 1 for location of the clips.
3. Unscrew the shifter knob. Lift the boot, reverse lockout mechanism, and trim bezel off the shifter and set aside.

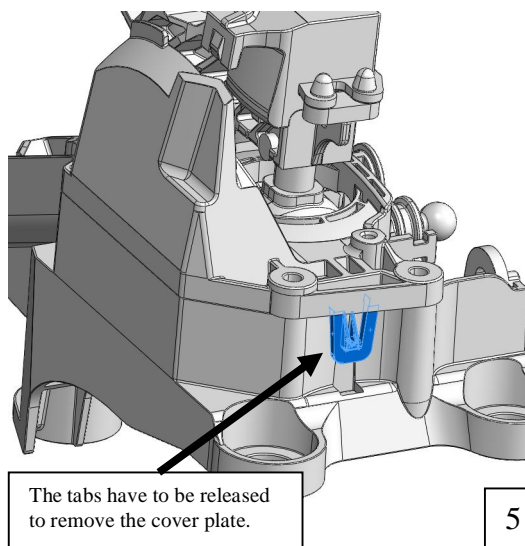
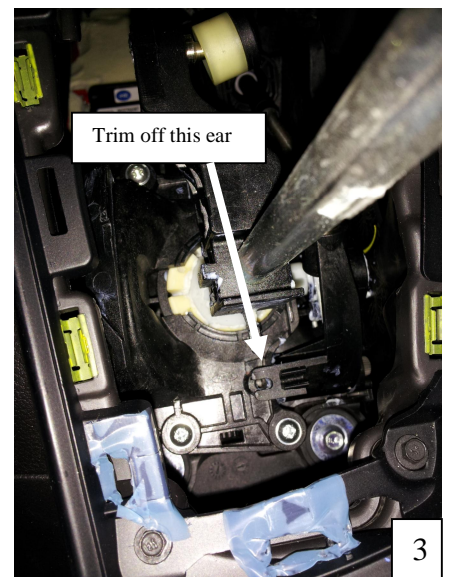
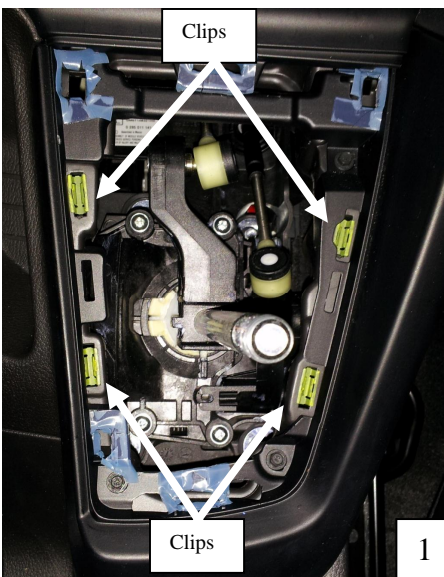

4. Gently pry the shifter cable sockets off both ball studs on the shifter. This can be done with a small prying tool, or a large flat tip screwdriver between the shifter and the socket. See figure 2.
5. Carefully trim the assembly locking ear on the shifter base with a pair of sharp side-cut pliers, or similar tool. See figure 3. Enough of the ear must be removed so that the cover plate below it can be unclipped and lifted off. The ear is used solely for locking the shifter in place during shipping. See figure 4.
6. Remove the four Phillips head screws on each corner of the cover plate, securing the shifter cover plate to the base. See figure 3.
7. Carefully unclip the two plastic ears securing the cover plate to the shifter base. They are located in the front and rear of the top plate. See figure 5. The cover plate should be loose now.
8. Unload the torsion spring on the side of the shifter (see figure 6) with a pair of needle nose pliers, Vice Grip pliers work best. It is most convenient to rest the spring's top leg on the side arm of the shifter.
9. Carefully pull up on the shifter lever and maneuver the assembly (with top plate) out of the base.

Disassembly of the Factory Shifter

10. **Carefully** pry off the small plastic socket from the end of the shifter arm. See figure 7.
11. **Carefully** remove the clear rubber O-Ring from the arm of the shifter. See figure 7.
12. **Carefully** pry off the large plastic socket from the main lever. See figure 7.
13. Slip the cover plate off the factory shifter.

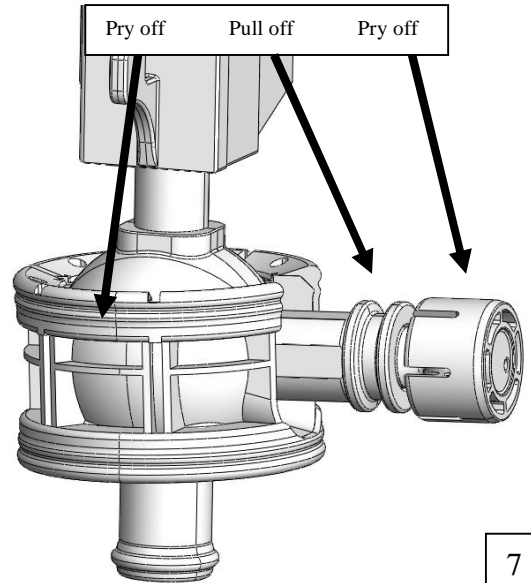

Assembly of the Steeda Tri-Ax Shifter

14. Transfer the cover plate from the factory shifter over the Tri-Ax shifter.
15. Transfer the clear O-Ring onto the Tri-Ax shifter side arm. It is to be located in the same position and orientation as the factory shifter.
16. Transfer any remaining grease on the factory shifter to the similar parts on the Tri-Ax shifter. Adding additional Lithium grease may be desired.
17. **Carefully** transfer both plastic sockets onto the Tri-Ax shifter.
18. Thread the provided ball stud to the shifter arm as seen in the figures below. A small amount of blue Loctite is highly recommended. See the adjustment note.

****Adjustment Note:**

- The top threaded hole in the shifter arm provides the most throw reduction; the bottom hole provides the least. The three figures illustrate how to properly assemble the shifter based on your desired amount of throw reduction.

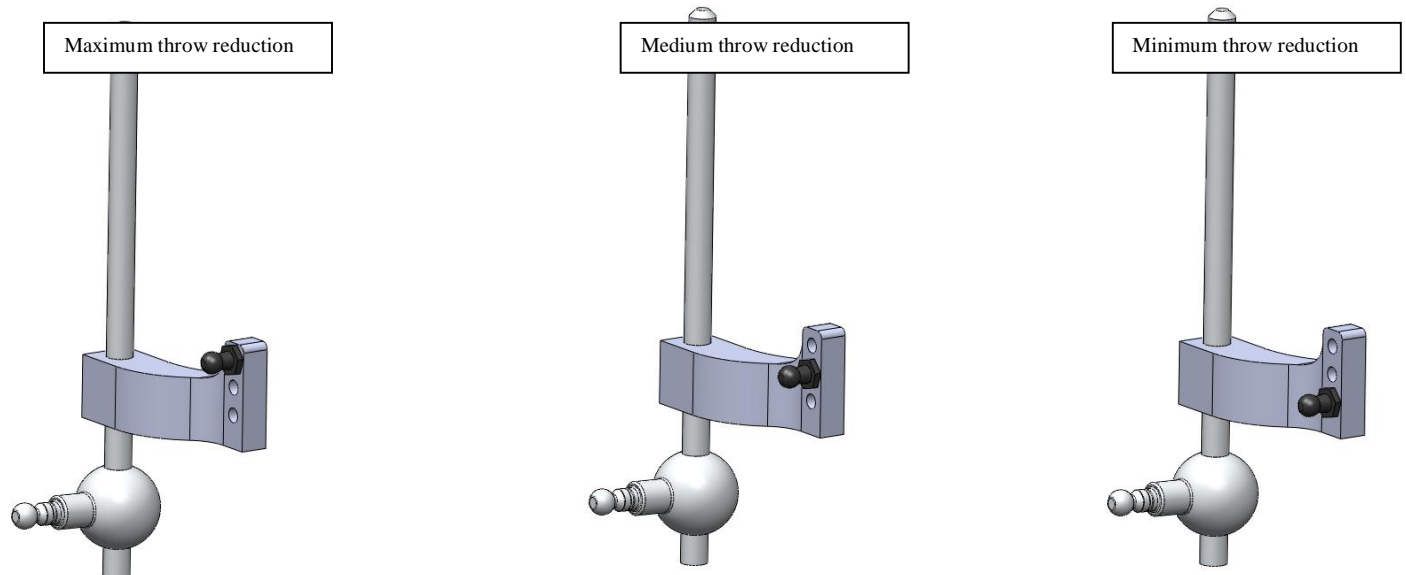

Center Console Modification

- You will have to trim two or three parts in the center console to gain the necessary clearance for the shifter to function.
 - To trim the console, follow the steps below.
 - CAREFULLY cut the center strip between the front clips of the shifter bezel as shown in figures 8 and 9. A Dremel tool, or sharp cutting pliers are recommended. This will **NOT** affect how the shifter bezel fits or appears later.
 - CAREFULLY trim off the edge of the black base as seen in figure 10. Again, a Dremel tool, or sharp cutting pliers are recommended. This will have no noticeable effect on the rigidity of the center console.
 - If using the middle or max throw reduction the shifter may not return to the 1-6 gates without having to lift up on the reverse lock-out collar. If this occurs, you can CAREFULLY sand/grind down the small ear on the reverse lockout mechanism shown in figure 11.

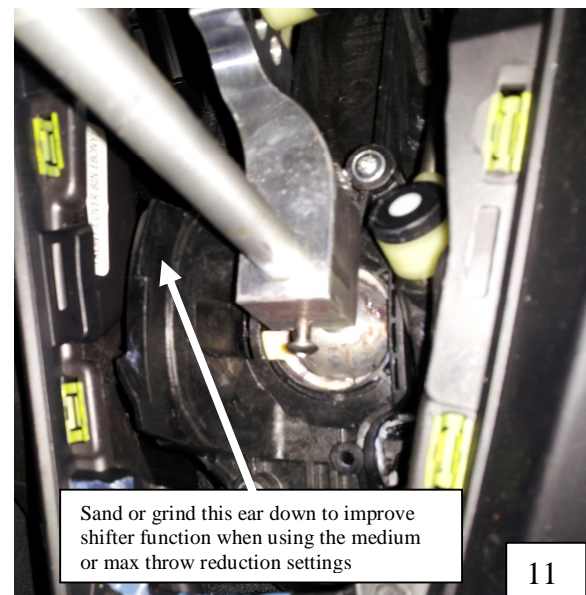
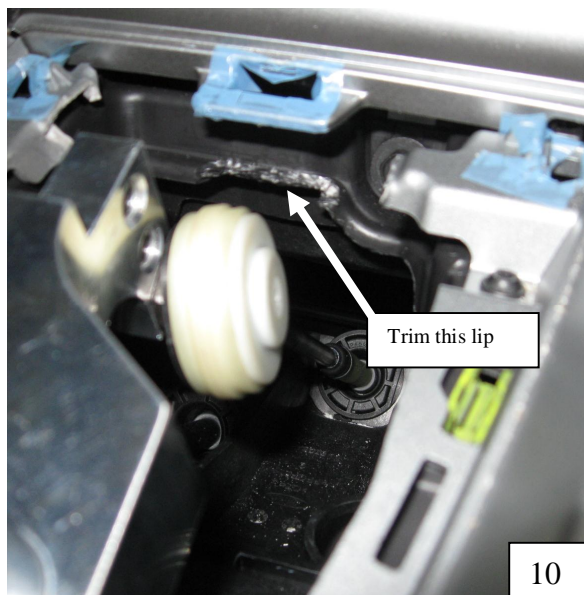
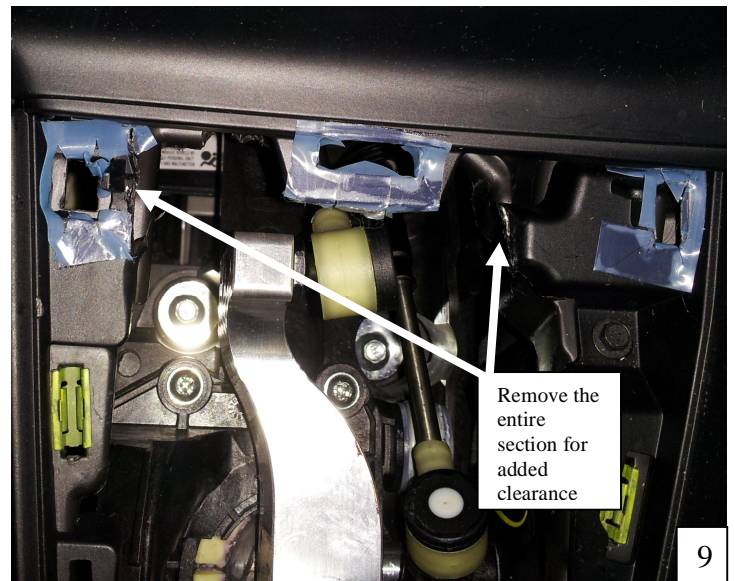

Installation of the Steeda Tri-Ax Shifter

19. Install the Tri-Ax shifter assembly in the same location and orientation as the factory shifter.
20. Complete installation in reverse order of removal. **Note:** prior to reinstalling the shifter bezel and knob, shift the transmission through all gears to ensure there is no binding or rubbing with any parts in the center console/shifter assembly. Any rubbing will require additional trimming to the console components and should be performed in small increments.
21. You are done. Test drive the car to verify shifter function.

Thank you for choosing Steeda Autosports! If you have any questions or comments please call us at 954-960-0774 or email GoFast@Steeda.com