

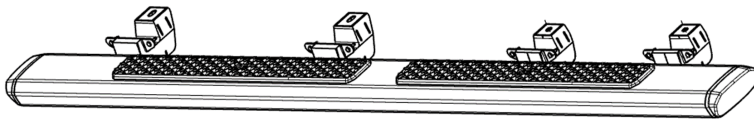

Jeep Truck

Tube Step - 4 Door



A LH

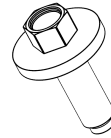

C 8x

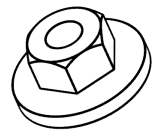

D 16x

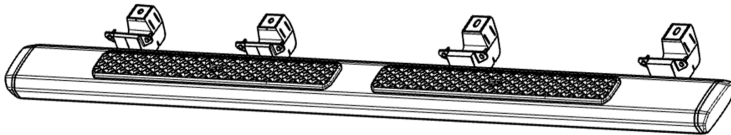

B RH

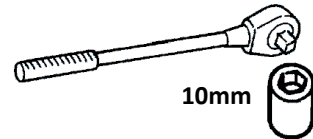

10mm

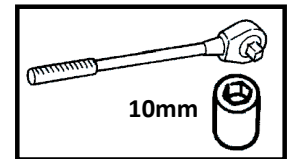
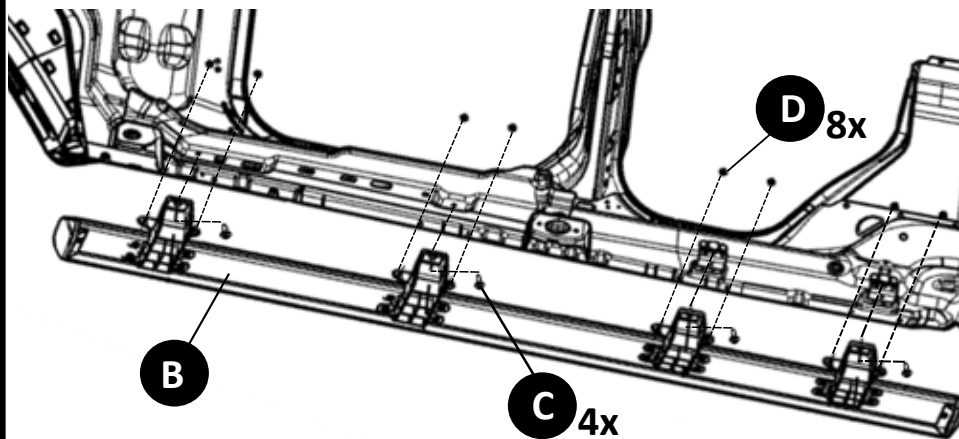

10mm

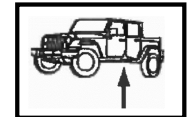

C 27.5 ± 2.8 Nm

D 13.0 ± 1.3 Nm

Note: Repeat for other side