



Installation Instructions

For Part Numbers:

510-309 700-462 Airaid Oiled Media Filter

511-309 701-462 SynthaMax Dry Media Filter - Red

2016-17 Toyota Tacoma 3.5l V6

NOT LEGAL FOR SALE OR USE ON ANY POLLUTION CONTROLLED MOTOR VEHICLE IN CALIFORNIA OR STATES ADOPTING CALIFORNIA EMISSION PROCEDURES.

See AIRAID.COM for CARB status on each part for a specific vehicle.

Component Identification

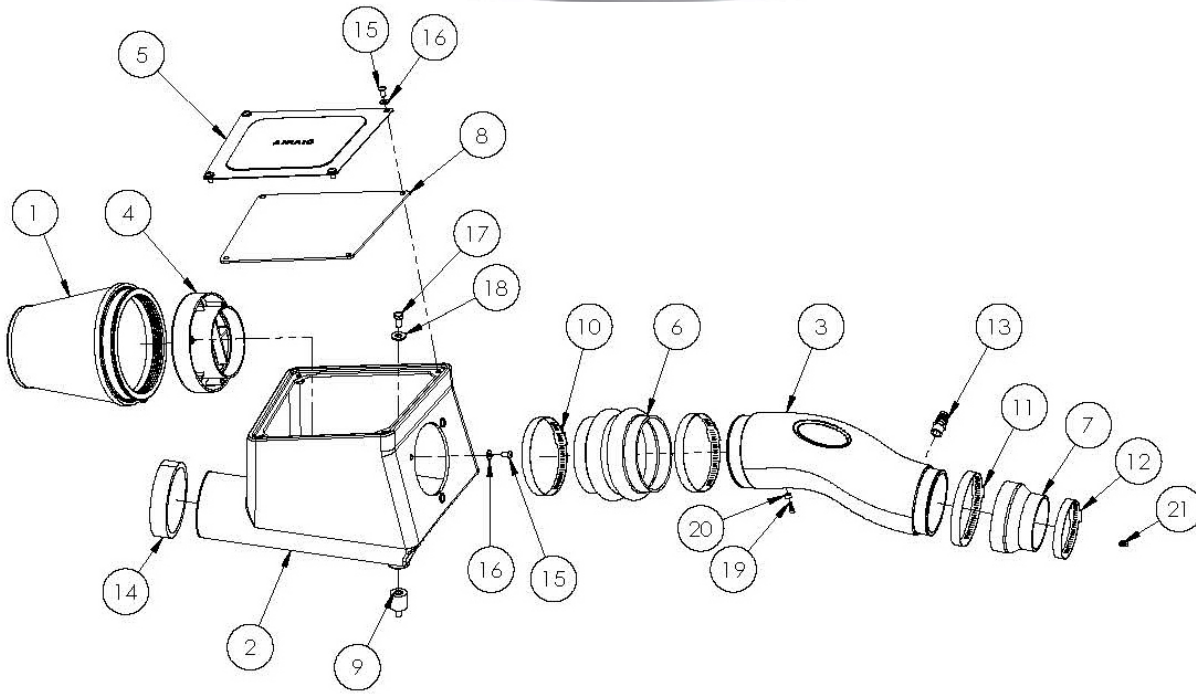

1	700-462/701-462	Air Filter	1
2	KIT301CAB	Airbox	1
3	KIT309	Intake Tube	1
4	KITMAFADA01	Filter Adapter	1
5	KIT301LID	Airbox Lid	1
6	KITHUMPHS33	Hump Hose	1
7	KITRDCR22	Coupler	1
8	KIT301G	Lid Gasket	1
9	KIT301MOUNT	CAB Mount	3
10	KITHS68	68 Clamp	2
11	KITHS64	64 Clamp	1
12	08601	48 Clamp	1
13	KITFITTING30	Barbed Fitting	1
14	KITWSTRIP06	Weatherstrip	1
15	KIT15DHC3050	1/4-20 Button Head Screw	7
16	KIT09FWZ019	1/4" Flat Washer	7
17	KIT20CSCZ160	8mm Hex Head Cap Screw	3
18	KIT31NWUSPZ	5/16" Flat Washer	3
19	KIT10SHCP	#8 Socket Head Screw	2
20	KITSPACER01	Nylon Spacer	2
21	KITSPACER07	Aluminum Spacer	1
22	KIT110T	Zip Tie	1
23	KITSTICKER12	Airaid Badge	1

Full color instructions can be viewed on our web site at Airaid.com. If you need any assistance please call 1-800-838-3333 to speak with a representative in our Customer Service Center before returning the product.

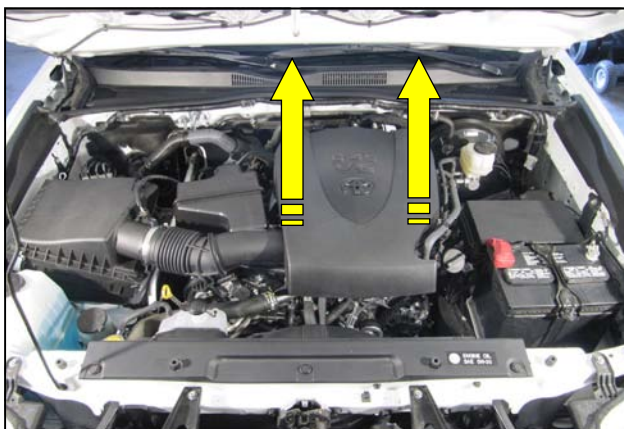

1. Disconnect The Negative Battery Terminal. Remove the engine cover. Lift up on the front of the engine cover to unseat the mounting grommets and remove it from the vehicle.

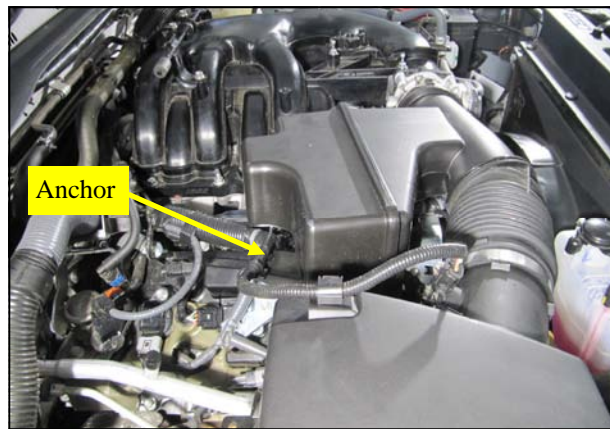

2. Pry the wire harness anchor from the tab on the resonator.

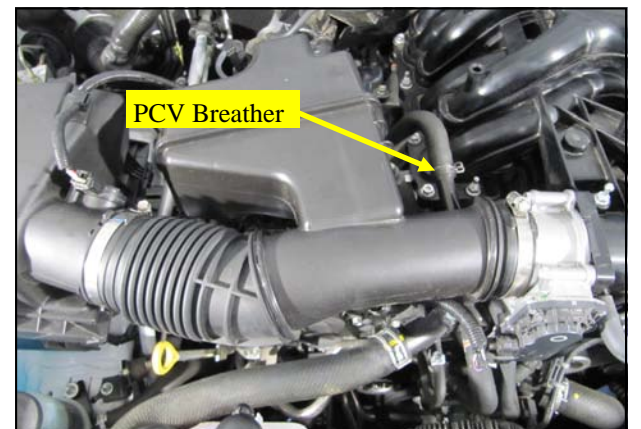

3. Disconnect the PCV breather line. Loosen the clamps on both ends of the intake tube and remove the entire intake/resonator assembly from the vehicle.

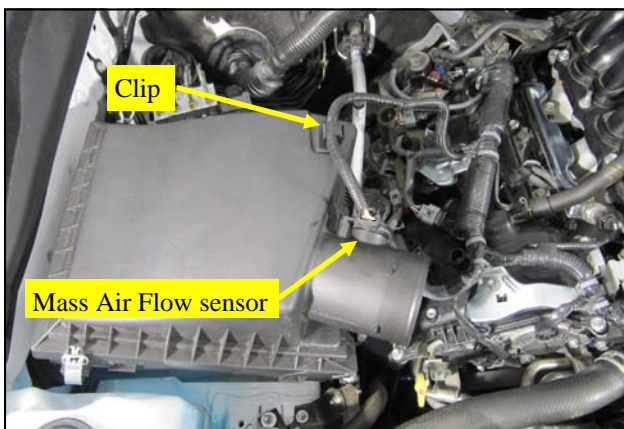

4. Disconnect the Mass Air Flow sensor, or MAF and unclip the harness on the air box top. Remove the factory airbox top and air filter.

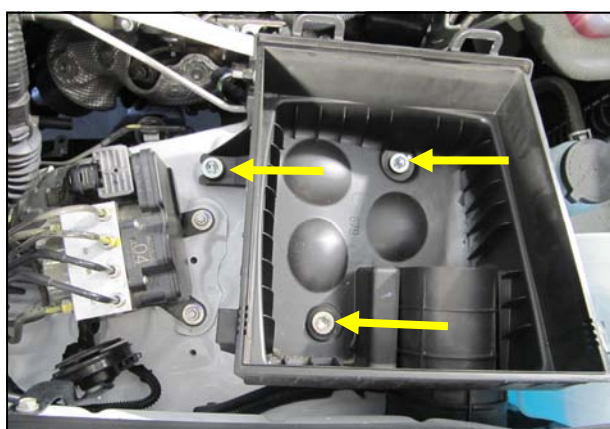

5. Remove the three anchor bolts in the lower half of the airbox and remove it from the vehicle.

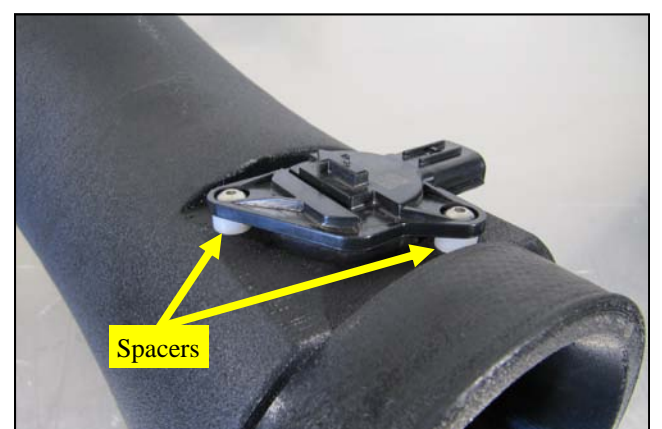

6. Transfer the Mass Air Flow sensor from the factory airbox, into the Airaid Intake tube and secure using the two Spacers and #8 Socket Head screws. **Do not use the factory screws.**



7. Install the Barbed fitting into the Airaid Intake Tube as shown. Apply the Airaid Badge to the Intake Tube as shown.

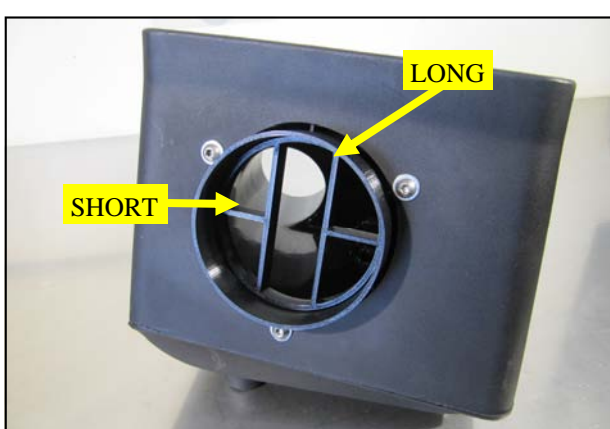

8. Install the Filter Adapter onto the Airbox using three sets of 1/4-20 Button Head Screws and Flat Washers. Note the positioning of the Adapter in the Airbox. When properly installed, the long air vanes are vertical and the short vanes are horizontal.



9. Prepare the Airbox inlet for Weatherstrip installation by cleaning the surface using a Prep Solvent or equivalent. Apply the self adhesive, Foam Weatherstrip onto the air inlet on the Air Box as shown. Trim any excess.



10. Prepare the Airbox Lid for Gasket installation by cleaning the mounting surface using a Prep Solvent or equivalent. Remove the adhesive backing from the Gasket and carefully apply it as shown with the screw holes aligned.

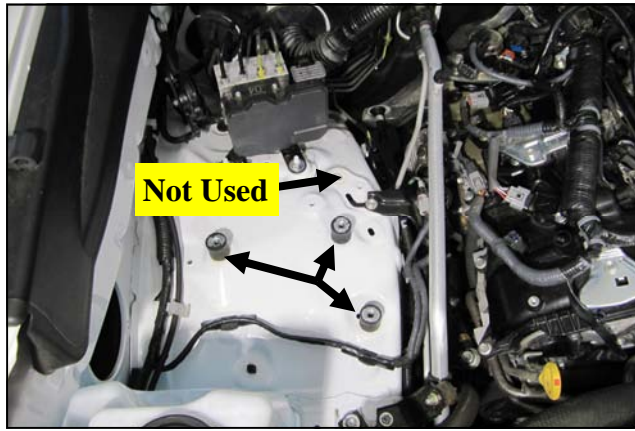

11. Install the three CAB Mounts, hand tight, into the weld nuts on the inner fender as shown. Note: One of the original air box mounting holes is not re used.



12. Position the Airaid Airbox assembly into the engine compartment as shown.

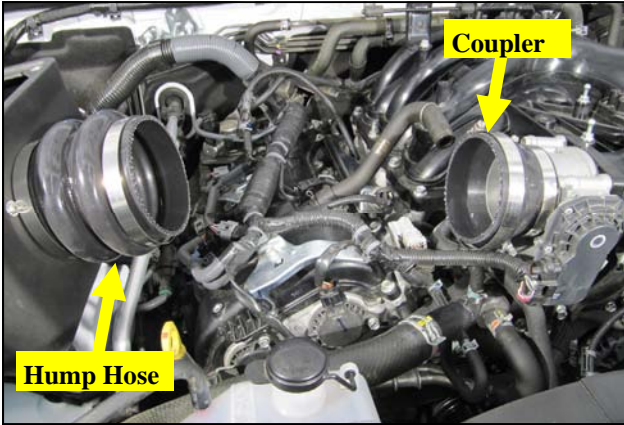

13. Slide the Hump Hose and two #68 Hose Clamps onto the Filter Adapter as shown. Slide the Coupler and the #48 and #64 Clamps on to the throttlebody. Leave the Clamps loose for now.



14. Insert the Intake tube into the Hump Hose and coupler. Align the tube with the PCV line, re connect it and tighten all 4 Clamps.

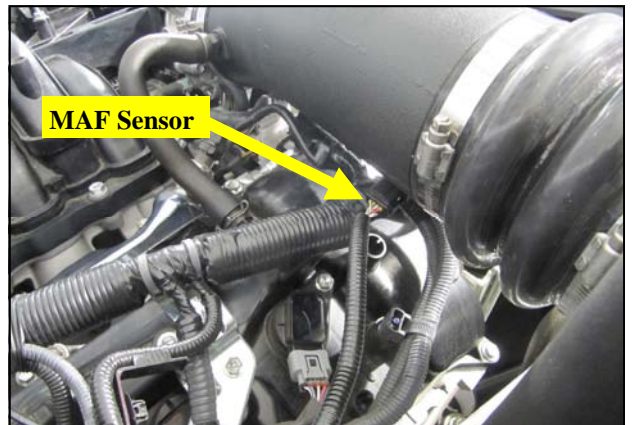

15. Reconnect the Mass Air Flow sensor, now located on the bottom of the Intake Tube.

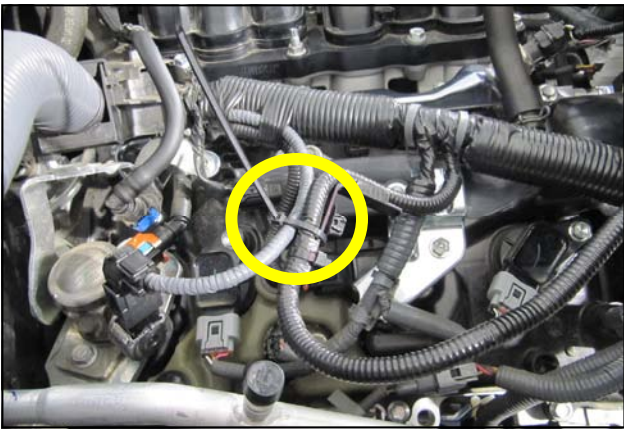

16. Use the supplied Zip Tie to tether the MAF harness to an adjacent sub harness as shown. Trim the excess length when finished.



17. Mount the Airaid Airbox onto the CAB Mounts using the three 8mm Bolts and 5/16 Flat Washers



18. Install the Airaid Premium Filter onto the Filter Adapter.

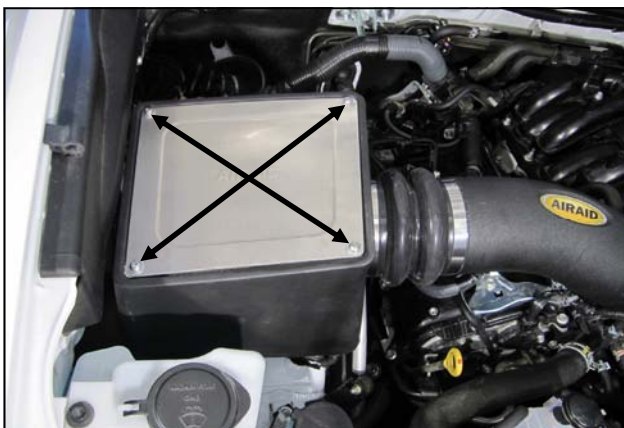

19. Remove the protective film from the other side of the Lid and mount the Lid onto Air Box using four 1/4-20 x 1/2" Button Head Bolts , and 1/4" Flat Washers .



20. Remove the front engine cover mounting post and place the Aluminum Spacer onto the threaded stud like a washer and re tighten.

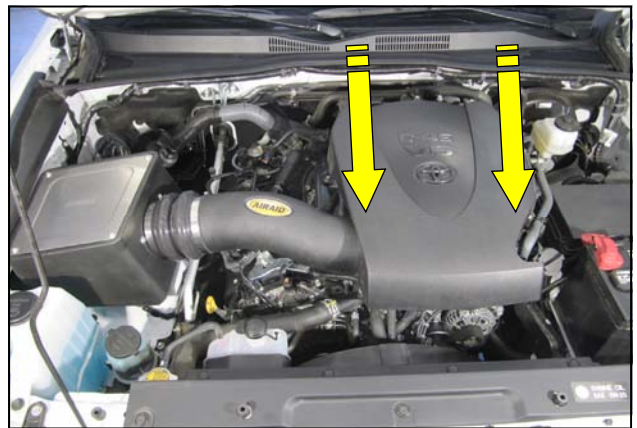

21. Reinstall the engine cover. Slowly lower the hood to test clearances. Make sure all clamps, hoses, bolts, and screws are tight. Double check the hood clearance. Reconnect the negative battery terminal.

Thank you for purchasing the Airaid Intake System. Contact Airaid @ (800) 498-6951 8:00 AM - 5:00 PM MST weekdays for questions regarding fit or instructions that are not clear to you. Your Airaid Intake System was carefully inspected and packaged. Check that no parts are missing, or were damaged during shipping. If any parts are missing, contact Airaid. The air filter element is protected from direct exposure to water and debris; care should be taken not to drive through deep water. WATER INGESTION IS THE DRIVERS RESPONSIBILITY! The air filter is reusable and should be cleaned periodically.

For your Oiled media filter we suggest using the AIRAID Filter Tune-Up Kit.
P/N 790-551 Aerosol Spray
P/N 790-550 Squeeze Spray

Synthamax Air Filters do not require oil. Service air filter as needed by cleaning with common non-petroleum all-purpose household cleaner and water. Simple Green®, Formula 409® or equivalent works great. Apply cleaner to outside of air filter and allow to soak. Then flush filter clean from the inside out with a garden hose and repeat steps if necessary. Do not apply high pressure water or air to clean filter. Allow filter to air



NOT LEGAL FOR SALE OR USE ON ANY POLLUTION CONTROLLED MOTOR VEHICLE IN CALIFORNIA OR STATES ADOPTING CALIFORNIA EMISSION PROCEDURES.

See AIRAID.COM for CARB status on each part for a specific vehicle.