



WARNING

Proper operation of your brakes is essential for your safety and the safety of others. Any brake service should be performed ONLY by persons experienced in the installation and proper operation of brake systems. It is the responsibility of the person installing any brake component or kit to determine the suitability of the component or kit for the particular application. After installation and before operating your vehicle, be sure to test the function of the brakes under controlled conditions.

DO NOT DRIVE WITH UNTESTED BRAKES!

FOR TECHNICAL ASSISTANCE CALL:

888-533-1199

MONDAY - FRIDAY

8:00 AM TO 5:00 PM EST

IMPORTANT

Take time to read all the literature that came with this kit. Check the provided list of parts against what you received to ensure all parts are present. While this kit was designed to make the process of changing brake parts as simple as possible. **NOTE: WITH SOME KITS IT MAY BE NECESSARY TO MAKE MINOR CHANGES TO YOUR CAR!**

READ ALL WARRANTY DISCLAIMERS AND RETURN POLICIES INCLUDED IN THIS KIT PRIOR TO INSTALLATION!

MASTER POWER BRAKES

110 CROSSLAKE PARK RD. MOORESVILLE, N.C. 28117

www.mpbrakes.com



BM1528

1971-1973 MUSTANG BOOSTER WITH MASTER CYLINDER

IT S MORE THAN BRAKES...IT S CONFIDENCE!

INSTALLATION INSTRUCTIONS



MASTER POWER BRAKES

110 CROSSLAKE PARK RD MOORESVILLE N.C. 28117

www.mpbrakes.com 704-664-8866



REVISED 111202

INSTALLATION INSTRUCTIONS

INCLUDED COMPONENTS

Your power brake conversion kit will contain the following components:

1. 9" power booster with linkage to pedal
2. Master cylinder
3. Intake manifold fitting
4. 11/32 vacuum hose (18") with manifold fitting
5. Replacement pedal pin with nut
6. Bench bleeding kit (not shown)

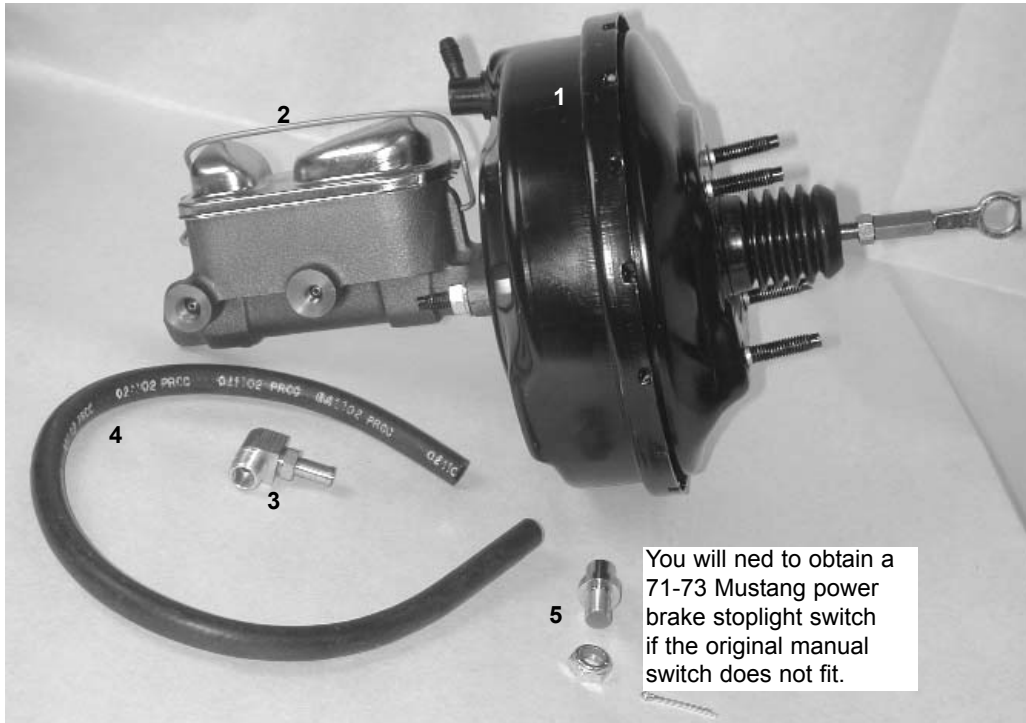

INSTALLATION

1. Disconnect the brake lines from the original master and remove the cylinder from the firewall.
2. Remove the manual brake firewall plate that's under the master.

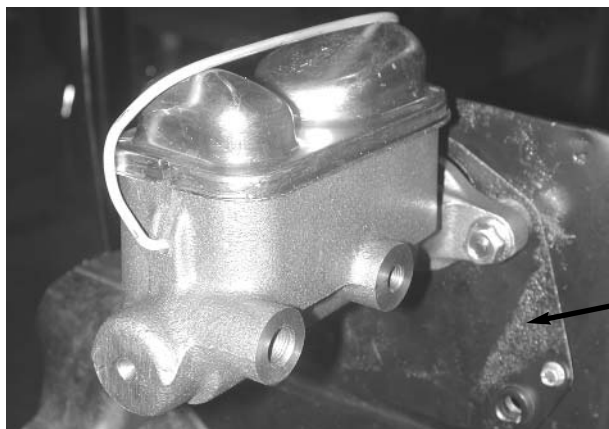

3. Remove the two studs that held the original master to the firewall.

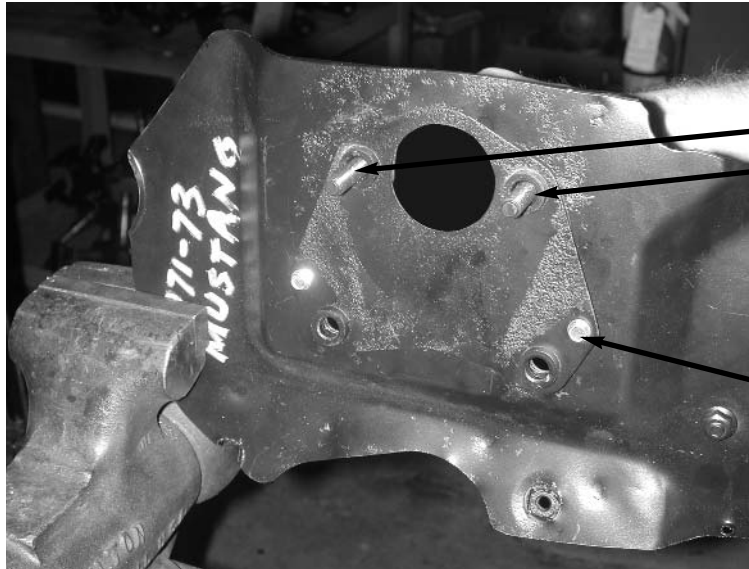

Remove these two studs

Remove the screws to remove the plate

4. After removing the plate and the master cylinder studs you must drill out the firewall stud holes to 7/16". From under the dash drill out the four bolts that hold the hanging pedal to the firewall. While the hanging pedal bracket is out it's easier to remove the pedal and drill a hole for installation of the new pin. If you choose you may remove the pedal after the booster is mounted. See step 5 for new hole drilling instructions. Insert the four booster studs into these holes, through the hanging pedal assembly and tighten with correct nuts.

The four booster studs go through these holes and secure the hanging pedal from inside the car

These holes must be drilled to 7/16"

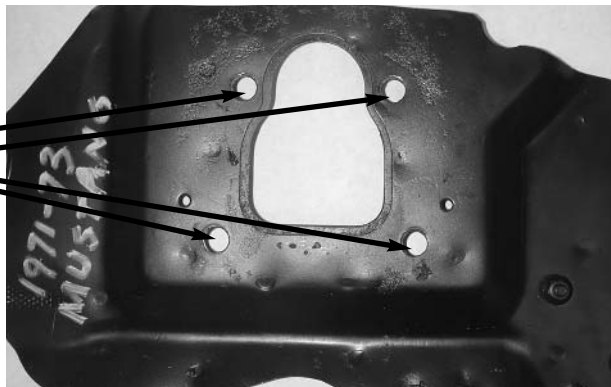

Booster studs through the firewall and securing the hanging pedal bracket from inside the car

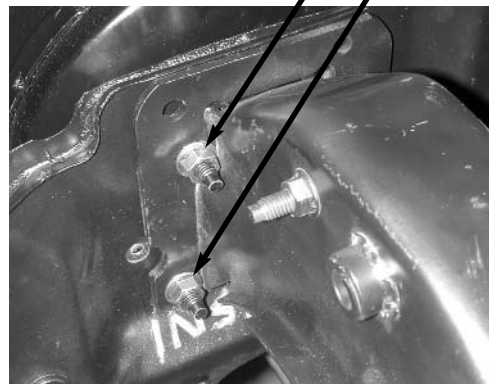

5. You must remove the brake pedal to drill a new hole for push rod attachment. A power brake system will not work correctly with the rod attached to the original manual brake pin since power brakes require less leverage. Attachment to the original pin will make the brakes too sensitive. Remove the bolt that the pedal pivots on and take out the pedal.

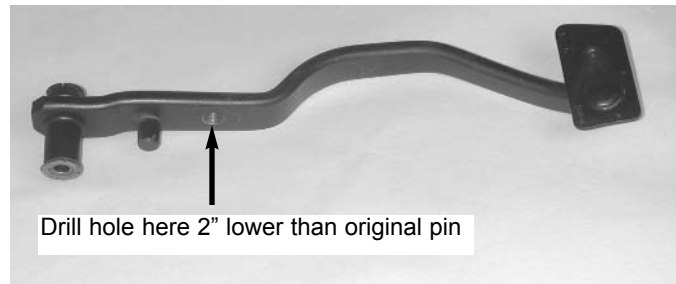

Drill a 1/2" hole in the pedal 2" lower than the original pin and insert the new supplied pin. Secure with supplied nut.

Re install the pedal into the hanging bracket and secure. Do not over tighten. the pedal must pivot freely.

6. Now you are ready to attach the booster rod to the new pedal pin but before doing so you must re attach the brake light switch as shown. Secure the rod and switch to the pedal with the cotter pin.



7. The brake pedal should be adjusted so there's about 1/4-1/2" free travel in the pedal before the booster rod moves.

8. Bench bleed the master before installing to remove all air. Be sure to use a good quality DOT 3 or DOT 4 fluid. **USE OF SILICONE BRAKE WILL VOID WARRANTY.**

9. Mount the master to the booster and re attach the brake lines.

10. Supply the booster with at least 18" of vacuum from either the back of the carburetor or the intake manifold. A fitting for pulling vacuum from the intake manifold is supplied.

11. Bleed the entire brake system and test drive before using.

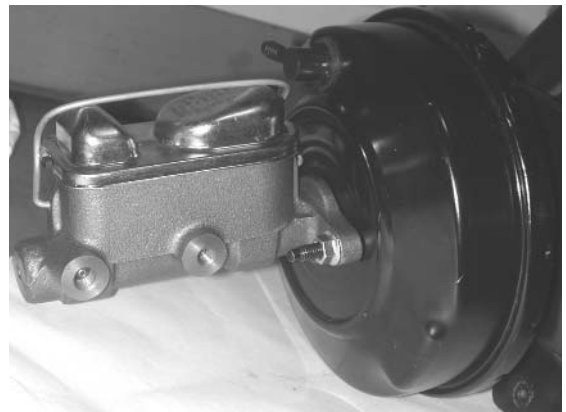

**BM1528
PARTS LIST
BOOSTER, MASTER 71-73 MUSTANG**

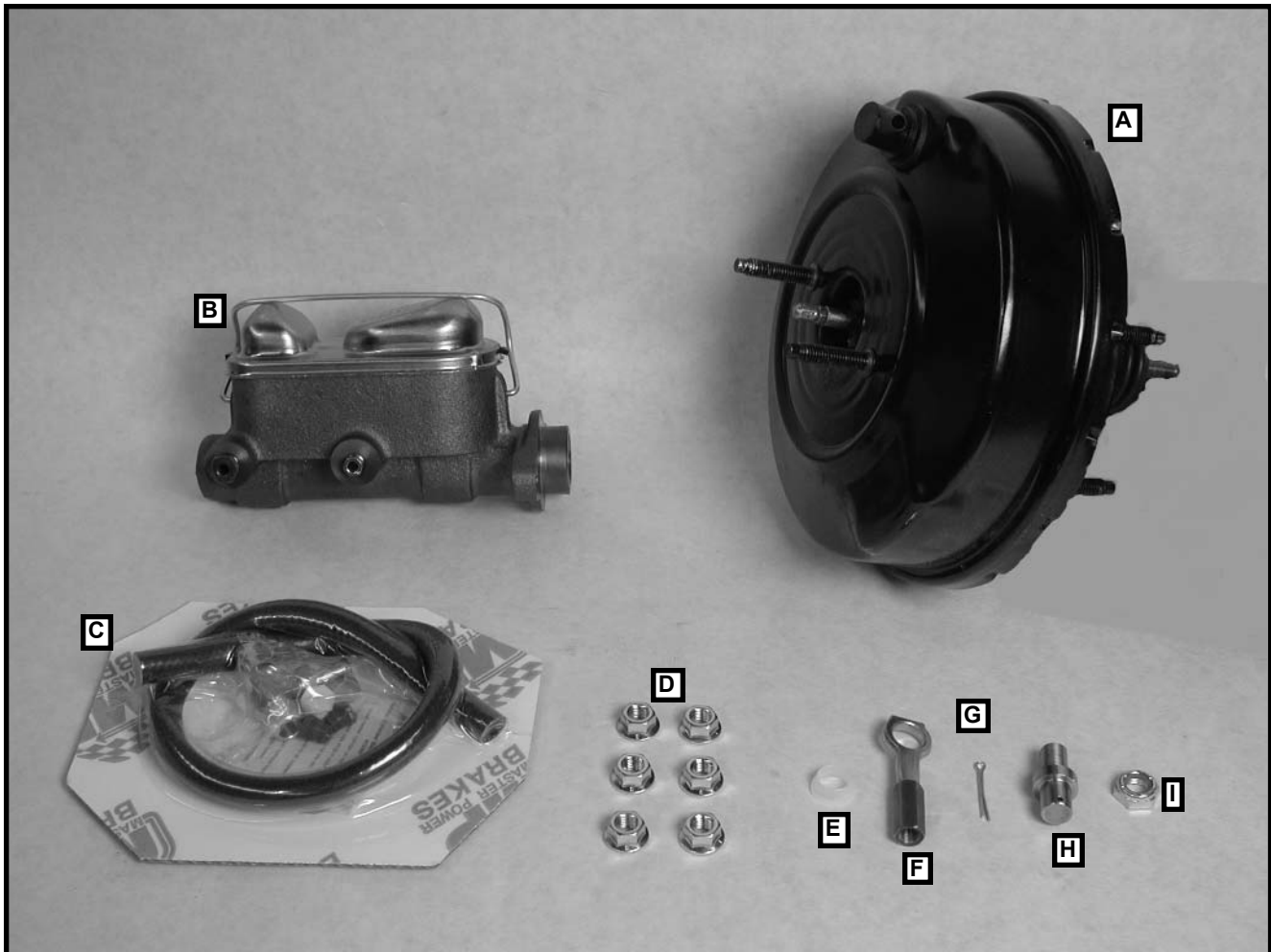

PARTS LIST

- A) (1) BS1523 BOOSTER, 71-73 MUSTANG
- B) (1) MC11378M MASTER CYL. MANUAL, FORD
1" BORE, 3/8" STROKE
DUAL RESERVOIR
- C) (1) HS4001K HOSE KIT, VACUUM
 - (1) AC2002 BLEEDER KIT, USED IN DUAL MASTER CYL. APPL.
 - (1) HS4001-2 VACUUM HOSE, 2FT PER KIT
 - (1) HW40066 FITTING, MALE ELBOW, 3/8 O.D. TUBE, 3/8 PIPE VAC. HOSE
 - (1) HW413-66 FITTING, MALE INVERTED 3/8 HOSE I.D., 3/8 O.D. MANIFOLD VAC. HOSE
- D) (6) 100CNFWZ NUT, M10, SERRATED FLANGE
- E) (1) BU1523 BUSHING, NYLON FORD FITS BOOSTER ROD, PEDAL PIN
- F) (1) PR1523 PUSH ROD, FORD END 71-73 MUSTANG BOOSTER
- G) (1) 12R100PCOZ COTTER PIN, 1/8 X 1"
- H) (1) HW1524 PIN, PEDAL FORD MUSTANG
- I) (1) 50FNNEZNTNTE NYLOCK THIN #305299

MASTER POWER 888-533-1199