



## **2011+ Mustang GT Extreme Exhaust Kits**

**P/N: 421126 , 421127, 421410  
(13115230SRK, 13115230RRK, & R1313-5231)**

## **2011+ Mustang V6 Extreme Exhaust Kits**

**P/N: 421144, 421145  
(1311V6-5230SRK & 1311V6-5230RRK)**

# **Installation Instructions**

Before installing your ROUSH Extreme Exhaust, please read through the entire installation procedure and check to make sure all items are present. Contact ROUSH Customer Service at 1-800-59-ROUSH, 9:00 AM to 5:00 PM weekdays, for any questions regarding fit or instructions that are unclear to you.

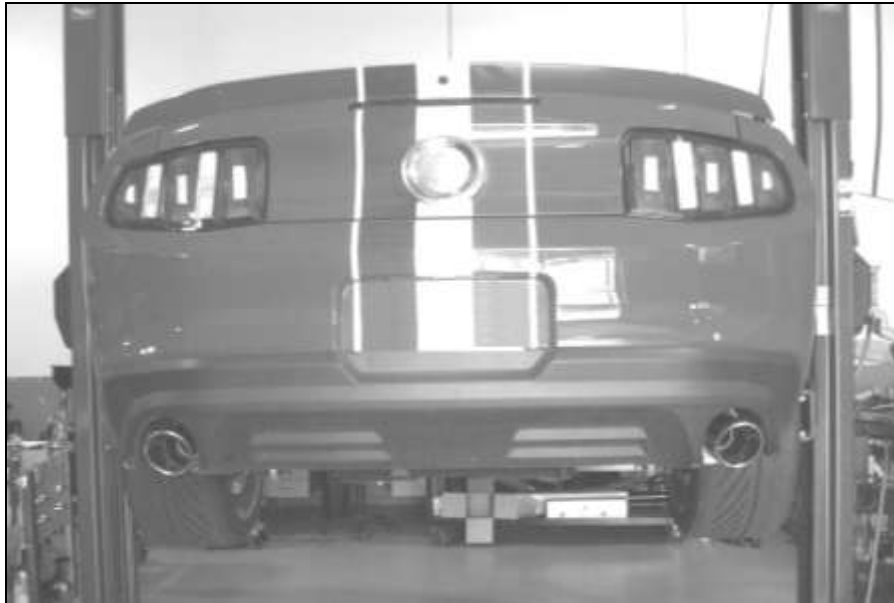

### **NOTE:**

All illustrations in this manual are representative of the 2011 Roush Performance Products "ROUND TIP" Extreme Exhaust System. The procedures and torque values for the "SQUARE TIP" system are exactly the same.



**Packaging List for Complete V8 Exhaust Kits**

<b>Exhaust Kit - Square Tip (Roush PN: 13115230SRK)</b>		
<b>Item Description</b>	<b>Part Number</b>	<b>Qty/Kit</b>
Muffler Asy - Square Tip - LH	13115232	1
Muffler Asy - Square Tip - RH	13115230	1
Exhaust Tip - Square - LH	13115232SQTIP	1
Exhaust Tip - Square - RH	13115230SQTIP	1
Clamp - Muffler to Tip	R12060014-00	2
Clamp - Muffler to Mid-pipe	93-0088	2
Installation Manual - Exhaust Kit	13115230IM	1

<b>Exhaust Kit - Round Tip (Roush PN: 13115230RRK)</b>		
<b>Item Description</b>	<b>Part Number</b>	<b>Qty/Kit</b>
Muffler Asy - Round Tip - LH	13115232	1
Muffler Asy - Round Tip - RH	13115230	1
Exhaust Tip - Round	13115230RTIP	2
Clamp - Muffler to Tip	R12060014-00	2
Clamp - Muffler to Mid-pipe	93-0088	2
Installation Manual - Exhaust Kit	13115230IM	1

<b>Exhaust Kit - Square Tip (Roush PN: R1313-5231)</b>		
<b>Item Description</b>	<b>Part Number</b>	<b>Qty/Kit</b>
Muffler Asy - Square Tip - LH	13115232	1
Muffler Asy - Square Tip - RH	13115230	1
Exhaust Tip - Square - LH	1313-5232-TIP	1
Exhaust Tip - Square - RH	1313-5230-TIP	1
Clamp - Muffler to Tip	R12060014-00	2
Clamp - Muffler to Mid-pipe	93-0088	2
Installation Manual - Exhaust Kit	13115230IM	1



**Packaging List for Complete V6 Exhaust Kits**

<b>Exhaust Kit - Square Tip (Roush PN: 1311V6-5230SRK)</b>		
<b>Item Description</b>	<b>Part Number</b>	<b>Qty/Kit</b>
Muffler Asy - Square Tip - LH	1311V6-5232	1
Muffler Asy - Square Tip - RH	1311V6-5230	1
Exhaust Tip - Square - LH	13115232SQTIP	1
Exhaust Tip - Square - RH	13115230SQTIP	1
Clamp - Muffler to Tip	R12060014-00	2
Clamp - Muffler to Mid-pipe	93-0102	2
Installation Manual - Exhaust Kit	13115230IM	1

<b>Exhaust Kit - Round Tip (Roush PN: 1311V6-5230RRK)</b>		
<b>Item Description</b>	<b>Part Number</b>	<b>Qty/Kit</b>
Muffler Asy - Round Tip - LH	13115232	1
Muffler Asy - Round Tip - RH	1311V6-5230	1
Exhaust Tip - Round	13115230RTIP	2
Clamp - Muffler to Tip	R12060014-00	2
Clamp - Muffler to Mid-pipe	93-0102	2
Installation Manual - Exhaust Kit	13115230IM	1

**Equipment and Supplies Required**

- 3/8" Drive Ratchet
- 3/8" Drive Extension 3"
- 15mm Socket
- Pry Bar
- Spray Lubricant



## **LIMIT OF LIABILITY STATEMENT**

The information contained in this publication was accurate and in effect at the time the publication was approved for printing and is subject to change without notice or liability. ROUSH Performance Products (RPP) reserves the right to revise the information presented herein or to discontinue the production of parts described at any time.

## **SAFETY REQUIREMENTS**

**STOP! READ IMPORTANT SAFETY CAUTIONS AND WARNINGS BEFORE PROCEEDING.**

### **IMPORTANT SAFETY NOTICE**

Appropriate disassembly, assembly methods and procedures are essential to ensure the personal safety of the individual performing the kit installation. Improper installation due to the failure to correctly follow these instructions could cause personal injury or death. Read each step of the installation manual carefully before starting the actual installation.

1. Always wear safety glasses for eye protection.
2. Place ignition switch in the OFF position.
3. Always apply the parking brake when working on a vehicle.
4. Block the front and rear tire surface to prevent unexpected vehicle movement.
5. If working without a lift, always consult vehicle manual for correct lifting specifications.
6. Operate the engine only in well-ventilated areas to avoid exposure to carbon monoxide.
7. Do not smoke or use flammable items near or around the fuel system.
8. Use chemicals and cleaners in well-ventilated areas.
9. Batteries produce explosive gases, which can cause personal injury. Therefore, do not allow flames, sparks or flammable substances to come near the battery.
10. Keep hands and any other objects away from the radiator fan blades.
11. Keep yourself and your clothing away from moving parts when the engine is running.
12. Do not wear loose clothing or jewelry that can get caught in rotating parts or scratch surface finishes.
13. Allow the engine, cooling system, brakes and exhaust to cool before working on a vehicle.

### **WORK SAFELY!**

Perform this installation on a good clean level surface for maximum safety and with the engine turned off.

# ROUSH

THE **ART** OF PERFORMANCE ENGINEERING

## Original Exhaust System Removal

Note: With a used vehicle, we suggest a penetrating spray lubricant to be applied liberally to all exhaust fasteners and allowing a significant period of time for the chemical to lubricate the threads before attempting to disassemble.

1. Loosen the two (2) clamps shown in Figure 1 located just behind the h-pipe.

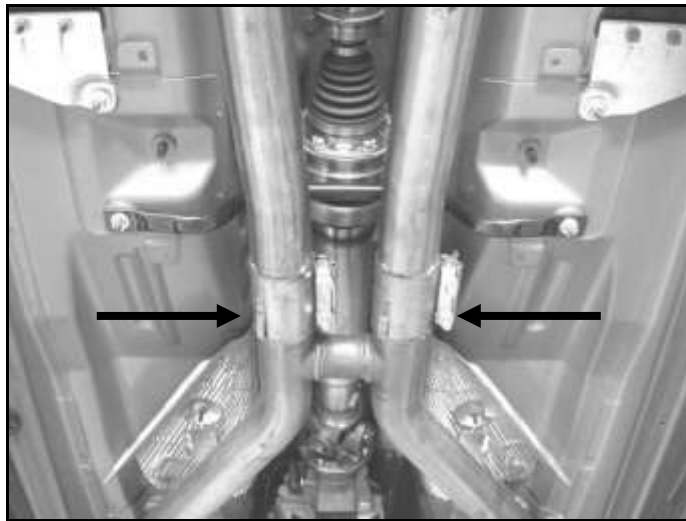

**Figure 1**

2. Loosen the two (2) clamps shown in Figure 2 located just in front of each muffler assembly.

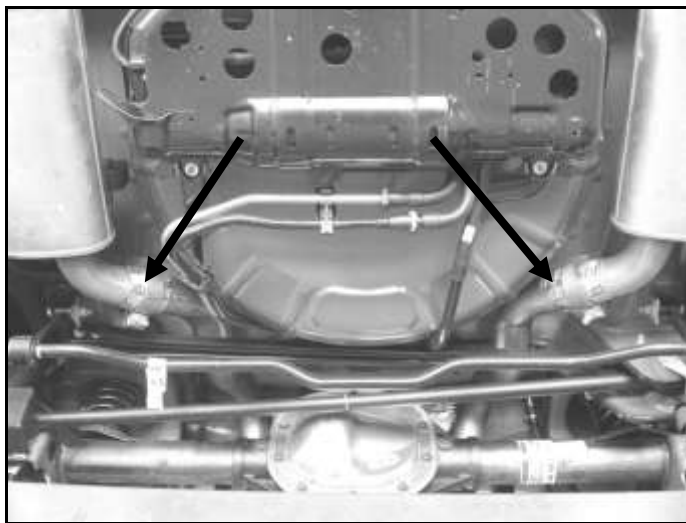

**Figure 2**

3. Beginning with the left (driver) side, using a flat blade screwdriver, pull the clip as shown in Figure 3 to disengage it from the pipe.



**Figure 3**

4. Remove the left (driver) side intermediate pipe shown in Figure 4 by removing the front of the pipe first then sliding it out of the muffler assembly.



**Figure 4**

# ROUSH

THE **ART** OF PERFORMANCE ENGINEERING

5. Remove the factory clamp for use during the installation of your new exhaust system.
6. Repeat steps 3 thru 5 for the removal of the right side intermediate pipe.
7. Lubricate all hangers and rubber isolators.
8. On left (driver) side muffler assembly, remove the muffler from the vehicle as shown in Figure 5.



**Figure 5**

9. Repeat step 7 for the removal of the right (passenger) side muffler assembly.

***Warning: Use extreme caution during installation. Torque all fasteners according to manufacturer's torque values and tightening sequence. DO NOT use air impact tools to tighten fasteners on ROUSH Performance Products Exhaust Systems. Use of such tools may result in bent flanges or gasket contact areas leading to exhaust leaks.***

## RPP Exhaust System Installation

1. Remove clear plastic covering from both the RH & LH mufflers.
2. Place one of the provided spherical clamps over the expanded inlet pipe of the left (driver) side muffler assembly and set it up into position as shown in Figure 6. Install the hangers into the three factory rubber isolators.

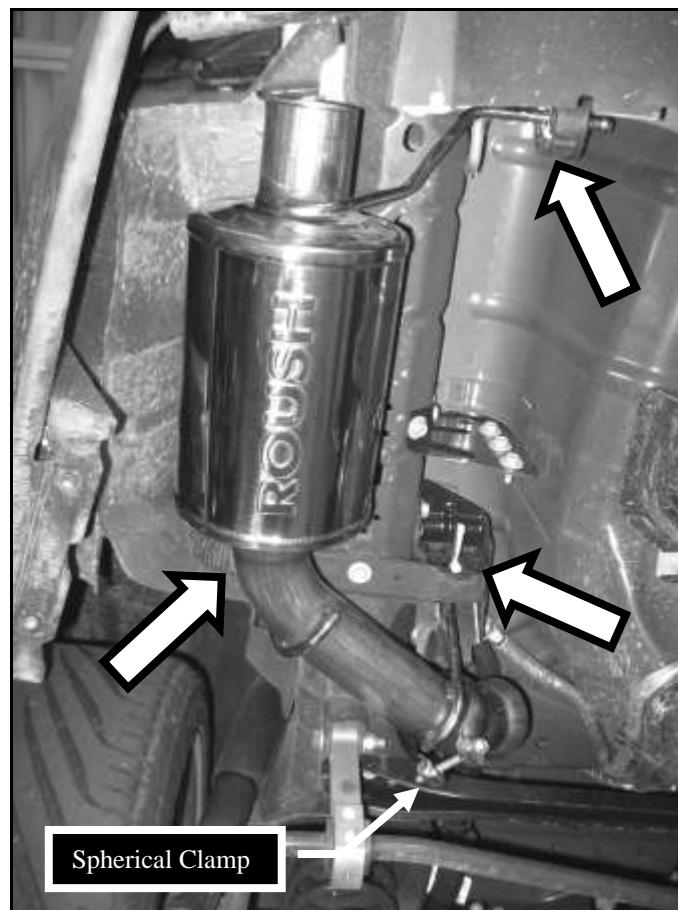
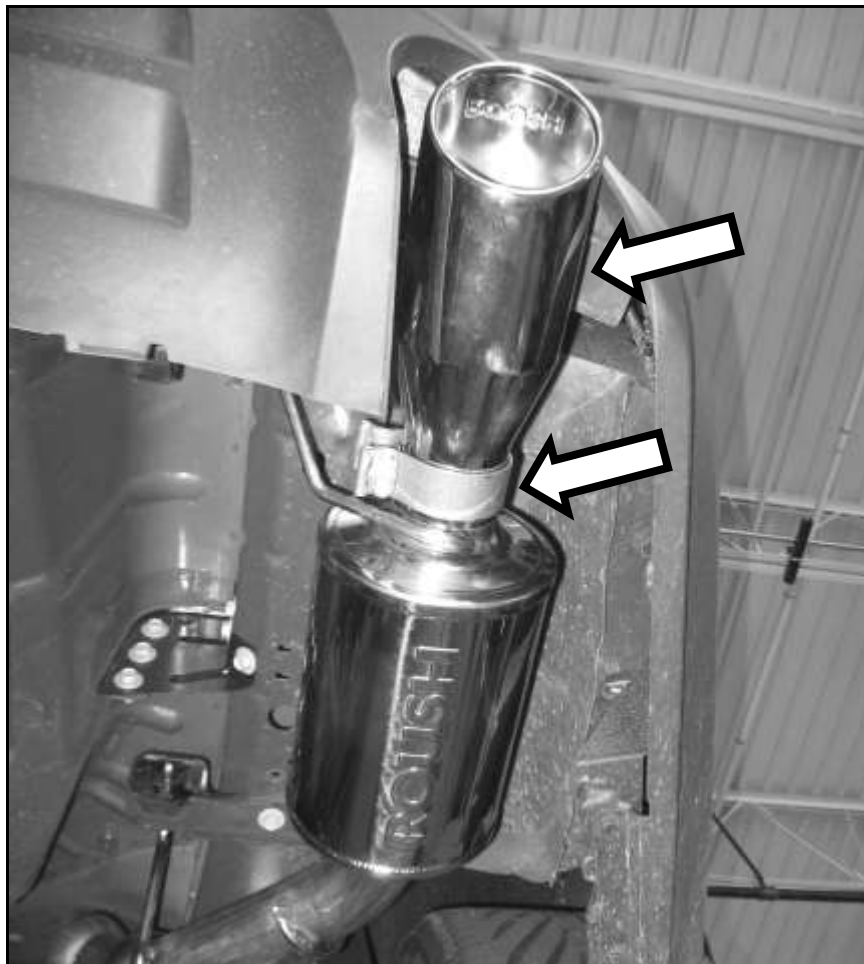

**Figure 6**

3. Repeat step 2 for the installation of the right (passenger) side muffler assembly.



4. Place the original clamp over the expanded end of the left (driver) side intermediate pipe and set it back into position by first installing the rear portion into the muffler assembly.
5. Repeat step 4 for the installation of the right (passenger) side over axle pipe.
6. Install the exhaust tips and clamps onto the muffler assemblies as shown in Figure 7.



**Figure 7**

# ROUSH

THE **ART** OF PERFORMANCE ENGINEERING

7. Check your exhaust system for proper clearance under the vehicle and also for tip alignment as shown in Figure 8.



**Figure 8**

8. Once position and alignment has been determined to be correct, tighten the clamps to the torque values shown in Figure 9. Torque the exhaust tip clamps to 30 Nm.

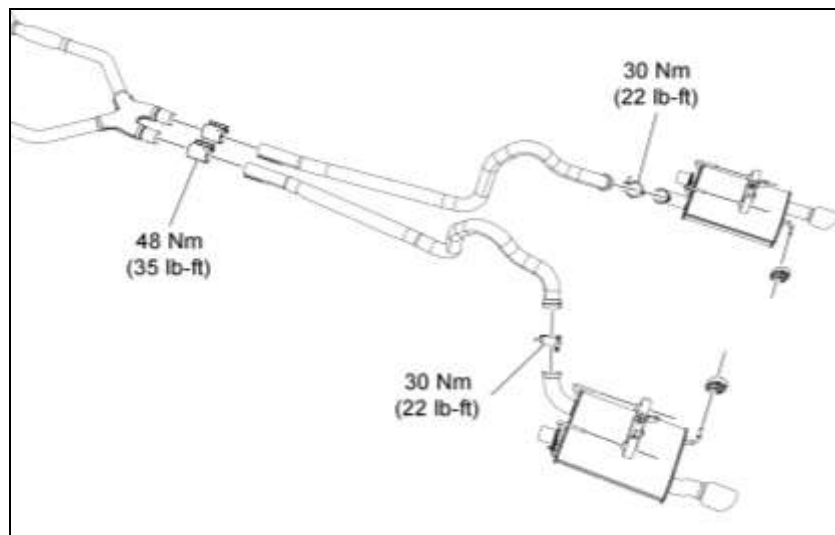

**Figure 9**

# ROUSH

THE **ART** OF PERFORMANCE ENGINEERING

9. Before starting your vehicle, make sure to check all wires, hoses, brake lines, body parts and tires for safe clearance from the exhaust system.
10. Start vehicle and check for any leaks. If any leaks are found, determine cause (such as loose or incorrectly positioned clamp) and repair as necessary.

**Congratulations!!!** You have completed the installation of the ROUSH Performance Products, Ford Mustang Exhaust Kit. It is recommended that you save all parts removed from your vehicle during the installation of this kit.

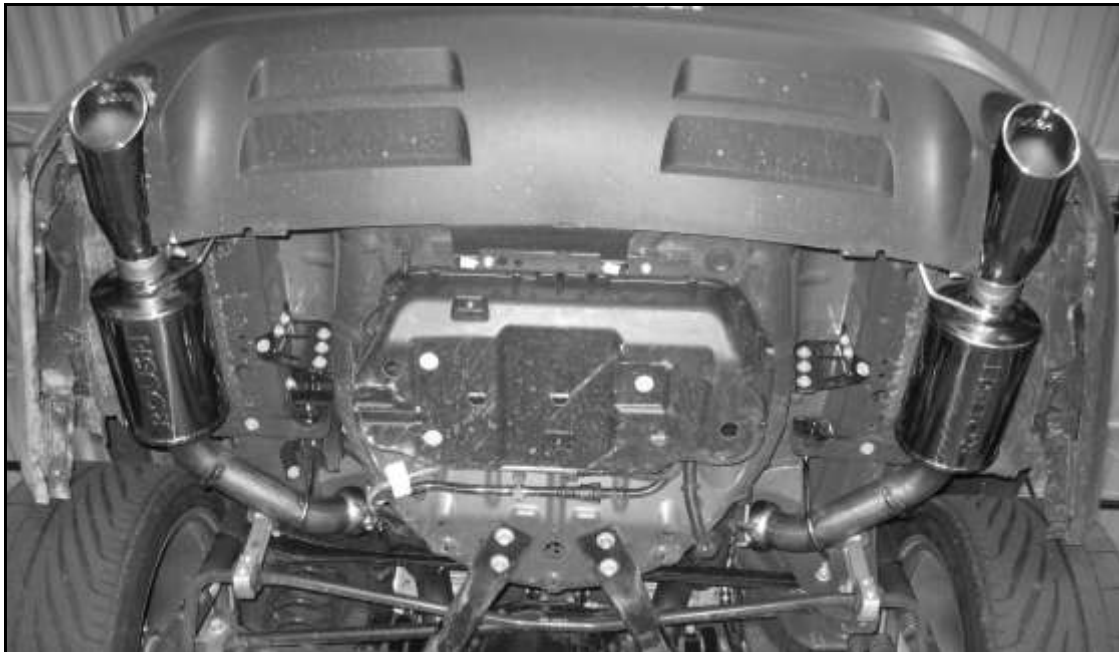



## **WARRANTY**

All retail parts carry a 90-day warranty from the date of purchase. This warranty covers defects in materials or workmanship, and does not include (i) normal wear and tear, environmental conditions, improper installation; (ii) road hazards, misuse, abuse, neglect, accidents, collision, fire, theft, freezing, vandalism, riot, explosion, or objects striking the vehicle; (iii) misusing the vehicle, such as driving over curbs, overloading, racing, or using the vehicle as a stationary power source; (iv) altering, disassembling or modifying the parts; (v) defects caused or induced by failures, breakdowns, or damage by other parts, components or the vehicle; (vi) subjecting the parts to excessive moisture or water or any motor vehicle fluids (e.g.: oil, anti-freeze, battery acid, brake fluid, etc.); (vii) acts of God, natural disasters and other similar causes beyond the reasonable control of ROUSH; or (viii) application of chemicals that affect the parts. This Limited Warranty does not cover surface deterioration of paint, trim, and appearance items that result from use and/or exposure to the elements, such as stone chips, scratches, bird droppings, lightning, hail, windstorm, dings, dents, earthquake, road salt, tree sap, water or flood.

ROUSH SHALL NOT BE LIABLE TO REIMBURSE CUSTOMER/DEALER FOR INCIDENTAL OR CONSEQUENTIAL DAMAGES RESULTING FROM THE INSTALLATION OR USE OF ANY PRODUCT SOLD THROUGH THIS CATALOG OR ARISING OUT OF ANY BREACH OF WARRANTY. EXCEPT AS MAY BE STATED IN THIS CATALOG, ROUSH DISCLAIMS ALL EXPRESS AND IMPLIED WARRANTIES, INCLUDING THE WARRANTIES OF MERCHANTABILITY AND FITNESS FOR A PARTICULAR PURPOSE. IN NO EVENT SHALL ROUSH'S LIABILITY EXCEED THE PRICE PAID BY CUSTOMER/DEALER FOR PRODUCTS SOLD REGARDLESS IF ROUSH HAS BEEN ADVISED IN ADVANCE OF ANY POTENTIAL PROBLEM OR IF A CLAIM IS BASED ON CONTRACT, TORT, STRICT LIABILITY, PRODUCT LIABILITY OR OTHERWISE. SOME STATES DO NOT ALLOW THE EXCLUSION OR LIMITATION OF IMPLIED WARRANTIES OR THEIR DURATION, OR LIABILITY FOR INCIDENTAL OR CONSEQUENTIAL DAMAGES, SO THE ABOVE EXCLUSIONS OR LIMITATIONS MAY NOT APPLY.