

IMPORTANT

YOUR NEW CENTERFORCE® CLUTCH ASSEMBLY AND FLYWHEEL HAVE BEEN DESIGNED TO BE USED WITH LOCATING DOWEL PINS.

THE ALIGNMENT DOWEL PINS ARE USED TO PROPERLY LOCATE THE PRESSURE PLATE TO THE FLYWHEEL FOR BALANCE PURPOSES AS WELL AS TO ADD PRESSURE PLATE TO FLYWHEEL SHEAR STRENGTH. THE ALIGNMENT DOWEL PINS SHOULD ALWAYS BE REPLACED IF THEY ARE DAMAGED, BROKEN OFF, OR MISSING FROM THE FLYWHEEL.

FAILURE TO INSTALL OR REPLACE THE DOWEL PINS AS REQUIRED MAY RESULT IN CLUTCH VIBRATION, IMPROPER CLUTCH OPERATION, AND POSSIBLE CLUTCH FAILURE WHICH MAY VOID THE WARRANTY!



"NOTE" Centerforce tip sheets are for general reference only. Please refer to your owners manual for vehicle specifications.

IMPORTANT

IMPORTANT

FORD MUSTANGS WITH CABLE CLUTCH LINKAGE

To help achieve proper cable clutch linkage geometry, you will need to measure your flywheel deck height (distance from the flywheel crankshaft flange surface to the clutch friction surface) as shown in FIG 1. Aftermarket flywheel variances and/or flywheel resurfacing may have reduced your flywheel deck height from the Original Equipment (O.E.) flywheel measurement of 0.960”.

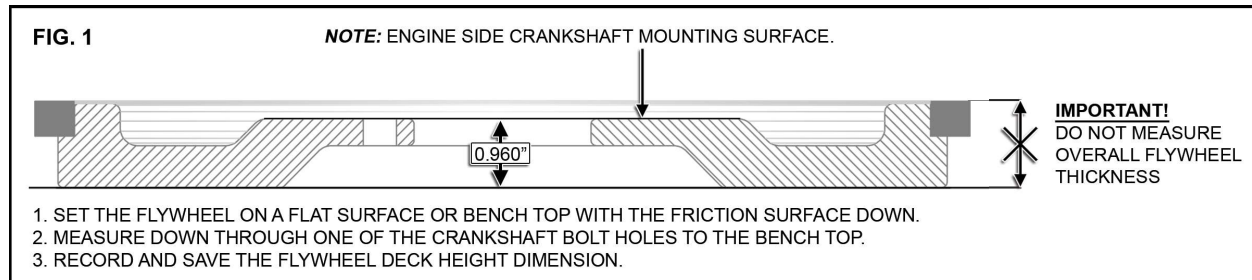

FIG 2 shows the O.E. clutch fork pivot ball height of 3.650” as measured from the engine block side of the Bellhousing plate (block saver) to the top of the clutch fork pivot ball. If your flywheel deck height measures between 0.910” and 0.960”, be sure your clutch fork pivot ball height is 3.650”. If your flywheel deck height is less than 0.910” you will need to adjust the clutch fork pivot ball height to accommodate the thinner flywheel as follows:

Enter your flywheel Deck Height measurement here: _____ and SUBTRACT from 0.960” (O.E. standard flywheel deck height) = “Pivot ball adjustment distance”.

Then: SUBTRACT “Pivot ball adjustment distance” from 3.650” (O.E. standard pivot ball height) to find the correct clutch fork pivot ball height.

EXAMPLE: a flywheel deck height of 0.850” SUBTRACT from 0.960” = 0.110”

Use an aftermarket adjustable pivot ball to move the clutch fork pivot ball 0.110” CLOSER to the engine:

0.110” SUBTRACT from 3.650” = 3.540” (adjust the clutch fork pivot ball height to 3.540” in this example.)

These dimensions are for cable clutch release systems using Centerforce P/N: N1714 release (O.E. type) bearing. For use with other release bearings and/or if you have questions, please contact our Technical Department at: (928) 771-8422

Notes:

- 1) If your flywheel deck height thickness is significantly below the O.E. specification, the clutch disc springs may contact the flywheel crankshaft bolts resulting in improper or failed clutch operation.
- 2) Centerforce DOES NOT recommend any shims/spacers or aftermarket balance plates to be used between the crankshaft and the flywheel.

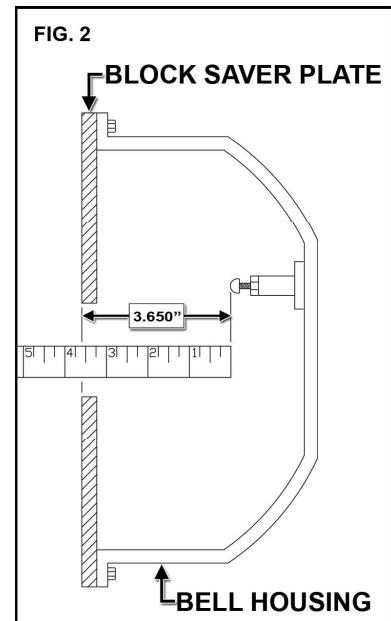

PIVOT BALL REFERENCE INFORMATION

NON ADJUSTABLE
FORD MOTOR CO.
P/N D5FZ-7B602A

ADJUSTABLE PIVOT BALLS
LAKEWOOD / MR GASKET P/N: 15502 (Short Length)
LAKEWOOD / MR GASKET P/N: 15503 (Mid Length)
McLEOD P/N: 16909

IMPORTANT

MECHANICAL CLUTCH LINKAGE GEOMETRY FINAL CHECK

Once the clutch assembly, release bearing, clutch fork and Bellhousing are bolted in place you can visually ensure the clutch fork ball stud is adjusted properly. Do not connect the remainder of the clutch linkage at this point. Move the clutch fork by hand until the release bearing contacts the clutch fingers. The outer end of the clutch fork should be pointed towards the transmission, behind the ball stud center as shown in FIG 3. If the outer end of the clutch fork is ahead of the ball stud centerline (pointing towards the engine), your clutch linkage is incorrect. Please re-visit the clutch fork pivot ball adjustment instructions or call the Centerforce Tech line at (928) 771-8422 for further assistance. Next, fully retract the release bearing away from the clutch fingers and visually check to insure that you have at least 1/4" clutch wear allowance gap between the release bearing and the clutch fingers. Once the geometry is correct, connect the remainder of the clutch linkage and then adjust to where the clutch engagement point is approximately half-way up the pedal travel. Small adjustments can be made to suit individual driving preferences. Throughout the service life of your clutch, be sure to periodically check the wear allowance gap and adjust as needed. Caution! If the clutch engagement point is at or near the top of your clutch pedal travel – your clutch may be pre-loaded (release bearing too close or touching the clutch fingers). Continued operation with the clutch in a pre-loaded condition will void the warranty and cause poor performance as well as significant damage.

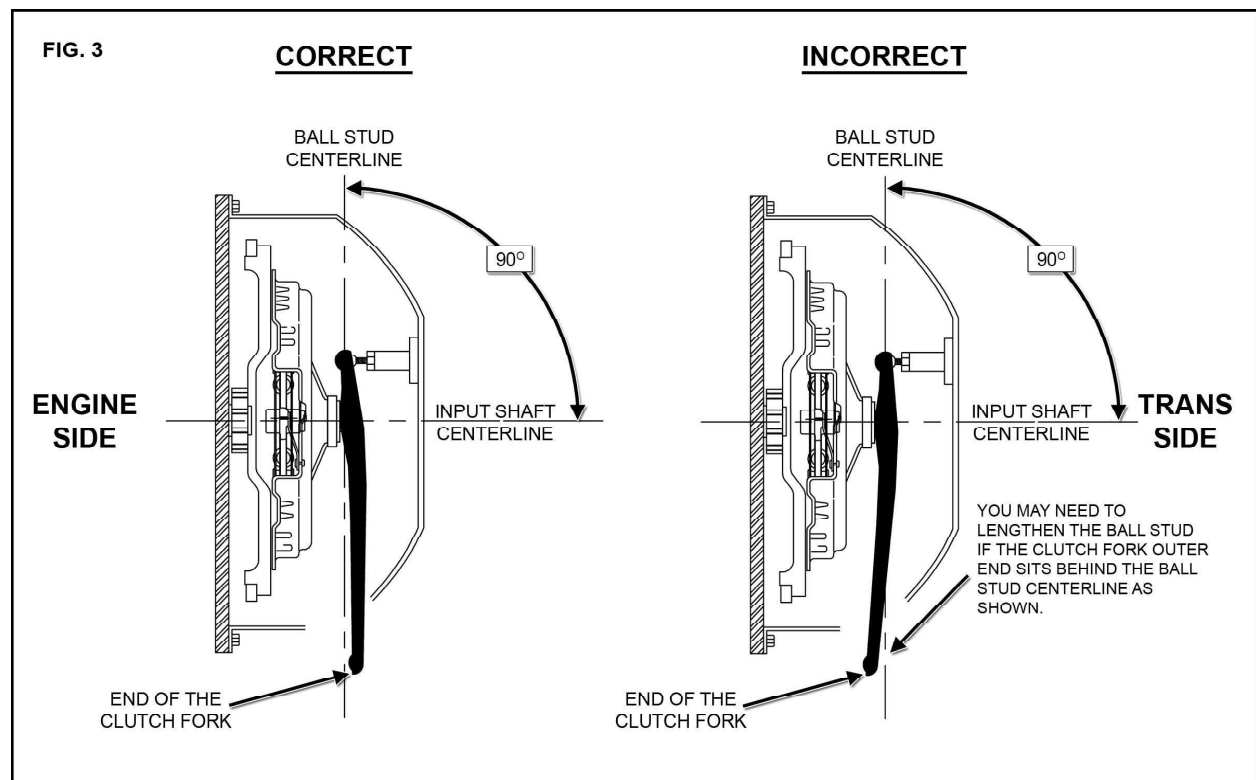

"NOTE" Centerforce tip sheets are for general reference only. Please refer to your owners manual for vehicle specifications.



IMPORTANT



Customers requiring
24-month SFI activation.



Thank you for purchasing clutch components certified by Centerforce to SFI Specification 1.1. Some competition sanctioning bodies require clutch components to be SFI certified every 24 months. The enclosed clutch component(s) contain the official SFI decal and corresponding serial number etched into the part. Please note that the component SFI ACTIVATION DATE is also etched near the SFI serial number. SFI 24-month certification STARTS from this SFI ACTIVATION DATE. Centerforce clutch components have an indefinite shelf life, however, due to the chain of commerce, the enclosed components may arrive to customers beyond this initial SFI ACTIVATION DATE. If you need full 24 months SFI certification to conform to competition rules, Centerforce can issue a new SFI serial number and SFI ACTIVATION DATE free of charge. To request a fresh SFI ACTIVATION DATE from Centerforce, you MUST contact Centerforce prior to installation and supply a copy of your proof of purchase. This request MUST be submitted within 30 days of purchase. If you require this service, please completely fill out the enclosed SFI activation form and return to Centerforce with a copy of your proof of purchase. Forms and receipts can be sent via Mail, Fax, or Email. If needed, SFI activation forms can also be obtained from our website: www.centerforce.com. Should you have questions or if you require further information please contact Centerforce customer service at (800) 932-5882. Information specifically about SFI certification can be found at www.sfifoundation.com (Reference SFI Clutch/Flywheel Specification 1.1).

IMPORTANT! This activation service is ONLY applicable to new components within 30 days of purchase. Centerforce components that have been SFI certified and used in competition MAY be eligible for re-certification but ONLY after the component(s) have been returned to Centerforce for inspection. Please obtain a Return Merchandise Authorization (RMA) number for inspection and re-certifications. Fee for this service may vary.

If you are NOT competing under specific sanctioning body rules, then the SFI activation date is not relevant to your application or your vehicle use. In this case feel free to use your Centerforce product regardless of the SFI activation date.

Ph: (800) 932-5882
Fax: (928) 771-8322
Email: sales@centerforce.com

Centerforce Clutches
2266 Crosswind Dr.
Prescott, AZ 86301

Email Address: _____

Full Name: _____

Date Purchased: _____

Street Address: _____

Part #: _____

City: _____

Current SFI #: _____

State: _____

Note: A copy of your receipt/proof of purchase is required to obtain an updated SFI Activation Date and SFI Number.

Zip: _____

Country: _____

Phone: _____

Please do not write below this line, completed by Centerforce!

New SFI #: _____

Date Certified: _____

Certified By: _____

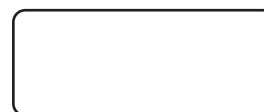

Keep this for your records once the SFI Label is affixed.

IMPORTANT

MUSTANG 5.0L AND 4.6L 1979-2004

CENTERFORCE RECOMMENDS THE FOLLOWING ADJUSTMENT PROCEDURES BE PERFORMED IMMEDIATELY AFTER THE NEW CLUTCH IS INSTALLED, (BEFORE ROAD TESTING), THEN AFTER THE 500 MILE BREAK IN PERIOD AND EVERY 3,000 TO 5,000 MILES THEREAFTER OR AS REQUIRED

CARS WITH THE STOCK RATCHET TYPE QUADRANT- AS DESCRIBED IN THE FACTORY SERVICE MANUAL, PROPER CLUTCH CABLE ADJUSTMENT IS ACCOMPLISHED BY SIMPLY PULLING UPWARD (TOWARDS THE DRIVERS SEAT) ON THE CLUTCH PEDAL (YOU MAY HEAR A CLICKING OR A RATCHETING SOUND FROM UNDER THE DASHBOARD). THIS WILL ALLOW THE QUADRANT PAWL TO RELEASE AND RESET THE CABLE ADJUSTMENT AUTOMATICALLY.

CARS WITH AN AFTER MARKET (ONE PIECE) ADJUSTABLE QUADRANT- (MANUAL ADJUSTMENT). MOVE THE CABLE ADJUSTING NUT (AT THE RELEASE BEARING ARM) TO OBTAIN 1/8" MINIMUM TO 1/4" OF FREEPLAY IN THE CABLE (SEE DIAGRAM). AT THIS SETTING THE CLUTCH SHOULD ENGAGE AT ONE THIRD TO ONE HALF OF THE PEDAL TRAVEL DISTANCE UP FROM THE FLOOR BOARD. IF THE ENGAGEMENT POINT DOES NOT FALL WITHIN THIS RANGE; LOOSEN THE ADJUSTING NUT (ADD SLACK TO THE CABLE) TO LOWER THE POINT OF ENGAGEMENT, OR THE OPPOSITE, TIGHTEN THE CABLE (MAKING SURE TO MAINTAIN THE PROPER FREEPLAY IN THE CABLE), TO RAISE THE ENGAGEMENT POINT UNTIL THE PROPER SETTING IS ACHIEVED. BE SURE TO LOCK THE CABLE ADJUSTING NUT WITH THE JAM NUT WHEN THE ADJUSTMENT IS COMPLETED.

ADJUSTMENT DIAGRAM FOR ADJUSTABLE QUADRANT

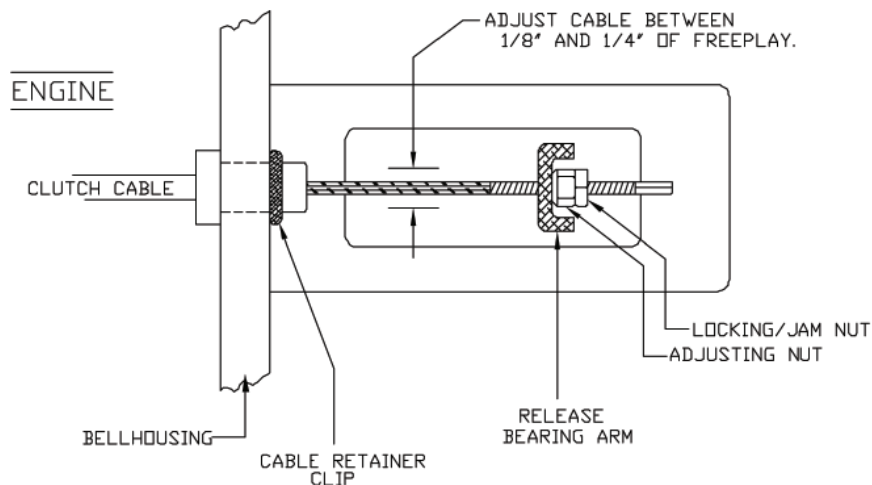

"NOTE" Centerforce tip sheets are for general reference only. Please refer to your owners manual for vehicle specifications.

IMPORTANT

IMPORTANT

FORD CARS AND TRUCKS

1979-1997

ALL FORD TRANSMISSIONS WITH ALUMINUM INPUT SHAFT RETAINER BEARING COLLAR

CLUTCH OPERATION PROBLEMS MAY OCCUR DUE TO THE INPUT SHAFT BEARING RETAINER COLLAR WEARING PREMATURELY, CAUSING THE THROWOUT BEARING TO BIND AND MISALIGN. THIS BINDING CAN RESULT IN ERRATIC CLUTCH OPERATION, INCLUDING HIGH PEDAL EFFORT, IMPROPER CLUTCH RELEASE OR ENGAGEMENT, OR CLUTCH CHATTER.

WHEN INSTALLING A NEW CLUTCH ASSEMBLY, IT IS IMPORTANT TO CHECK THE INPUT SHAFT BEARING RETAINER COLLAR, THE THROW OUT BEARING ARM, AND THE THROW OUT BEARING PIVOT BALL OR BRACKET FOR SIGNS OF WEAR. **IF THEY SHOW ANY SIGNS OF WEAR, THEY WILL NEED TO BE REPLACED.**

SOME OTHER SYMPTOMS OF A WORN INPUT SHAFT RETAINER BEARING COLLAR ON A HYDRAULIC SYSTEM OTHER THAN PREVIOUSLY MENTIONED, ARE CRACKING OF THE FIREWALL AROUND THE CLUTCH MASTER CYLINDER MOUNTING DUE TO FLEXING. THIS IS A COMMON OCCURRENCE ON LATE MODEL TRUCKS.

ON CABLE OPERATED SYSTEMS, IF THE INPUT SHAFT RETAINER BEARING COLLAR IS WORN, THE CLUTCH ADJUSTMENT MECHANISM MAY NOT PROPERLY OPERATE. THIS MAY CAUSE IMPROPER CLUTCH ADJUSTMENT, RESULTING IN IMPROPER RELEASE OR SLIPPAGE DUE TO THE ASSEMBLY NOT FULLY ENGAGING.

TO DETERMINE IF THE BEARING RETAINER COLLAR AND RELATED ITEMS ARE WORN AND NEED REPLACEMENT, CHECK FOR ANY SCORING OR WEAR THAT RUNS THE LENGTH OF THE RETAINER BEARING COLLAR OR WEAR THAT ENCIRCLES THE COLLAR. INSPECT THE CONTACT POINTS ON THE THROW OUT BEARING ARM WHERE THE THROW OUT BEARING MAKES CONTACT, THE SOCKET WHERE THE PIVOT BALL OR BRACKET PIVOTS IN THE THROW OUT BEARING ARM FOR UNEVEN WEAR OR GALLING. CHECK THE PIVOT BALL OR BRACKET FOR WEAR OR DAMAGE. **IF ANY ONE OF THE ITEMS ARE WORN, ALL OF THE PARTS SHOULD BE REPLACED AT THE SAME TIME (INPUT SHAFT RETAINER BEARING COLLAR, THROW OUT BEARING ARM, THROW OUT BEARING PIVOT BALL OR BRACKET, BUSHINGS, ETC.).**

WHEN REPLACING THE INPUT SHAFT BEARING RETAINER COLLAR, REMEMBER TO REPLACE THE INPUT SHAFT SEAL AND GASKET (WHERE APPLICABLE) TO AVOID ANY LEAKAGE AND ASSURE PROPER CLUTCH OPERATION.



"NOTE" Centerforce tip sheets are for general reference only. Please refer to your owners manual for vehicle specifications.

IMPORTANT

IMPORTANT

GENERAL BELLHOUSING ALIGNMENT INSTRUCTIONS

BELLHOUSING ALIGNMENT IS CRUCIAL FOR PROPER CLUTCH FUNCTION AND RELIABILITY OF THE RELATED COMPONENTS. DUE TO MANUFACTURING TOLERANCES OF ENGINE BLOCKS AND BELLHOUSINGS, IT IS POSSIBLE FOR THE TRANSMISSION CENTERLINE AND CRANKSHAFT CENTERLINE TO BE MISALIGNED. THE RESULT OF THIS MISALIGNMENT MAY BE HARD SHIFTING, PILOT BEARING WEAR, TRANSMISSION MAIN SHAFT BEARING WEAR AND FAILURE OF CLUTCH DISC HUB.

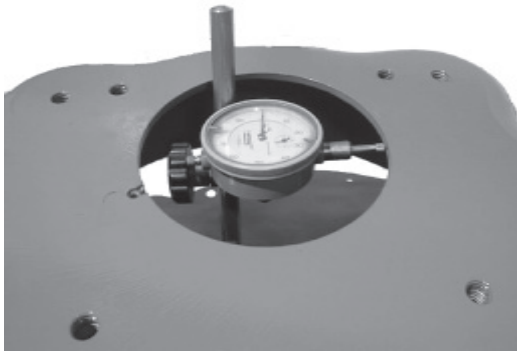

FIRST CHECK BELLHOUSING FOR BORE CONCENTRICITY. INSTALL MAGNETIC BASE TO FLYWHEEL OR PRESSURE PLATE, THEN INSTALL THE INDICATOR TO MEASURE THE BELLHOUSING BORE (SHOWN ABOVE). ROTATE THE CRANKSHAFT AND MARK DOWN THE INDICATOR READINGS (MARKING THE BELLHOUSING WORKS WELL). THE MAXIMUM OUT OF CONCENTRICITY IS .005".



NEXT, THE BELLHOUSING FACE SHOULD BE CHECKED FOR PARALLELISM TO THE BACK OF THE BLOCK. INSTALL THE INDICATOR (AS SHOWN ABOVE). ROTATE THE CRANKSHAFT AND MARK DOWN THE READINGS (BE SURE TO PUSH THE CRANKSHAFT AGAINST THRUST BEARING FOR ACCURATE MEASUREMENT). THE MAXIMUM OUT OF PARALLELISM IS .002"

NOTE: INSPECT BLOCK SURFACE AND BELLHOUSING FOR DENTS, BURRS, PAINT, DEBRIS, ETC. BEFORE INSTALLING AND CHECKING BELLHOUSING ALIGNMENT.



"NOTE" Centerforce tip sheets are for general reference only. Please refer to your owners manual for vehicle specifications.

CONTINUED ON THE BACK SIDE

CONTINUED

TO CORRECT OFF-CENTER CONDITION, SELECT THE OFFSET DOWEL PIN PAIR THAT IS CLOSEST TO ONE-HALF OF THE INDICATOR READING (I.E., IF READING IS .016", 1/2R=.008" USE .007" DOWELS. IF READING IS .024", 1/2R=.012" USE .014 DOWELS).

EXAMPLE

THE BELLHOUSING WAS OFFSET TOWARD TOP OF ENGINE AND SLIGHTLY TO THE LEFT (AS VIEWED FROM BEHIND). TO ALIGN THE BELLHOUSING, INSTALL TWO .014" OFFSET DOWEL PINS WITH THE MAXIMUM OFFSET POSITIONED ROUGHLY AT THE 5 O'CLOCK POSITION.

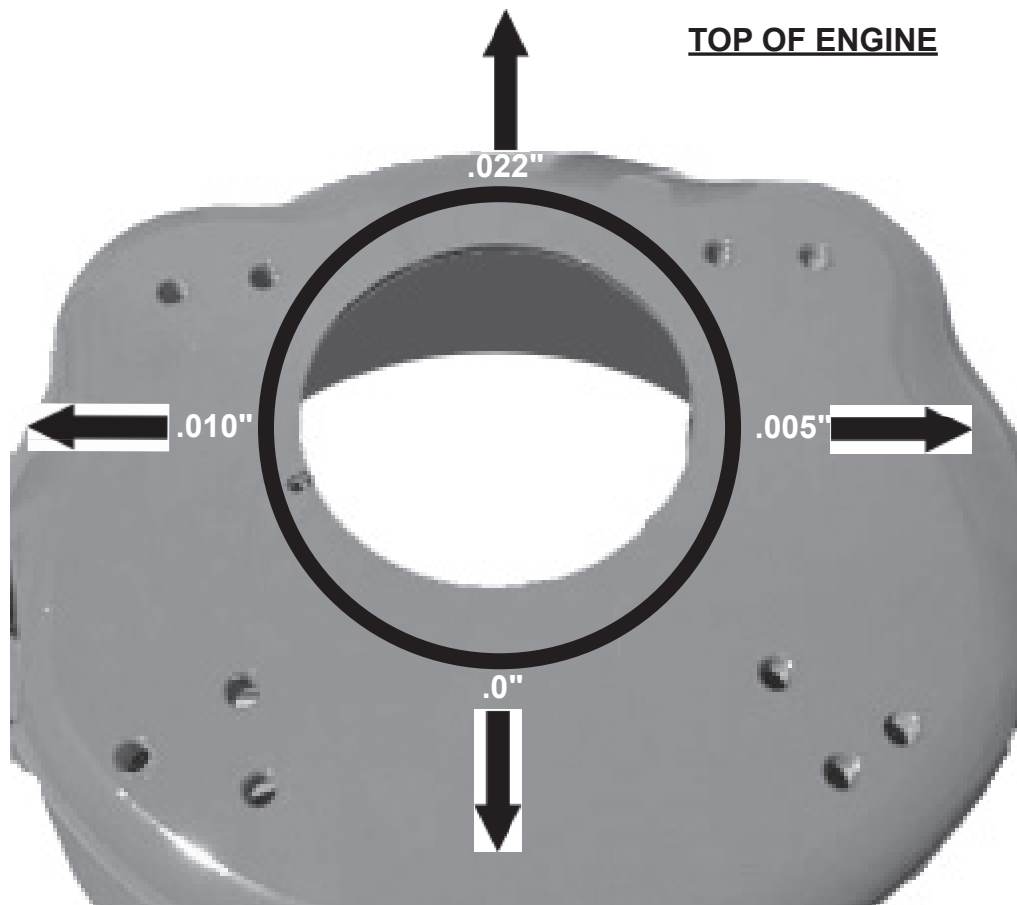

OFFSET DOWEL PIN CHART

TOTAL INDICATOR READING	ONE HALF TOTAL INDICATOR READING			SIZE DOWEL TO BE USED
.012" TO .020"	.006" TO .010"			.007"
.022" TO .034"	.011" TO .017"			.014"
.036" TO .052"	.018" TO .026"			.021"
	GM			FORD/CHRYSLER
	<u>LAKWOOD</u>	<u>MOROSO</u>	<u>TAVIA</u>	<u>LAKWOOD</u>
.007	15920	37934	02701	15950
.014	15930	37936	02702	15960
.021	15940	37938	02703	15970

IMPORTANT

FOR ALL FORD MOTOR VEHICLES USING THROW OUT BEARING PART NUMBER N1714 OR O.E.M. TYPE EQUIVALENT DESIGN (PICTURED BELOW), WHICH IS A SELF ALIGNING TYPE THROWOUT BEARING.

NOTE: SELF ALIGNING TYPE THROWOUT BEARINGS WHEN REMOVED FROM THE BOX MAY APPEAR TO BE OFF CENTER, HOWEVER, THEY ARE NOT DEFECTIVE AND WILL PROPERLY ALIGN DURING USE.

THE FORK SPRING CLIPS MUST BE INSTALLED BETWEEN THE THROWOUT BEARING COLLAR FLANGES. IF THE CLIPS ARE INSTALLED ABOVE THE TOP FLANGE AS SHOWN BELOW, PROPER ADJUSTMENT CANNOT BE MADE.

CORRECT



INCORRECT



"NOTE" Centerforce tip sheets are for general reference only. Please refer to your owners manual for vehicle specifications.

IMPORTANT