

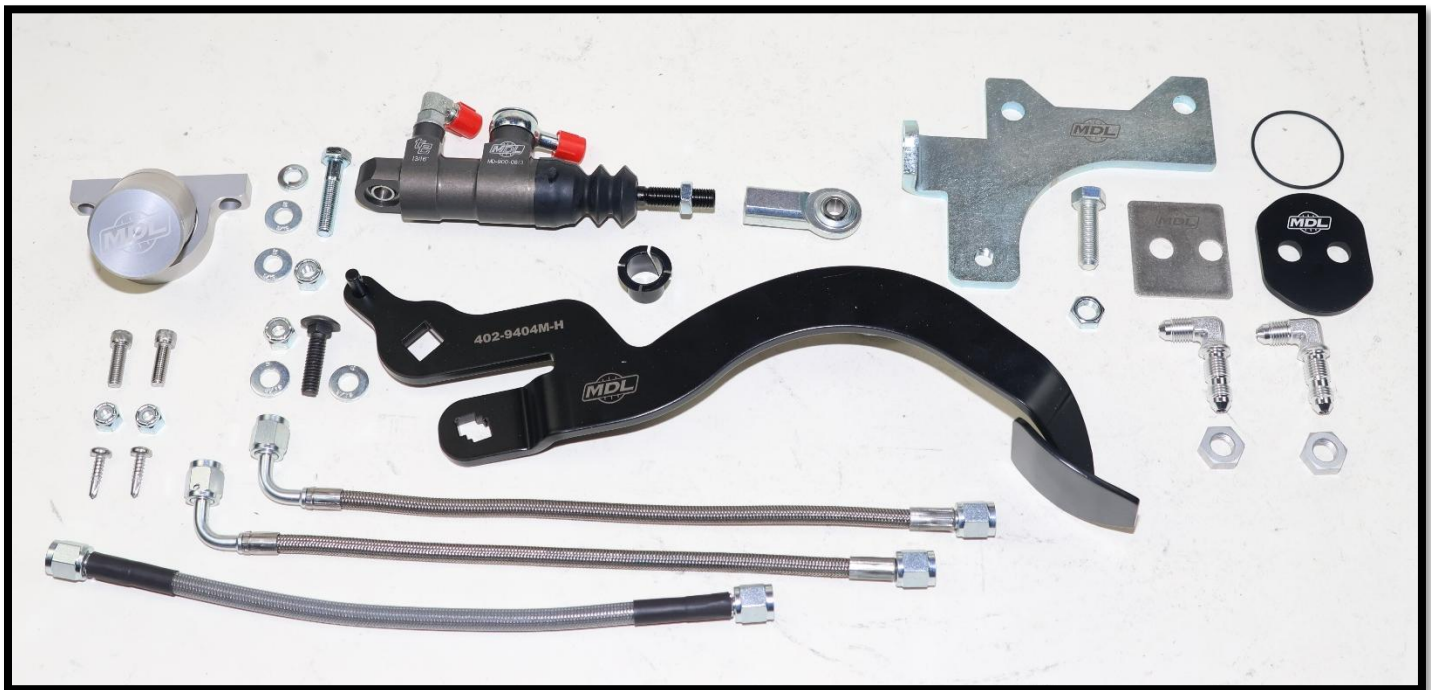

MAKE IT MODERN!
Five & Six Speed Conversion Specialists!

Stealth Series Master Cylinder Kit for 94-04 Mustang MD-910-3007-B and MD-910-3007-C

Installation Instructions



MD-910-3007-C kit shown

Thank you for purchasing the Modern Driveline *Stealth Series* Master Cylinder Kit. This kit is designed to attach to the **existing manual transmission pedal hangar**, leaving only the small premium billet reservoir exposed in the engine compartment for servicing and aesthetic appeal. Braided lines and bulkhead fittings seal the deal on this one!

Modern Driveline Stealth Series... This Kit is Out of Sight!

Read These Instructions Completely Before Beginning

1. Before You Begin

- 1.1. This kit will require some disassembly of the vehicle to install.
- 1.2. General vehicle mechanical knowledge and an understanding of the terminology are required to install this kit.
- 1.3. **DO NOT VACUUM OR PUMP BLEED THIS SYSTEM.** It is not brakes. Single seal push-pull systems will create micro bubbles in the fluid and in some instances harm the seals internally. The preferred method is to pressure bleed from the top down. Modern Driveline offers a hydraulic clutch system “bleeder kit”. The bleeder kit comes standard in all Modern Driveline master cylinder kits and is also available separately as a purchase item.
- 1.4. These systems are DOT 3 or DOT 4 brake fluid compatible. Do not use DOT 5 silicone based, or any high temperature resistant brake fluids designed for more than 550°F as some brands will cause the seals to swell.
- 1.5. This kit does not support automatic conversion vehicles.

2. Pedal Height Matters

- 2.1. Our Master kit has 3 adjustable positions for fine-tune adjustments. It is always recommended the pedal uses full-travel: Up-stop, down to carpet/floor. This will prevent damage to the cylinder.
- 2.2. All parts in this kit are designed with nominal clutch pedal height in mind. The ideal clutch pedal position will re-engage the clutch about 1/3 to 1/2 total pedal travel, up from the carpet.
- 2.3. It is not necessary for this master cylinder to use all the travel of the piston to release the clutch.

3. Information about this kit

- 3.1 This cylinder can travel **up to** 1.25”. Most installations will not use all the travel of this cylinder.
- 3.2 This cylinder has a 0.812” bore.
- 3.3 .812” bore x 1” stroke = .52 cu/in fluid volume requirement.
- 3.4 .812” bore x 1.2” stroke = .62 cu/in fluid volume requirement.
- 3.5 The existing aftermarket slave cylinders typically use 0.52” cu/in fluid volume and are considered compatible with this master cylinder kit.
- 3.6 Our mock-up firewall has certain items removed for clarity.
- 3.7 Three braided lines are provided in this kit. The coated line is for the reservoir. The two uncoated lines are for under the dash; This allows for greater flexibility.
- 3.8 If installed... the black ends on the coated line may be removed.
- 3.9 **No kit substitutions.** Additional or different parts may be purchased if you choose.
- 3.10 **Do not remove** the **red baffle** inside the reservoir.

4. **NON-Warrantable Conditions.**

- 4.1. Do not over-torque parts.
- 4.2. Do not over-tighten parts (non-torque valued locations).
- 4.3. Do not add parts to our kit.
- 4.4. Use all parts of this kit unless instructions are provided not to do so.
- 4.5. Do not substitute parts in this kit, contact MDL for assistance if necessary.
- 4.6. Required vehicle components are your responsibility.
- 4.7. Always check/test threads prior to installation into the vehicle. **Damaged threads are not warrantable.**

5. Tools, Shop Supplies, and Notes

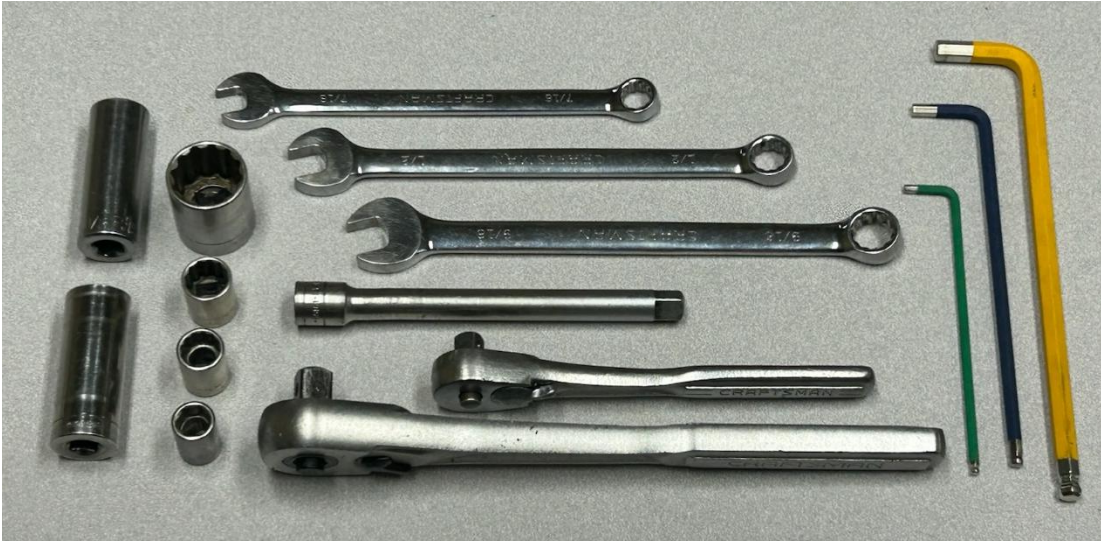

- 5.1. Standard shop tools, 1/8", 3/16", and 5/16" Allen Wrench, 11/16" & 3/4" Deep Sockets, 5/16"-24 tap, small vice-grips, hack saw blade.
- 5.2. Aluminum AN Fitting Wrenches (optional) for bulkhead fittings.
- 5.3. DOT 3 brake fluid.
- 5.4. Dielectric grease (typically used on spark plug wires).
- 5.5. Medium strength loc-tite (blue).
- 5.6. Soapy water in a spray bottle (brake fluid clean-up).
- 5.7. Safety Equipment – Always wear ANSI approved safety goggles/glasses when working with metal and fluids. Wear proper gloves when working with hot surfaces and corrosive fluids.
- 5.8. A ground strap from the engine to the body, and body to frame, must be used.

Failure to install a ground strap from the engine to the body and frame will result in braided line failure. The braided line cannot be used as a ground strap.

6. Provisional Parts – Some parts may not be required depending on pedal hangar and brake pedal configuration.

- 6.1. MDL provides (1) new pedal shaft bushing in this kit for the clutch pedal cross shaft at the outboard end only. You do not have to use this part if your cross-shaft bushing is good at this location. The instructions do not task you to remove the pedal hangar from the vehicle.

7. Options

- 7.1. Alternate routing of braided lines and firewall bulkhead fitting location may be used for customized firewalls. Consider reservoir placement on firewall. This kit provides parts for a factory firewall installation. Optional items may be purchased separately. No kit substitutions.
- 7.2. MDL offers a spacer that can be used for the reservoir bracket, typically used under the lip of the cowl. This billet aluminum part is anodized in clear or black to match the reservoirs. It is not a part of this kit but is available for purchase. It comes with two different styles of mounting hardware. Reference part number MD-960-2004-B or MD-960-2004-C.

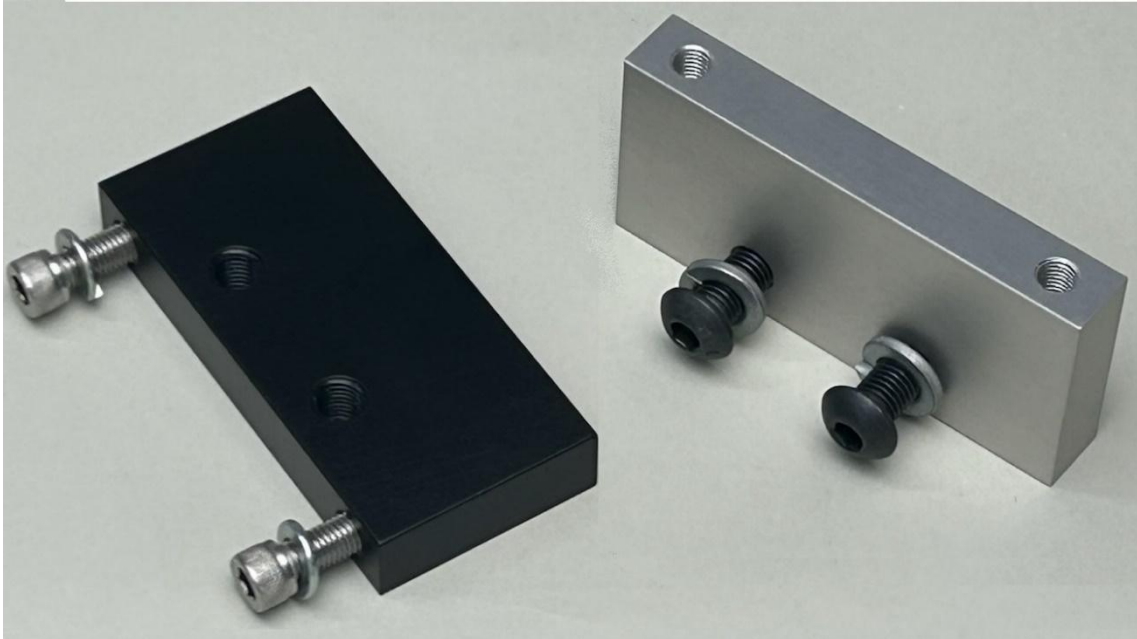

Optional spacers come with 1/4"-28 and 5/16"-24 Socket head fasteners and lock washers. 5/16" top-mount, and 1/4" through-mount. Requires 1/8" Allen wrench. Anti-seize lubricant recommended.

8. Disassembly – If your Vehicle is already disassembled, skip to the Assembly Instructions. Disconnect the battery cable, jack up the vehicle for access, use wheel chock and jack stands as applicable.
 - 8.1. Remove the driver's seat and lay down some cardboard.
 - 8.2. Removal of the pedal hangar assembly from the vehicle is not necessary.
 - 8.3. Remove the clutch cable assembly - Have a second person firmly lift-up on the clutch pedal until it stops and hold in this position. The first person will remove the cable cover from the bell housing and push the clutch lever towards the rear of the vehicle and using a small pair of vice grips, clamp the cable where it exits the cable housing. Pull the fork forward and release the cable end from the clutch lever. The second person will push upward on the large plastic gear attached to the pedal under the dash. The first person will release vise-grips and push the cable into the cable housing. The second person will remove the cable end from the large plastic gear. Release parts and remove the retention clip & fasteners on the firewall, bell, & frame, remove cable from vehicle.

8.4. *** Be careful not to damage the neutral start switch *** Remove (2) hair-pin clips, gears and springs from the clutch pedal arm, these parts will not be re-used. Remove the big gear first, see pictures below. The small gear will be cut with a hack saw blade from the engine compartment. Wrap the held end with duct tape to protect yourself and cut next to the spring. Remove small gear and spring.

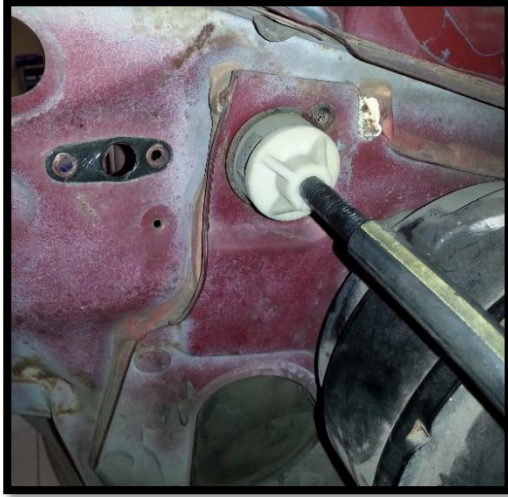

Cable installed

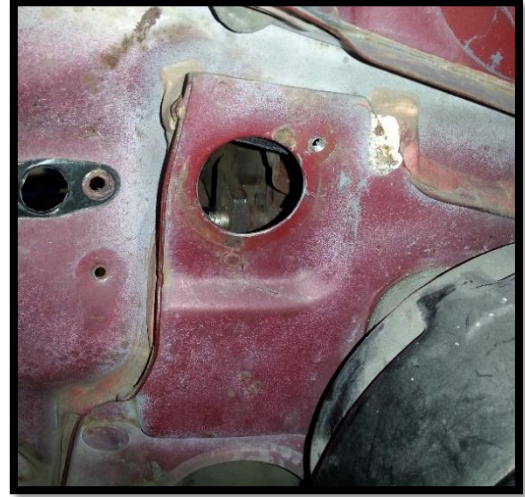

Cable removed

8.5. Remove the cruise control cut-off switch using a 10mm wrench. Take your time... this can be done with your right hand only.



Cruise Control cut-off switch

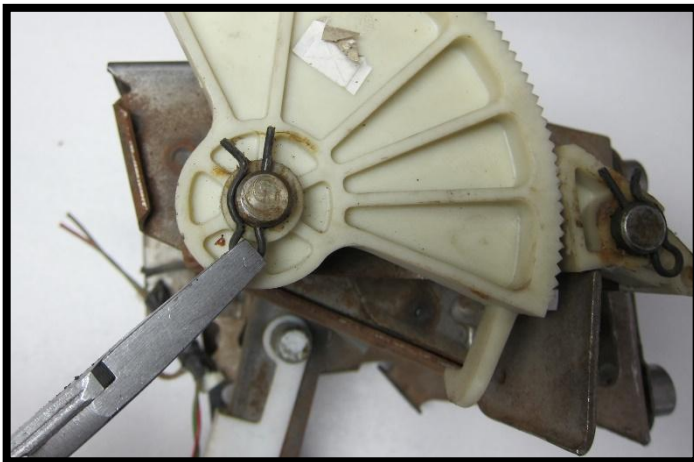

Use pliers or hook tool to remove clip. Push a screwdriver up between pedal arm and spring; it will spring loose and come off easily.

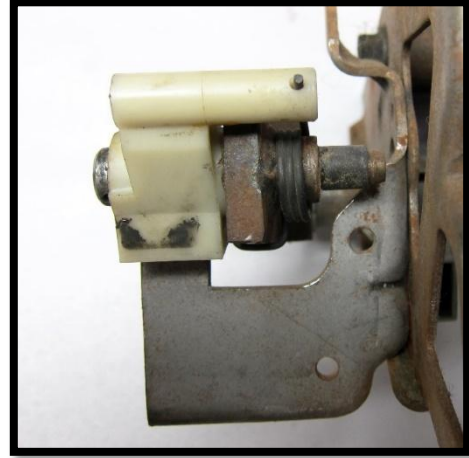

Use a long skinny screwdriver to pry spring from arm. Cut plastic gear from engine compartment.

- 8.6. Remove the hair pin clip and 7mm bolt for the neutral start switch, forward of the clutch pedal, and lay the switch (with wires connected) out of the way.
- 8.7. Remove the factory clutch pedal from the cross shaft. This is also a metric nut.
- 8.8. Remove two nuts from brake booster studs at the location shown below.

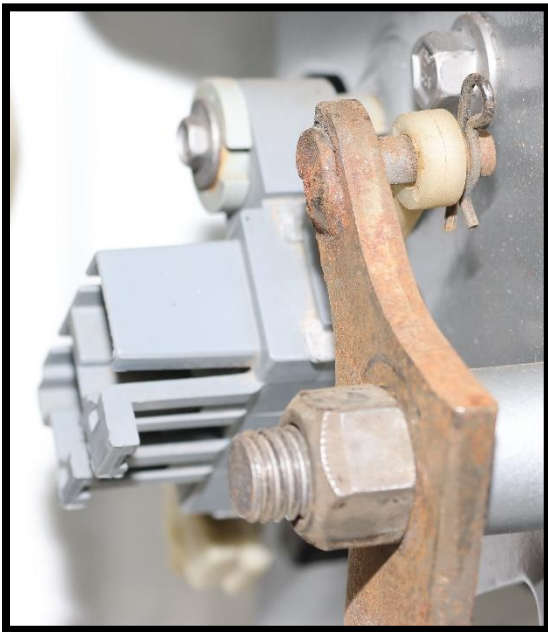

Remove this start switch and retaining hardware.

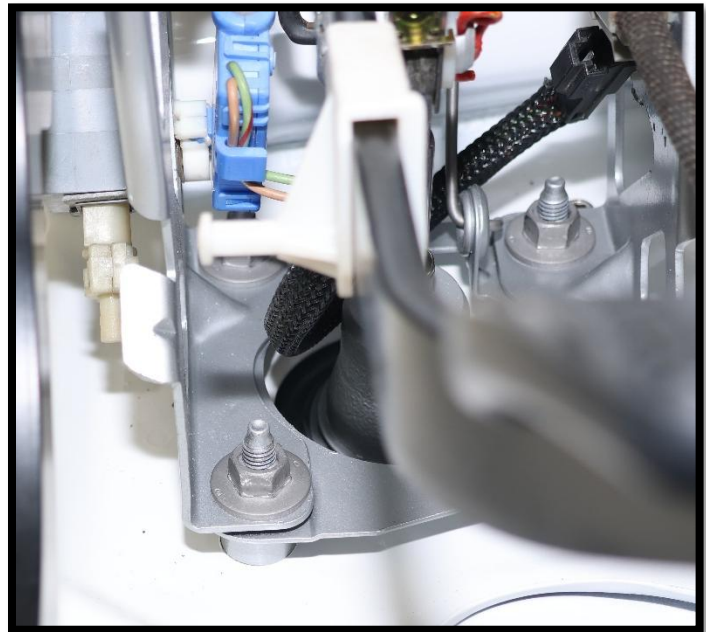

Remove two lower pedal hanger nuts. L/H lower shown.

9. **Installation** - Clean as you go, use soapy water on spilled brake fluid, general cleanliness for all fitting and line-end ports. **Note: For convenience of installation, you may work out of sequence.**

- 9.1. Install MDL supplied Pedal Hangar Bracket on the pedal hangar using existing studs and nuts. Tighten nuts wrist tight.
- 9.2. Install new supplied pedal bushing if required.
- 9.3. Position the clutch pedal with the carriage bolt. The carriage bolt & nut is not easy to get to once the pedal is installed.

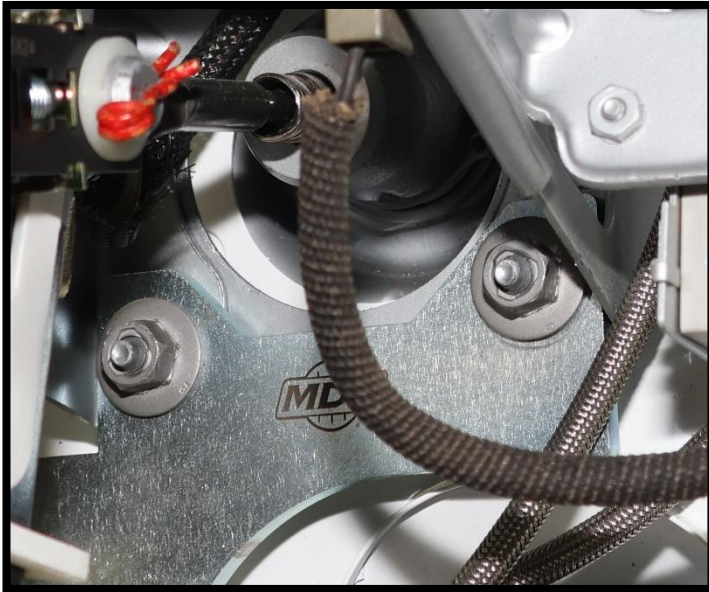

Bracket shown installed on booster studs.



Pedal with carriage bolt and nut.

9.4. Torque the existing pedal nut to 35 ft lbs, light elbow tight.

9.5. Re-install the neutral start switch with bolt and hairpin clip. Do not overtighten the nut.

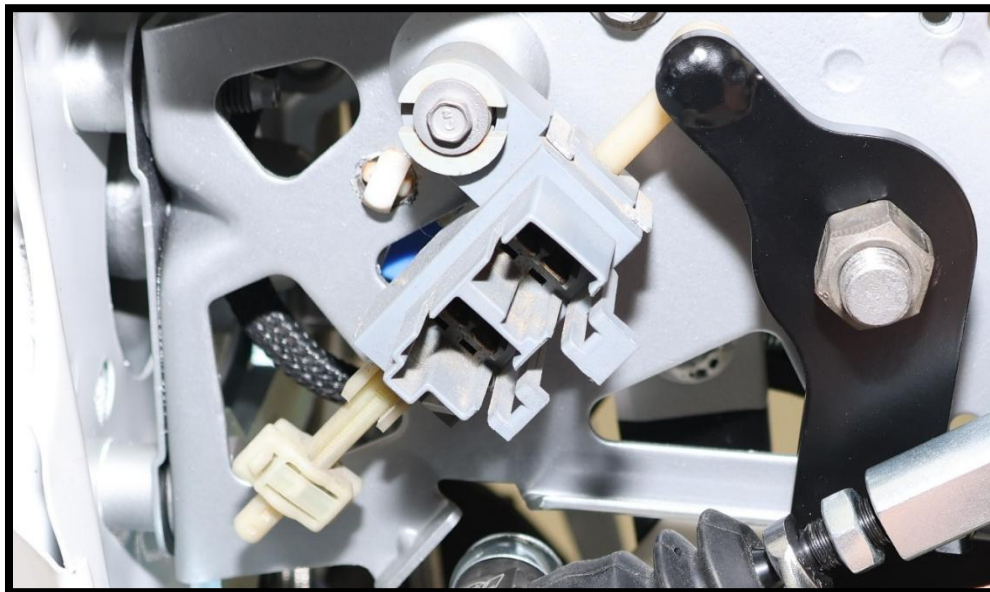

MDL Clutch pedal with carriage bolt/nut, and neutral start switch.

- 9.6. Re-install the cruise control cut-off switch previously removed in these instructions.
- 9.7. Verify the pedal swings freely from the carpet, up to the cruise control shut-off switch located on the opposite side of the cross-shaft.
- 9.8. See below picture. Install the rod-end on the master cylinder (the jamb nut should already be installed) but do not torque or tighten at this time. Adjust to 7" to the center of the bearings.



- 9.9. There are 3 positions on the clutch pedal the rod-end can be attached to. Position the carriage bolt through the center of the 3 positions on the pedal. There are Adjustment Instructions provided at the end. Be sure the carriage bolt catches the indentations on the pedal correctly and hold in position. Attach the rod-end to the pedal. The order of washer stack-up is very important.

M/C at pedal - from *inboard to outboard*... carriage bolt, pedal, flat washer, rod-end, nylok nut.

- 9.10. Torque the bolt/nut at this locations to 15-18 ft/lbs, light wrist tight.



Carriage bold centered



Rod-end being installed

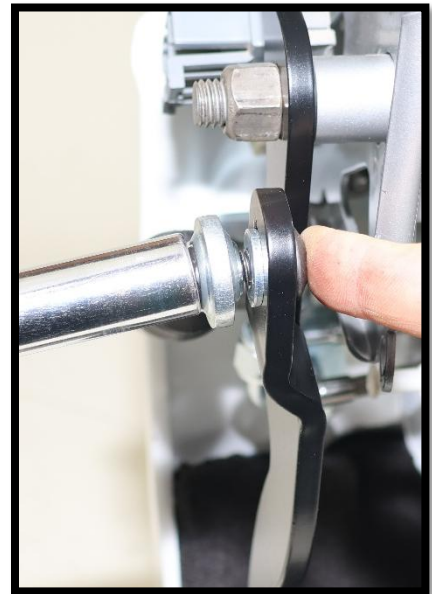

Socket on nut

- 9.11. Attach master cylinder to the bracket. The order of washer stack-up is very important. M/C at bracket - from *inboard to outboard*... bolt head, bracket, (2) flat washers, Cylinder, lock washer, nylok nut. Position any extra washers between the lock washer and nylok nut.
- 9.12. Torque the bolt/nut at this locations to 15-18 ft/lbs, light wrist tight.



- 9.13. Install (1) 3/8" bolt with jamb nut into the bracket. Thread the 3/8" bolt into the bracket until the bolt contacts the firewall then add an additional 1/2 turn and tighten jamb nut against the bracket using 9/16" wrenches wrist tight.



- 9.14. Cycle the clutch pedal **by hand** and check for freedom of movement. There should not be any binding and the pedal stroke freely. The rod inside the cylinder may be rotated using the two flat spots on the rod and a 5/16" wrench, or the rod may be rotated by hand; The rod will have some resistance.

DO NOT PRELOAD THE MASTER CYLINDER ROD; doing so will not allow you to bleed the system. Rotate the master cylinder rod as needed so the pedal has compressed the cruise control cut-off switch and tighten the jamb nut against the rod-end, light wrist tight. Do not bottom out on the cruise control cut-off switch.



- 9.15. Re-check for freedom of movement. The pedal should stroke completely to the floor and come up about 1" above the brake pedal.
- 9.16. Position the master cylinder fittings approximately as shown. The banjo fitting is the reservoir port, and the small elbow fitting is the pressure port. Do not completely torque the banjo fitting at this time but do not leave loose. The lines at the firewall can be swapped for position depending on how you would like the engine compartment side to appear. Pre-assemble the lines as shown. Do not tighten either line to the 90 degree bulkhead fittings; clocking will need to be performed.



- 9.17. The firewall plate assembly is not reversible. The O-ring will always install on the black half in the engine compartment. Prior to installing the O-ring... verify the step on the black plate fits in the clutch cable hole and the opening in the firewall is flat. Use a round edge file to clean up the opening as necessary. Apply a small amount of dielectric grease to hold the O-ring in place. Position the inner and outer firewall plates with both bulkhead elbow fittings and lines. **The elbow ends go under the dash.** Lightly secure the elbow fittings in the firewall plates.



Some assembly sequencing can vary based on tool availability.

- 9.18. Torque the pressure line-end to elbow fitting at the firewall to 25 ft/lbs, wrist tight.
- 9.19. Holding the pressure line elbow fitting with a 7/16" wrench under the dash, torque the jamb nut in the engine compartment 12 to 15 ft/lbs, light wrist tight, using an 11/16" or 3/4" socket.
- 9.20. Torque the pressure port fitting in the master cylinder to 15 ft/lbs, light wrist tight. This step may already be complete.
- 9.21. Torque the line-end to the pressure port on the master cylinder to 25 ft/lbs, wrist tight. Be sure to hold the fitting while tightening the line-end.
- 9.22. Torque the reservoir line-end to the banjo fitting to 25 ft/lbs, wrist tight.
- 9.23. Hold the line-end and banjo fitting by hand and tighten the 5/16" Allen head banjo fitting wrist tight.
- 9.24. Install/attach the second elbow fitting in the firewall, snugging up the jamb nut, and torque the reservoir line-ends to 25 ft/lbs.
- 9.25. Holding the elbow fitting with a 7/16" wrench under the dash, torque the jamb nut in the engine compartment 12 to 15 ft/lbs, light wrist tight, using an 11/16" or 3/4" socket.

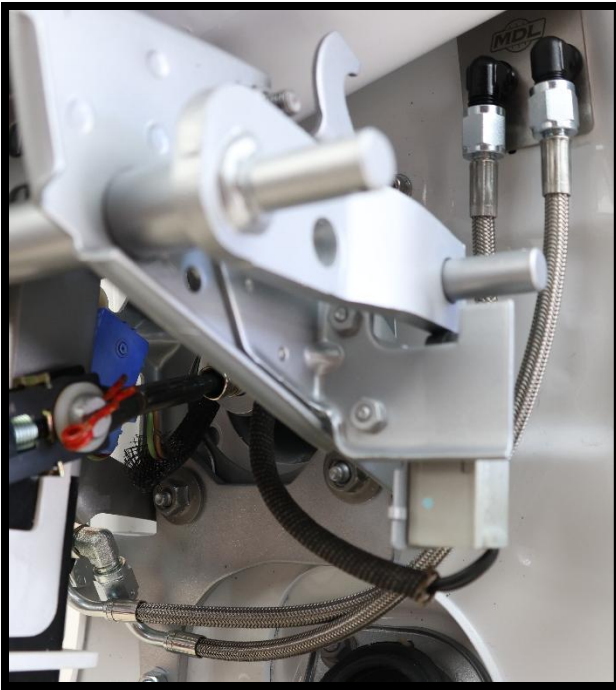

Completed installation of parts under the dash. Route hoses approximately as shown.

9.26. Cycle the clutch pedal **by hand** and check for freedom of movement. All fittings and hardware should be tight. Double-check the installation for any loose connections that may have been missed.

Finish the installation by mounting the reservoir and clamp assembly on the firewall or bracket of your choosing. It is important the reservoir line in the engine compartment be attached to the matching fitting for the reservoir port under the dash. Use the self-tapping screws or the bolt/nut combination to mount the clamp. The clamp can slide up and down the reservoir body to a location of your choosing.



9.27. Thread the 12" braided line onto the bottom of the reservoir and the bulkhead fitting. Locate the reservoir for appearance and convenience of servicing.

- 9.28. Mark the location on the firewall for fasteners.
- 9.29. Tighten the clamp to body at the desired height using 1/8" Allen wrench.
- 9.30. Hold the elbow fitting with a 7/16" wrench under the dash, torque the line-end to 25 ft/lbs, wrist tight.
- 9.31. Torque the line-end to the reservoir 15-25 ft/lbs, wrist tight. Watch for reservoir body slipping in clamp.



Black billet reservoir shown with optional block billet spacer, mounted through the firewall.

- 9.32. At this point the installation of the Stealth master cylinder system is complete. You will be left with a single AN4 open port for the line going to the slave cylinder of choice. The same instructions must be performed for attaching the braided line to the bulkhead fitting. Use the supplied **red threaded cap** to cover the open port. The **red threaded plug** is not used but supplied for your convenience.
- 9.33. Re-assemble your vehicle at the dash to include the instrument cluster and steering column, if removed. Verify there is no interference of electrical wire or ducting to the Stealth system.
- 9.34. Remove the cardboard, re-install the seat, and re-connect the battery as required.
10. **Bleeding the System**
- 10.1. In the master cylinder kit is a Bleeder Kit. Follow the *bleeder kit* instructions. If you have lost the bleeder kit instructions, they can be found on our web site modern driveline.com.
Note: The RED BAFFLE in the reservoir is not a bladder, do not remove it.
You may take the red baffle out temporarily to perform the bleed operations but do not actuate the system without the red baffle and reservoir cap re-installed. Brake fluid will spill.

11. Driveway Test and Test Drive

- 11.1. Position rear wheels on jack stands (free to rotate). With transmission in neutral, start vehicle. Push in clutch pedal and apply brake pressure. Transmission should go into 1st gear easily. Slowly release clutch pedal. Pedal should start to engage the clutch at a comfortable level of the pedal travel (about 1.0"-1.5" from floor). **It is okay if the clutch pedal releases close to the floor while on jack stands. It will release higher when the vehicle is on the ground.** A new or rebuilt transmission should have all the gears run through (in the driveway, partially releasing clutch) before road testing the new hydraulic clutch.
- 11.2. Remove jack stands and test drive. Upon return, verify steel braided line clearance and support. The hydraulic lines must be kept away from the exhaust and rotating clutch assembly.
- 11.3. If the clutch feels spongy or releases too close to the floor, repeat the bleed procedure. FYI – micro bubbles may be present in the system due to actuation, accumulation on rubber parts, and machining marks within the system.

12. Reminders

- 12.1. **DO NOT VACUUM OR PUMP BLEED THIS SYSTEM.**
- 12.2. Important: Once your new hydraulic system is active, the pedal will be immediately firm. It should not feel spongy or soft. Lack of immediate movement or a spongy feeling clutch pedal indicates air is still in the system.
- 12.3. Periodic adjustment is **not** required for this master cylinder system. The goal is for the clutch to re-engage in the bottom 1/3 to 1/2 of clutch pedal travel, otherwise, over-travel may occur. Once again, make sure the slave cylinder of choice is set up correctly.

13. Adjustments

- 13.1. Once you have confirmed all the air is out of the system it is time to discuss your adjustment options. NEVER do the below steps on jack stands; The behavior of clutch release is much different under driving conditions. Use the instructions above to make changes.
- 13.2. **If the pedal is re-engaging too high** up from the floor, move the rod-end attach location on the clutch pedal to the hole closest to the pivot (cross shaft). This will also make the pedal pressure a little softer.
- 13.3. **If the pedal is releasing too close to the floor**, or if you want assured release for racing applications, move the rod-end attach location on the clutch pedal to the hole furthest from the pivot (cross shaft). This will also make the pedal pressure a little firmer.

Note: over-stroking a slave cylinder may occur so use a volume calculator to prevent component damage. A pedal stop may also be required to prevent damage to components. Always test the stroke of the pedal and set stops accordingly.

Further assistance and tech support is available by calling Modern Driveline at 208-453-9800 M-F 8-5 Mountain time. Email – Tech@ModernDriveline.com . Please contact us first for any issues.

Enjoy your new hydraulic system and Thank You for choosing Modern Driveline.
We appreciate your business.

| ITEM NO. | DESCRIPTION | QTY. |
|----------|--|------|
| 1 | Stealth clutch pedal, 94-04 SN95 Mustang | 1 |
| 2 | Tilton Master Cylinder with fittings | 1 |
| 3 | Stealth bracket, 94-04 Mustang | 1 |
| 4 | 5/16" flat washer | 4 |
| 5 | Lock Nut-5/16-24 nylock | 1 |
| 6 | 5/16-24 x 1.5 Hex Bolt | 1 |
| 7 | Lockwasher, 5/16" | 1 |
| 8 | Bolt, Hex, 3/8-24 x 1.25 | 1 |
| 9 | Nut, hex, 3/8-24 | 1 |
| 10 | Ball Joint Rod End | 1 |
| 11 | Carriage bolt, 5/16-18 x 1.25 LG | 1 |
| 12 | 5/16-18 Nylon Lock Nut | 1 |
| 13 | Plug, AN4, LDPE, 7/16-20 | 1 |
| 14 | 12" uncoated braided line AN4 F-90F | 2 |
| 15 | 79-04 Mustang Bulkhead Plate Assembly, 2" Oval 2-Hole, for AN4 | 1 |
| 16 | Reservoir, Clutch, Billet Aluminum | 1 |
| 17 | AN 37 degree flared 90 deg fitting | 2 |
| 18 | Bushing-Clutch Pedal Shaft | 1 |

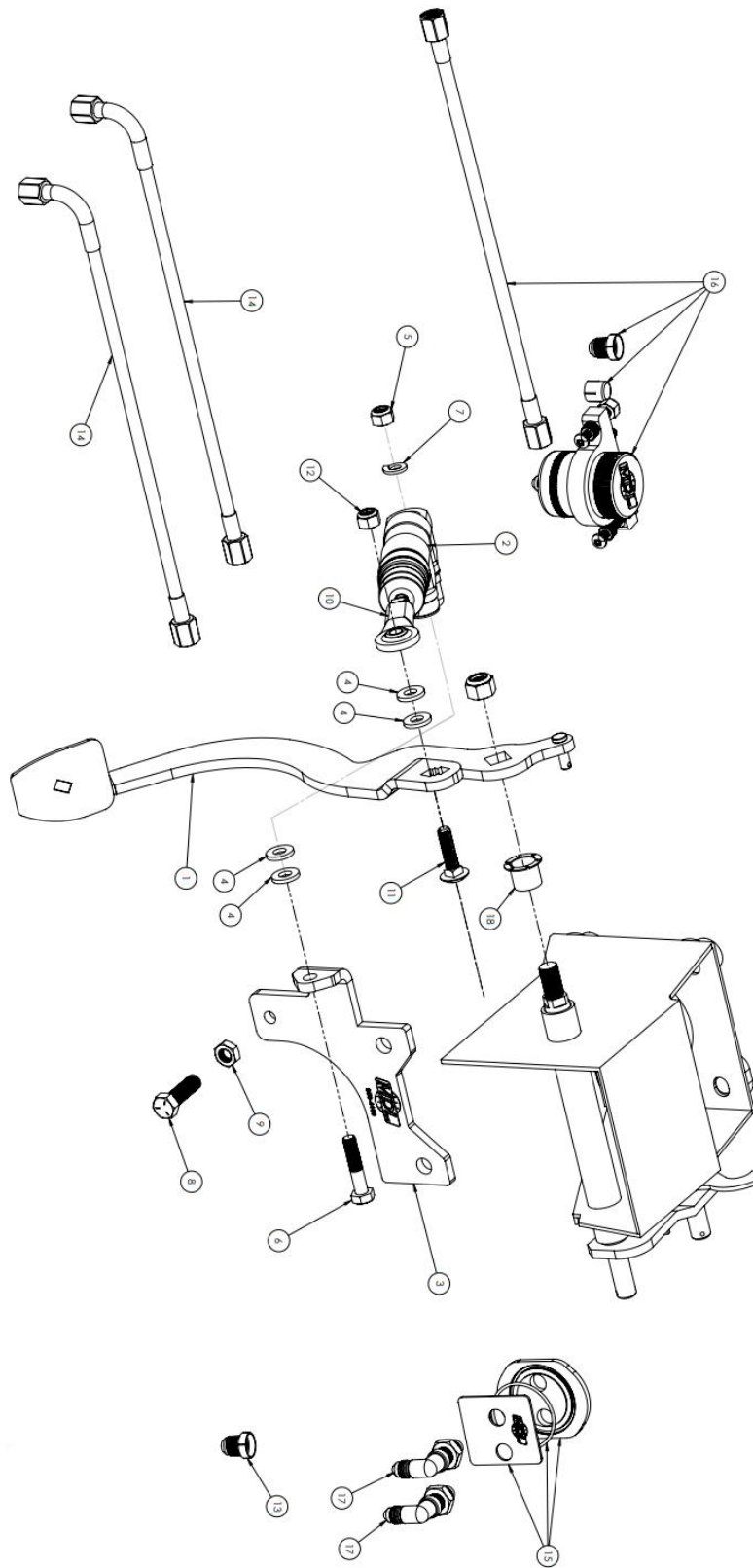

5/16" flat washers, #4, are variable at each mounting location.