

MM K-Member, 1996-04 (MMKM-2)



Read all instructions before beginning work. Following instructions in the proper sequence will ensure the best and easiest installation.

Thank you for purchasing the Maximum Motorsports K-member. The MM K-member is designed to maximize the performance of your Mustang's front suspension. You will find many features that set the MM K-member apart from the rest.

- There are two sets of control arm mounting holes—that means the roll center height and camber curves can be optimized for your car's ride height.
- The Ackerman steering geometry is adjustable and optimized.
- The front track is widened by 0.1" per side. This provides a wider stance for better cornering.
- The wheelbase is lengthened by 0.75", whereby front-to-rear weight distribution is improved by 1%. Caster is increased by 2 degrees for improved cornering grip, tire wear, and high-speed stability.
- The MM K-Member maintains the stock percentage of anti-dive geometry. Our testing has proven that increased anti-dive will hurt the car's ability to absorb bumps during braking. Any less anti-dive will cause excessive pitching during braking.
- The K-member is the load path into the chassis for all front wheel steering, cornering, and braking forces—it must be engineered for strength and stiffness. This is a fully triangulated design, using round or rectangular tubing where each is appropriate, and shear planes where necessary. This robust design is intended to last the life of your vehicle, providing maximum return on your investment.

- Of all the K-members available, MM's is the most rigid, and yet our testing has shown that a K-member brace is still required. We include a K-member brace with the K-member to ensure maximum suspension rigidity during cornering.
- The MM K-member provides increased clearance for engine and suspension service, and over 1" greater header clearance in critical areas. This provides much needed access to header bolts.

Proper installation of the MM K-member will require use of the following parts:

- Tubular Front Control Arms
- Front Coil-Over Conversion Kit
- Caster/Camber Plates (coil-over compatible)
- MMST-6 Spherical Rack Bushing Kit
- Adjustable Tie-Rod End Kit
- Front Swaybar Relocation Kit (when using the forward-offset control arms)
- Modular Engine Oil Filter Relocation Kit (for all Modular DOHC and SOHC engines with OEM oil coolers)

We recommend the following parts to accompany the installation of the MM K-member:

- Solid steering shaft
- Shorter aftermarket urethane swaybar end links
- Strut Tower Brace
- High performance struts to match coil over spring rates

Tools required

- 2 large C-clamps
- 4 jack stands
- Bumpsteer gauge
- Engine hoist or support beam
- Floor jack
- Masking tape & Pen
- Plumb bob(s)
- Spring compressor (internal type)
- Tape measure
- Torque wrench
- T-55 Torx Socket
- Female Torx socket set
- Typical selection of hand tools

Modular Engine Oil Filter Relocation

4V Cobra engines and '96-'98 GT cars with automatic transmissions are typically equipped with a large oil cooler under the oil filter. Occasionally cars outside this category will have an oil cooler as well. Cars with an oil cooler require installation of an oil filter relocation kit (MMOC-3 or MMOC-4). Relocation of the oil filter provides required clearance for the MM K-member.

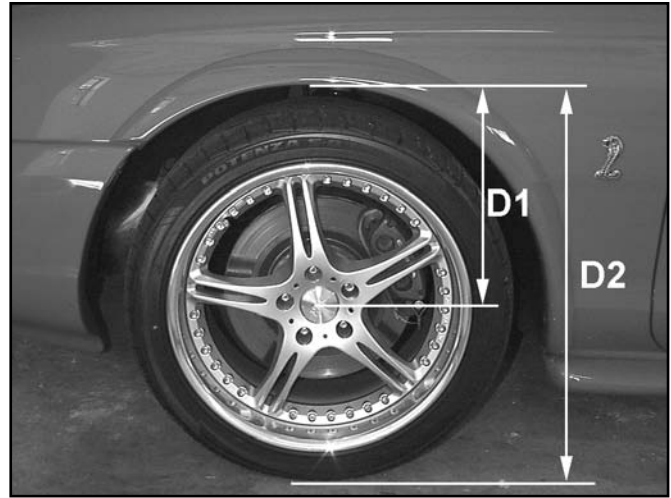
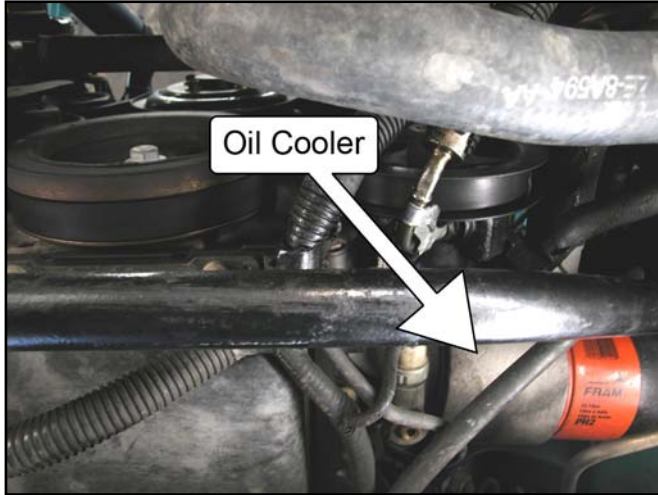

4. Jack up the car and place it safely on four jack stands as high as possible. Two jack stands should be placed under the front subframe, between the radiator support and the front sway bar mount. The other two jack stands should be placed under the rear axle or IRS subframe.

Bumpsteer and Ackerman Steering

Installation of the MM K-member requires the use of an adjustable tie-rod kit (MMTR-3). This kit relocates the outer tie rod end pivots in order to minimize bumpsteer with the revised front suspension geometry of the MM K-member.

MM requires the use of the MMST-6 Spherical Rack Bushings to position the rack as high as possible. This minimizes the offset of the tie rod end below the steering arm of the spindle.

Swaybar Location

If the MM non-offset front control arms are used, the front swaybar can remain mounted in the stock location. If the MM forward-offset front control arms are used, the front swaybar must be mounted with the MM Front Swaybar Relocation Kit (MMFSB-51). The relocation kit moves the swaybar forward 1" to compensate for the more forward location of the swaybar mounting hole with the MM forward-offset control arms.



Stock K-Member Removal

1. Position the vehicle on a flat, level surface.
2. Disconnect the ground terminal at the battery.
3. Measure the vertical distance from the center of the front wheel to the fender lip. Record this dimension as D1. Also measure from the ground to the front fender lip. Record this dimension as D2. These dimensions will be needed later.

5. Level the car by measuring from the bottom of the rocker panels to the ground. Adjust the height of the jack stands to get the car as level as possible.
6. The engine needs to be supported from above. There are two ways of accomplishing this. One is to use an engine hoist. The second is to use an engine support beam. Using an engine support beam makes the job much easier, because there will be more room under the car. Details for fabricating an engine support beam are attached at the end of these instructions.
7. If using an engine support beam as described in the attached fabrication instructions, the engine is supported by the alternator mounting bolts. Removal of the alternator may be necessary. Removing the alternator may require removal of certain underdrive water pump pulleys and the strut tower brace. Place the engine support beam across the inner fenders and position each of the eyelet bolts where they can be attached to the engine.



8. Remove the front wheels.
9. Remove the front caliper and hang it securely. Do not let the caliper hang from the brake hoses, as this can cause unseen damage to the hose. Steel braided hoses are especially susceptible to damage if the caliper is dropped or allowed to hang unsupported.



10. Remove the front brake rotor.
11. Detach the ABS sensor from the spindle.
12. Loosen, but do not remove, the two strut-to-spindle bolts.

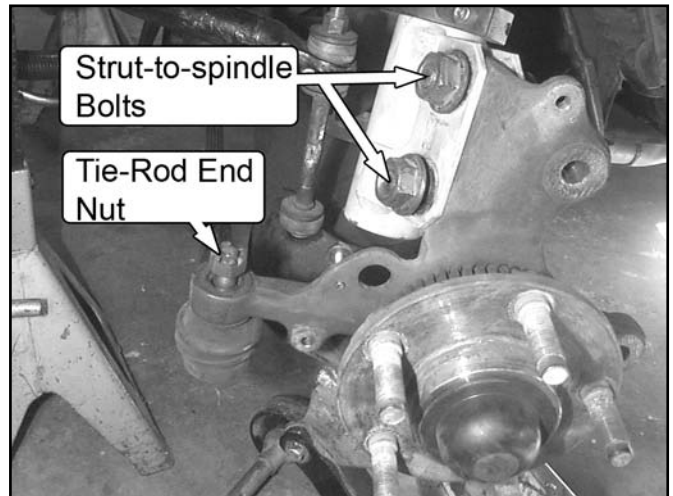

13. Loosen, but do not remove, the tie-rod end nut that retains the tie-rod end to the steering arm.
14. Spray the outer tie-rod end tapered stud with penetrating oil.
15. Detach the front swaybar end link from the control arm and from the swaybar.
16. Turn the spindle to its maximum toe-in position. Place a floor jack under the control arm near the ball joint. Leave about 1/2" of clearance between the floor jack and the control arm.

17. Loosen the ball joint nut until the top of the nut is flush with the top of the ball joint stud.

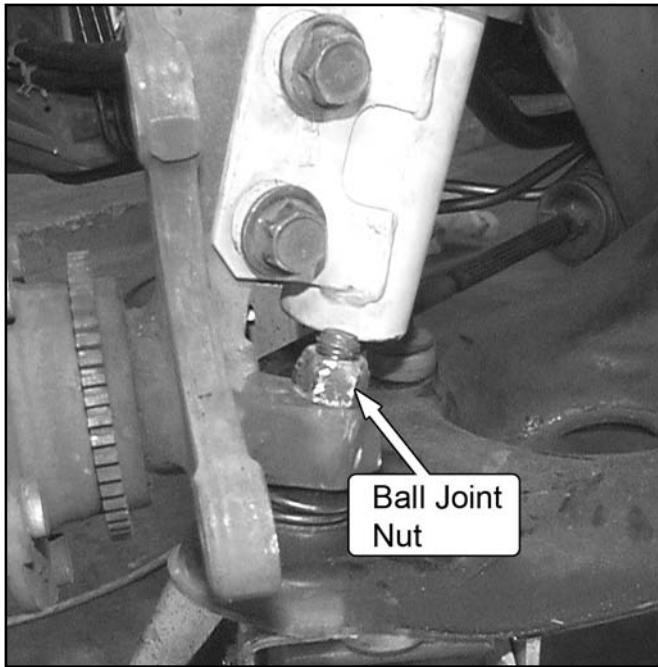

18. Spray the ball joint taper with penetrating oil.

19. Free the tie-rod end by hitting the front of the steering arm with a large hammer in the direction shown. Do this until the tie-rod end taper comes free from the steering arm.



20. Remove the nut from the tie-rod end and detach the tie-rod end from the steering arm.

21. Make sure the floor jack is still in place below the control arm. Strike the spindle with a large hammer just below the strut, where the ball joint attaches to the spindle. Do this until the ball joint taper comes free from the spindle.

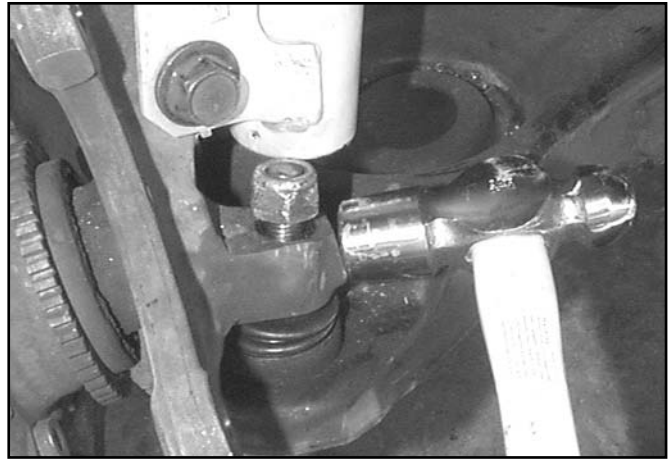

22. For cars equipped with conventional front coil springs, use an internally-mounted coil spring compressor and compress the front coil spring. Most auto part and equipment rental stores rent this type of spring compressor.

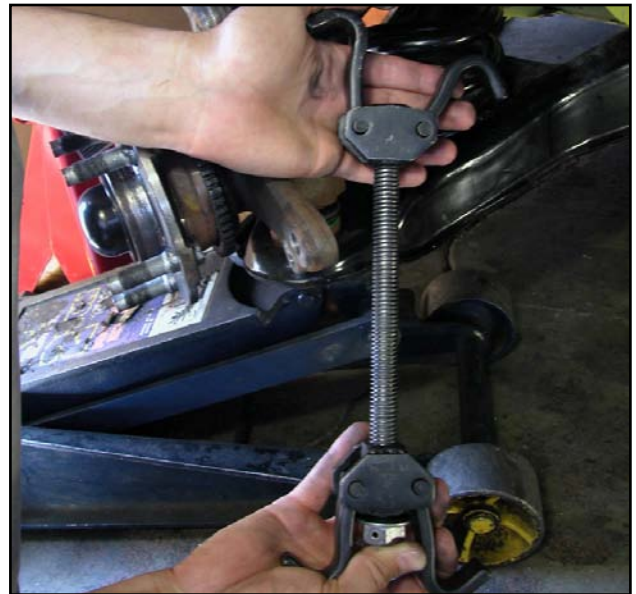

23. Raise the control arm 1/2" with the floor jack. Remove the ball joint nut completely.
24. Remove the strut-to-spindle bolts completely.
25. Remove the spindle.
26. For easier access, remove the strut top retaining nut and remove the strut from the car.
For cars equipped with coil-over conversions, skip to Step 29.
27. Carefully lower the floor jack until the front spring becomes unseated from the upper spring perch.
28. With the floor jack completely removed from under the control arm, release the internal spring compressor to free the spring from the control arm.
29. Repeat Steps 9-28 for the passenger side of the car.
30. Completely remove the pinch bolt that holds the steering shaft to the input shaft of the steering rack. Some factory K-members have an access hole which allows easier access to the pinch bolt.

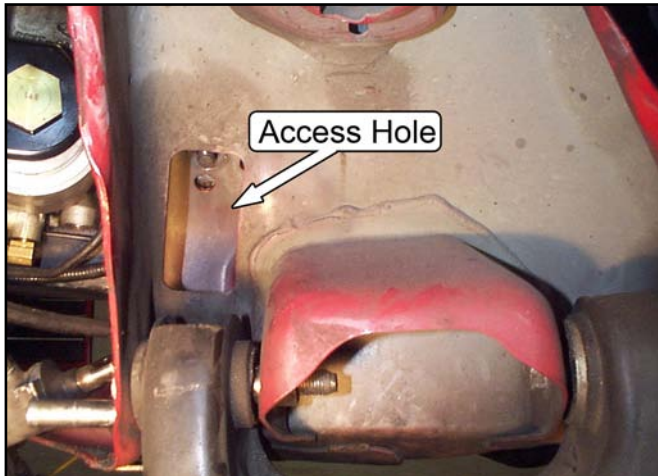

31. Remove the two bolts that hold the steering rack to the K-member. Pull the steering rack forward until it is just below the swaybar. To keep the steering rack out of the way, zip tie or wire it underneath the swaybar. It is not necessary to disconnect any hoses from the steering rack.

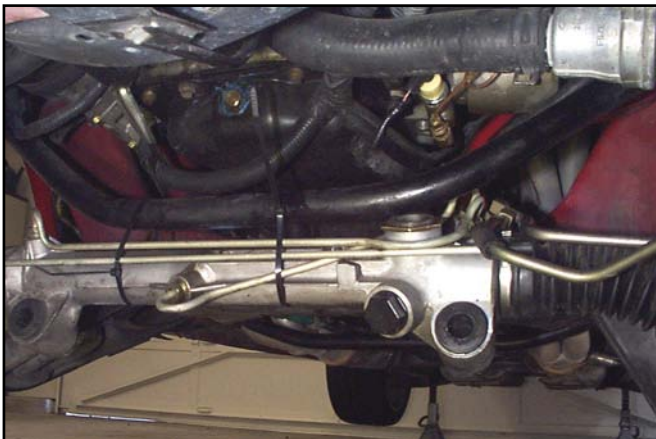

32. Remove each of the retaining nuts holding the motor mounts to the K-member. Each nut can be accessed via the respective access hole in the stock K-member.
33. Raise the engine about 1/2" with the engine hoist or the engine support beam. Raise the engine just far enough that the motor mounts do not touch the K-member. Disconnect any wires that may be attached to the K-member.
34. Place a wood board on the jack and raise the jack until the K-member is just supported on the wood board.

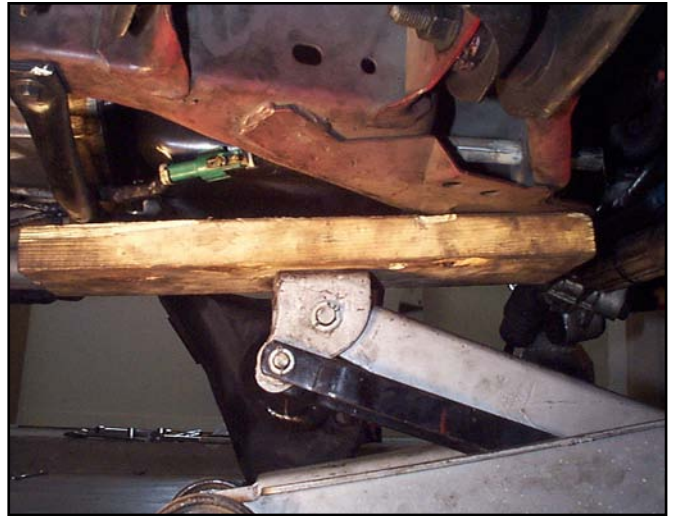

35. Loosen, but do not remove, the four bolts that hold the K-member to the frame near the upper spring pockets.

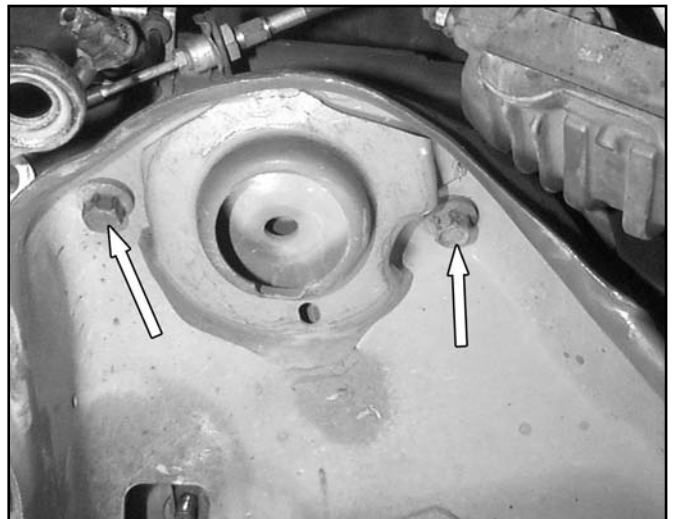

36. Remove the four bolts at the rear of the K-member.

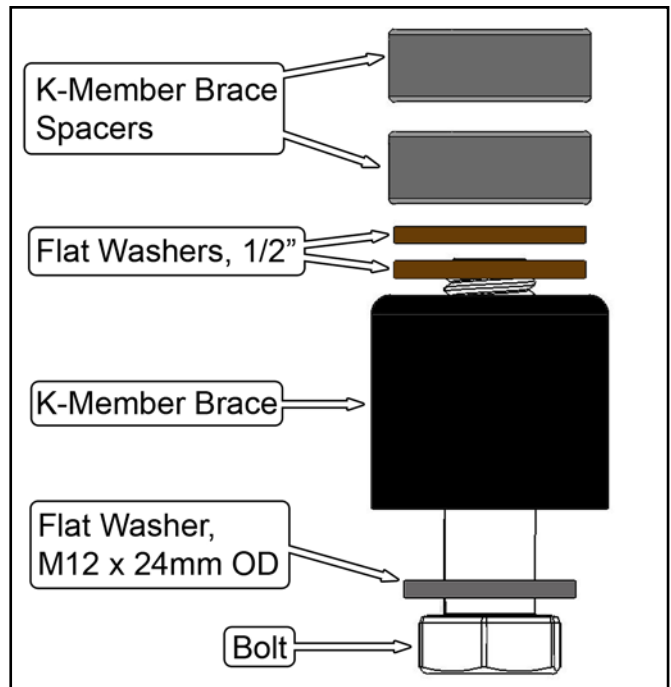
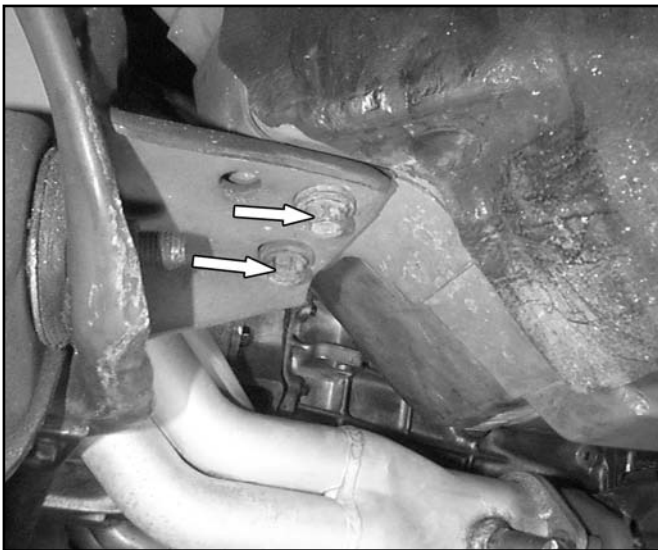

37. Remove the four upper K-member mounting bolts completely. Have a second person stabilize the K-member while doing this. Slowly lower the floor jack and K-member while also checking for any objects that may hang up on the K-member. Lower the K-member to the floor and remove it from underneath the car.

Now is an excellent time to clean off the bottom of the engine, replace that leaking oil pan gasket, or replace worn motor mounts.

MM K-Member Installation

38. Remove the ground strap from the driver side frame rail. The ground strap is located just rearward of the swaybar mount.
39. Attach the supplied MM K-member Brace to the MM K-member. Place one K-member Brace Spacer between each end of the brace and the k-member. Use the 1/2" X 1-1/4" G8 bolts with an M12 X 24mm OD washer under the head of each bolt to secure the brace. If you have long-tube headers, space the brace down as far as possible using the provided spacers, 1/2" Flat washers, and the 1/2" X 2" long bolts with an M12 x 24mm OD washer under the head of each bolt. Snug, but do not fully tighten the bolts. Orient the brace with the center section biased towards the rear of the car.

Note: Some installations may not require spacers. Your requirements may vary.



Note: Make sure there is about a 1/4" gap between the bellhousing and the MM K-member Brace.



40. Place the wood board on the floorjack and place the K-member on the wood board. The K-member should be located so that it is balanced on the center of the jack pad.
41. Slowly raise the K-member into position underneath the front of the vehicle. Guide the engine mount studs into the engine mount slots in the K-member. Check to make sure that nothing is getting pinched as you raise the K-member. There may be brake line interference on one or both sides of the car. The lines may be carefully bent, as needed, to provide required clearance. If necessary, trim the plastic fender liner.

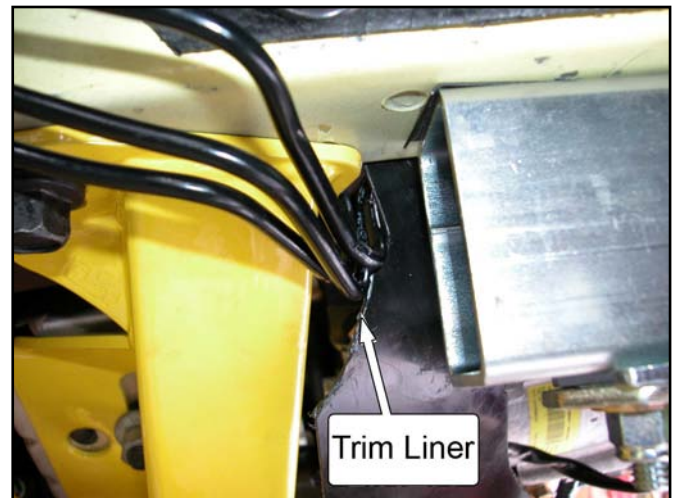
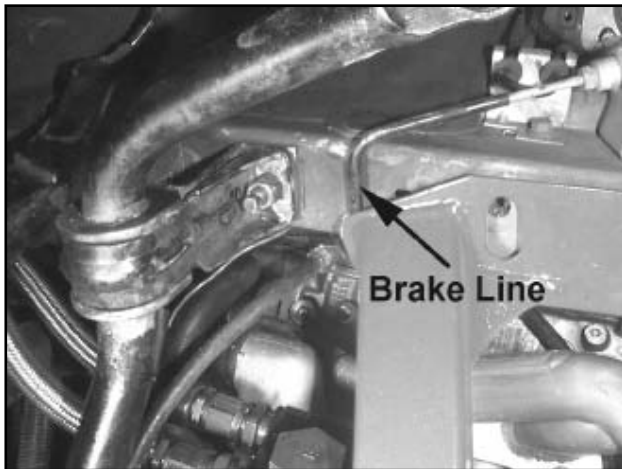

42. Once the K-member is within 1/2" of the frame rails, stop and install all eight K-member mounting bolts that hold the K-member to the chassis. Note that each pair of the rear K-member mounting bolts thread into nuts captured by a single removable nut plate.
43. Tighten the four upper K-member mounting bolts until the K-member is seated firmly against the frame rails. Do not tighten the four rear K-member mounting bolts.

Squaring the K-member

It is necessary to adjust the position of the K-member so it is square in the vehicle. This is accomplished with the aid of a plumb bob (two plumb bobs makes the job much easier), two C-clamps, a tape measure, a pen, masking tape and the two supplied angle iron guides.

NOTE: You must square the MM K-member to the rear suspension pick-up points. To do so, the rear control arm to chassis bolts must be installed in Ford's original orientation. Ford installs the bolts through the chassis from the inboard side of the frame rail with the threaded end toward the outside of the chassis. Check the orientation of these bolts. If necessary, reverse their orientation.

44. Wrap the plumb bob line $\frac{1}{2}$ turn around the front (chassis end) mounting bolt of the rear lower control arm or front IRS subframe mounting bolts. This bolt can be accessed through the hole in the torque box just in front of the rear tire. The line should be over the threads of the bolt, all the way against the nut face. Hang the plumb bobs in the exact same manner on both sides of the car. For example, make sure the line hangs off the bolt from the forward side or rearward side on both sides of the car. Make sure that the line hangs down from the bolt without touching any bodywork. If it does touch the chassis, bend the interfering metal out of the way.

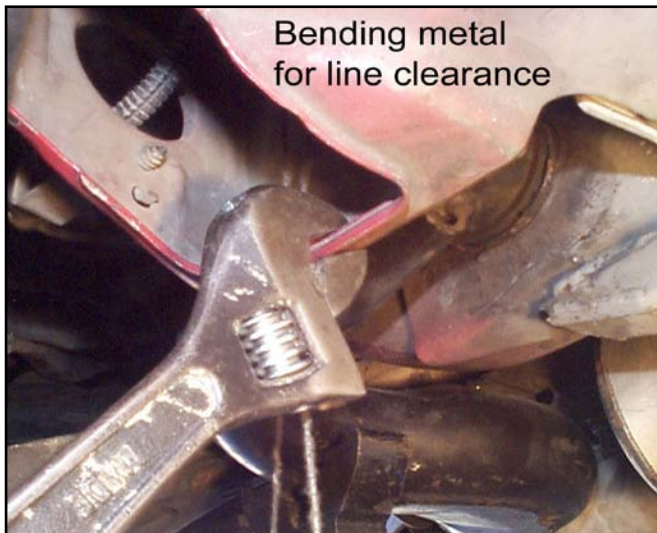
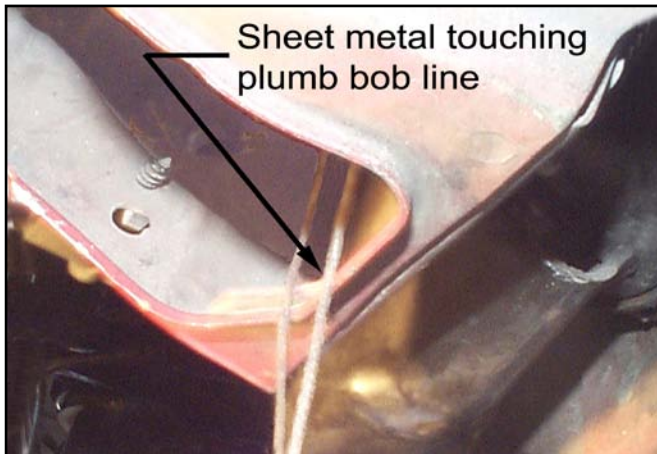

45. Adjust the height of the plumb bob until it is very close to touching the ground. Tie a large weight to the free end of the line as an anchor, or secure the line by taping it to the chassis.
46. Stick pieces of masking tape to the ground directly under the tip of each plumb bob.

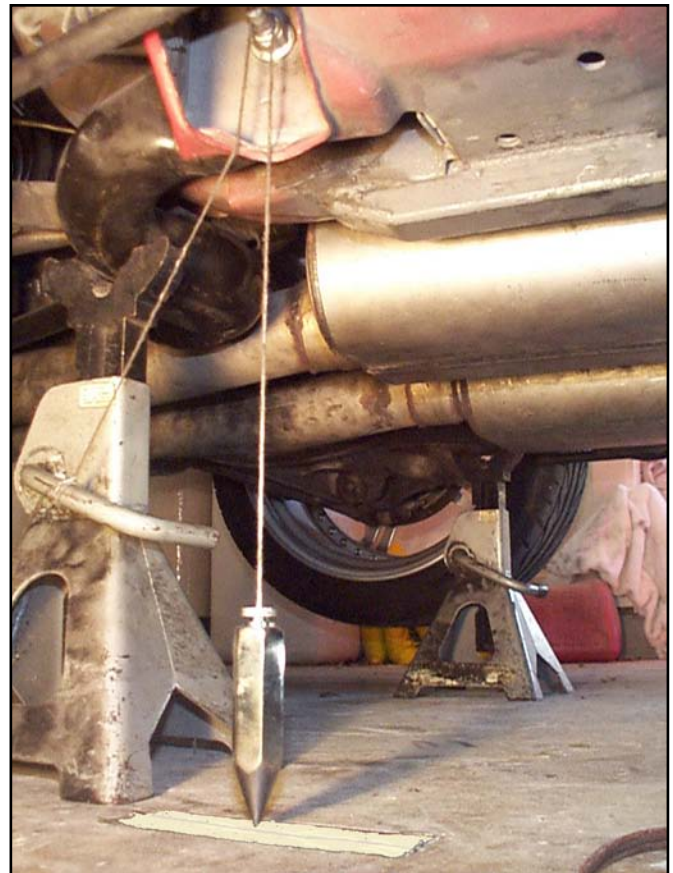

47. Wait for the plumb bob to stop swinging. Mark the position of each plumb bob by placing a small dot on the tape directly under the tip of the plumb bob.

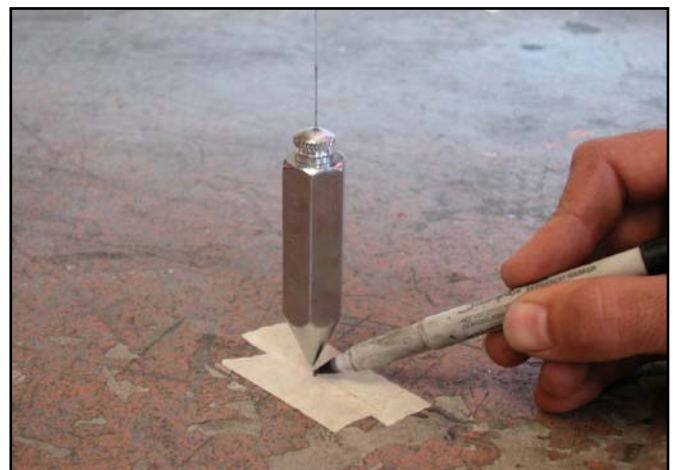

48. Remove the plumb bobs.
49. Go to the front of the car. Pass the plumb bob line through the very small hole located below the most rearward, lower mounting hole for the front control arm. Pass the plumb bob line through from front-to-rear.
50. Adjust the height of the plumb bob until it is very close to touching the ground. Make sure the line is centered at the lowest point of the hole. Place a piece of masking tape on the back side of the control arm tab on the K-member to fix the height of the plumb bob.

51. Stick pieces of masking tape to the ground directly under the tip of each plumb bob.



52. Wait for the plumb bob to stop swinging. Mark the position of each plumb bob by placing a small dot on the tape directly under the tip of the plumb bob.

The measurements taken in the following steps will require two people.

53. Measure the distance between the two dots on the ground on the left side of the car.



54. Take the same measurement between the two dots on the right side of the car.
55. These two distances should be the same. If the distances are not equal, on the side of the car with the shorter distance, loosen the two upper K-member mounting bolts. On the side of the car with the longer distance loosen only the rear upper K-member mounting bolt.

56. Using a rubber mallet or a pry bar, move the K-member on the shorter side forward enough to equalize the distances on both sides of the car. Snug the four upper K-member mounting bolts.

57. Make new dots on the ground to mark the new position of each of the front plumb bobs.
58. Re-measure the distances between the dots on both sides of the car and compare them.
59. Repeat this procedure until the distances match each other within 1/16".
60. If you are unable to move one side of the K-member forward enough, you may have to move the opposite side rearward.
61. If you think you may have disturbed the car on the jack stands, place the plumb bobs back onto the rear control arm mounting bolts and check that the dots on the masking tape are still indicating the correct position of the rear plumb bobs.

62. Once the wheelbase on each side of the car is equal, the next step uses the supplied angle iron guides. Clamp one angle iron guide underneath the frame rail directly in front of, and touching, the K-member. Use a C-clamp or large vise grips. It may be necessary to remove the rearward front swaybar bushing bracket studs from the frame rail. Repeat this on the other side of the car. These angle iron guides form stops to keep the K-member aligned front-to-rear while centering the K-member side-to-side in the following steps.

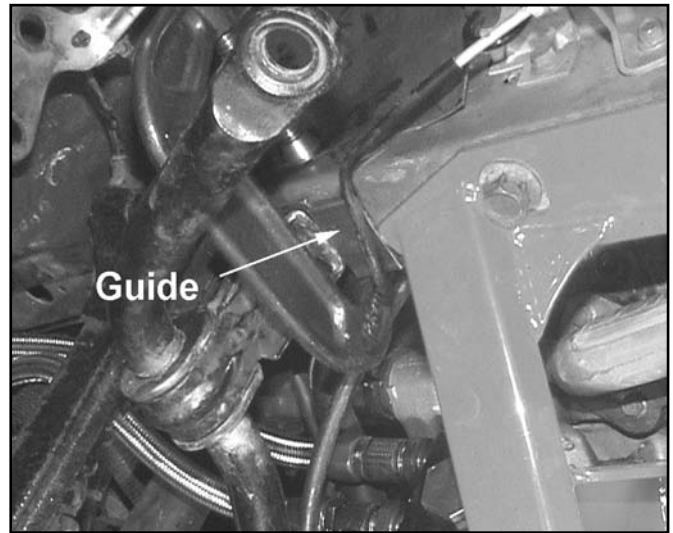

63. Measure the diagonal distances between the four dots on the ground. Record the distance from the dot on the front driver side of the car to the dot on the rear passenger side of the car as D3. Record the distance from the dot on the front passenger side of the car to the dot on the rear driver side of the car as D4.

64. If D4 is greater than D3, the K-member needs to be moved towards the driver side the car. If D4 is less than D3, the K-member needs to be moved towards the passenger side of the car.
65. Scribe a line in the fore/aft direction on the angle iron guide on one side of the car. Extend this line rearwards straight onto the bottom of the K-member flange (the flat plate which bolts to the chassis). This will be used as a reference to determine how far you have moved the K-member.
66. Loosen the four upper K-member mounting bolts. Tap the K-member from the side until it has moved the appropriate distance. This can be done with a large dead-blow hammer or a steel hammer and block of wood.
67. Tighten the 4 upper K-member mounting bolts, mark new dots with the plumb bobs and re-measure distances D3 and D4.
68. Repeat these steps until the difference between D4 and D3 is 1/8" or less. This means the K-member is centered left to right under the car.
69. Once the K-member is properly positioned, place the plumb bobs back onto the rear control arm mounting bolts and check that the dots on the masking tape are still indicating the correct position of the plumb bobs. If not, this indicates that the car has shifted on the jack stands. If it has shifted, you will have to go through the squaring procedure again.
70. Torque the four upper K-member mounting bolts to 89 ft-lbs.
71. Torque the four rear K-member mounting bolts to 72 ft-lbs.
72. Remove the C-clamps and angle iron guides.
73. Gently lower the engine down onto the K-member, making sure not to pinch any lines or wires. Watch header clearance to avoid denting a header tube. Install the engine mount nuts onto the engine mount studs and torque to 95 ft-lbs.
74. Remove the engine hoist or engine support beam.
75. If possible, move the MM K-member brace up by removing one or more of the spacers from between the K-member brace and K-member, which were installed at step 39. Do this until the K-member brace is as high as possible, but still has 1/4 inch of clearance to the oil pan. If necessary, use the shorter bolts provided. Tighten the two Grade 8 bolts to 100 ft-lbs.
76. Drill a 1/8" hole in the driver side frame rail just forward of the k-member and reattach the ground strap.

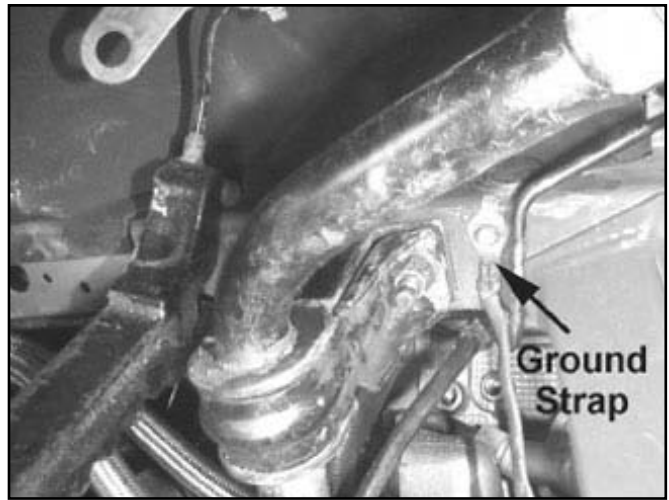

Control Arm Location

The MM K-member has two sets of mounting holes for the front control arms. The lower set is raised 1 inch from the stock location. These holes should be used for all street driven vehicles. The upper set of holes is raised 2 inches from the stock location and is intended for race vehicles that have increased the amount of rear bump travel from stock.

Control Arm Assembly

See the instructions which came with your MM Front Control Arms.

Control Arm Installation

All MM K-members built after 3/11/2008 include a set of our MMF-2 Low Profile Front Control Arm Bolts that are intended to be used on the forward pivots of the front control arms. Please follow the directions carefully to ensure proper installation.

77. Grease all exposed faces of the front control arm bushings using Prothane's Super Grease supplied with your MM Front Control Arms.
78. Slide the control arm into place on the K-member with the sway bar mount facing toward the front of the car.
79. Install one of the provided MM Low Profile Front Control Arm Bolts into the forward pivot of each control arm. Install the stock pivot bolts into the rearward pivots using a supplied 5/8" washer under the head. The washer prevents the rearward bolts from bottoming out before the nut is fully tightened.

NOTE: The MM K-member requires all pivot bolts to be installed with the bolt heads toward the front of the car.

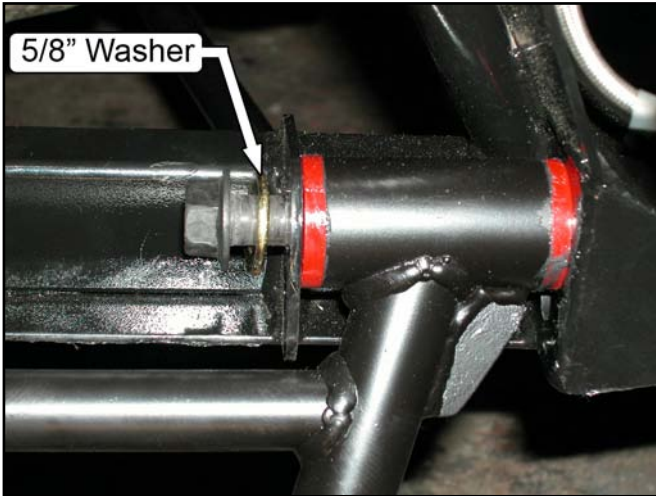

80. Thread a factory nut onto each pivot bolt.



81. Hold the head of the MM Low Profile Front Control Arm Bolt stationary using a T-55 Torx socket and tighten the nut. Torque the nut to 148 ft-lbs.

NOTE: The MM Low Profile Front Control Arm Bolts require holding the head of the bolt in place with a T-55 Torx socket while tightening the nut. Do NOT turn the Torx head to tighten. Instead, hold the bolt still with the T-55 socket and turn the nut to tighten.

NOTE: If you are NOT using MM Front Control Arms, consult the manufacturer of your control arms for their recommended control arm pivot bolt torque. The crush tubes of other brands' front control arms may not be capable of withstanding the factory

specification of 148 ft-lbs of torque. We do not endorse torquing the pivot bolts less than 148 ft-lbs.

82. Torque the remaining MM Low Profile Front Control Arm Bolt using the same procedure described above.
83. Torque the rearward, stock control arm pivot bolts to 148 ft-lbs.

Steering Rack Installation

The MM K-member is specifically designed to use the MMST-6 Aluminum Spherical Rack Bushings. Use of other rack bushings may not yield optimum Ackerman steering geometry and may cause the steering to bind.

Also, versions of the MM K-members prior to 3/11/2008 did not include the **MMF-2** Low Profile Front Control Arm Bolts. If you do not have these bolts, we highly recommend contacting Maximum Motorsports and ordering a set.

84. The MMST-6 Aluminum Spherical Rack Bushings must be in place on the steering rack prior to the next step. See the newest instructions (3/11/2008 or newer) that came with the MMST-6 bushings to install them into the rack. The MMST-6 bushings allow for three different vertical rack positions. In all cases, we recommend positioning the rack as high as possible. This will minimize the height of the spacer stack under the spindle's steering arm.

85. Untie the steering rack from the swaybar. Raise the steering rack into position while engaging the steering shaft onto the steering rack input shaft. The stock steering shaft will only engage onto the rack's input shaft in one orientation. The steering shaft itself includes a collapsible portion, which will extend slightly when pulled.

Unless previously trimmed, the stock steering rack bolts WILL interfere with the k-member handlebar brace. To eliminate this interference, the bolt must be shortened.

86. Screw one nut onto each rack bolt as far as they will go with a wrench. Using a ruler, mark both bolts 6.25" from the underside of the bolt head.

NOTE: The nut will have a lot of resistance, be sure to thread the nut on far enough to provide clearance for your cutting tool.





87. Use a hack saw or grinder to cut each bolt at the mark placed in Step 86.



88. You will need to chamfer the edges of the cut bolts and clean the threads with a file so the OEM Ford nuts will easily start to thread onto the bolts. The bolt thread is M12 x 1.75. If you have a thread file or a die set, this can be used to clean up the threads after a chamfer has been put on the end with a file. After the bolt tips are dressed, remove the nuts as the final step to ensure the threads are properly formed.

NOTE: The top of the nut is slightly deformed to act as a locking feature. Thus, the nut will not fully thread onto the bolt by hand as some resistance is normal.



89. Reinstall the trimmed steering rack bolts, from the front of the k-member.

NOTE: Be sure that the steering rack bolt is passing through the same offset hole in each rack bushing as determined using the latest MMST-6 installation instructions.

90. Install the factory nuts onto the steering rack bolts.



91. Snug the factory nuts onto the steering rack bolts. With offset steering rack bushings, ensure that the bushings as well as the spacers behind the rack are oriented correctly. The three holes in each bushing should be in a vertical line with the center of the bushing.



92. Torque the steering rack mounting bolts to 55 ft-lbs.

93. Reinstall the steering shaft pinch bolt.

94. If you are using the stock steering shaft, torque the steering shaft pinch bolt to 25 ft-lbs. If you are using an aftermarket steering shaft, torque the steering shaft pinch bolt or set screws according to the steering shaft manufacturer's instructions.

95. If using MM Forward-offset Control Arms, now is the time to move the swaybar forward 1" with the MM Relocation Kit (MMFSB-51).

96. An adjustable tie-rod end kit must be installed prior to the next step. A bolt-through spindle style kit such as MM part number MMTR-3 is required. The tapered stud type of tie-rod end will not have enough range of adjustment to correctly adjust bumpsteer with the geometry of the MM K-member.

97. Place the floor jack under one of the front control arms, and raise it to a comfortable working height. Install the spindle onto the balljoint. Thread the nut on the ball joint stud a few turns.



98. We now recommend installing MM caster/camber plates, if the car is not yet so equipped.



99. Install a front coil-over conversion kit now, if the car is not yet so equipped.



100. Install the coil-over strut assembly into place in the caster/camber plate. Adjust the spacers between the upper spring perch and the caster/camber plate as per the MM Front Coil-over Kit instructions to allow for maximum bump travel.

101. Raise the floor jack to align the spindle with the strut. Install the strut bolts from the rearward side of the spindle.



102. Attach the adjustable outer tie-rod end to the spindle. As a starting point, place a 2" stack-up of spacers between the spindle and the tie-rod end. Torque the tie-rod end bolt to the specification stated in your adjustable tie-rod end kit.

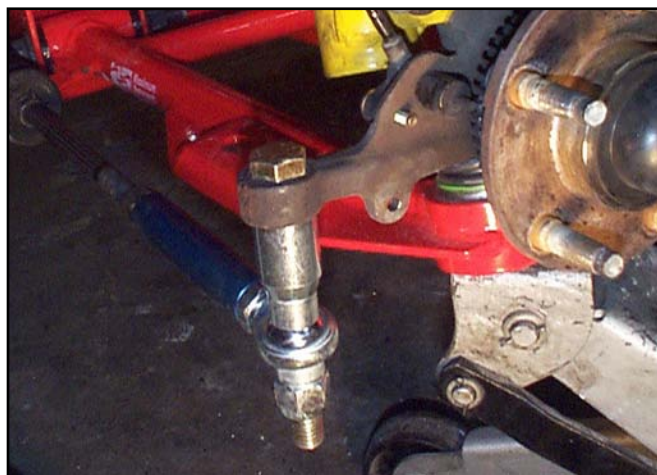

103. Torque the ball joint nuts to 129 ft-lbs.
104. Torque the strut-to-spindle bolts to 148 ft-lbs. Torque the strut top nut to the specification given by your strut manufacturer.
105. Install the brake rotor, the caliper bracket (if applicable) and the brake caliper. Torque the caliper bolts and/or caliper bracket bolts to the appropriate manufacturer/factory specs. Re-attach the ABS sensor.
106. Repeat Steps 94-102 on the other side of the car.

Clearance

107. On each side of the car, place the floor jack under the front control arm. Adjust the lower spring perch to its lowest possible position. Cycle the suspension through full bump and droop with the jack while turning the front wheels from lock to lock. Check for interference between any suspension components.
108. Reinstall the front wheels. Tighten the lug nuts.
109. Depending upon the following parameters, there may be varying degrees of interference between the tire and the fender.
- Wheel size.
 - Wheel offset .
 - Tire size—be aware that the same nominal size tire from different manufacturers can have different actual sizes.
110. Again, on each side of the car, place the floor jack under the front control arm. Raise the control arm until the spindle is at your previous ride height. Use the dimension D1 you recorded in Step 3 to set the relationship between the spindle and the fender. Check for interference between the tire and the fender. Cycle the suspension through full bump and droop with the jack while turning the front wheels from lock to lock. Again check for interference between the tire and the fender. The inner fender lip may need to be rolled under for clearance. Also check for clearance between the tire and the front fender extensions. Be aware that the tire clearance may change after the front alignment is done.
111. In general, 1996 and newer cars do not require any modifications when using the zero-offset control arms. Using the forward-offset control arms may require minor trimming of the plastic front bumper cover and front spoiler. Most of this trimming is inside of the wheel well area, and is therefore very unobtrusive.
112. Thread the lower spring perch upwards until the spring is touching both the lower and the upper spring perches. Adjusting the spring perch so the spring is just starting to compress is a good starting point for adjusting ride height. Final ride height will be set after

the car is back on the ground.

113. Remove the jack stands and set the car on the ground. Torque all your lug nuts to factory specifications. Roll the car back and forth to settle the suspension. Adjust the front ride height back to its original setting using the dimension D2 you recorded in Step 3. With coil-overs you may further change the ride height to your liking.
114. Do an approximate alignment of camber, caster and toe by eye. If camber or caster is changed significantly you may need to check tire clearance again by repeating the previous steps.
115. Tighten the tie-rod end jam nuts. Check both the nut between the rod-end and the tie-rod end sleeve, as well as the nut between the tie rod and tie-rod end sleeve.
116. Reinstall the swaybar end links. It is likely that with the revised control arm geometry, you will need shorter end links. Rotate the swaybar until the forged end link hole is horizontal. Measure the distance between the swaybar end link hole and the swaybar end link hole in the front control arm. This is the ideal end link length. Use end links that are as close as possible to this dimension (MM P/N 19-408 to 19-417). Be careful not to over tighten and crush the endlink bushings.
117. Reconnect the battery ground cable.

Final Alignment

The car's behavior before correcting the alignment and bumpsteer will be very unstable. Driving the car before the alignment and bumpsteer is corrected is not recommended.

Remember that the ride height must be set before doing the final alignment. Any time that the ride height is changed the camber and toe settings must be readjusted.

Alignment recommendations when using the MM K-member: For street driven cars, set caster at 6 degrees positive; camber at $\frac{3}{4}$ degree negative; toe-in set to a total of $\frac{1}{16}$ ". Race car alignments are very dependent on tires, track, and driving style and should be adjusted according to tire wear, tire temperatures, and preferred balance of the car. Generally speaking, a more aggressive alignment than the street setting is desirable.

Bumpsteer

The camber, caster and toe must be set before correcting bumpsteer. Adjust the car's bumpsteer according to the copyrighted instructions you received with your MM Adjustable Tie-Rod End Kit.

Test drive and enjoy! Re-torque all bolts and nuts after 1000 miles.

This kit contains the following items:

- 1 K-member
- 1 K-member brace
- 2 Flat washers, 5/8" grade 8
- 2 Flat washers, M12 x 24mm OD
- 6 Flat washers, 1/2" grade 8
- 2 Hex bolt 1/2" - 20 X 1-1/4" grade 8
- 2 Hex bolt 1/2" - 20 X 2" grade 8
- 2 Low Profile Front Control Arm Bolt
- 2 Angle iron guides
- 4 K-member Brace Spacer

Ford Modular Engine Support Beam

Plan View

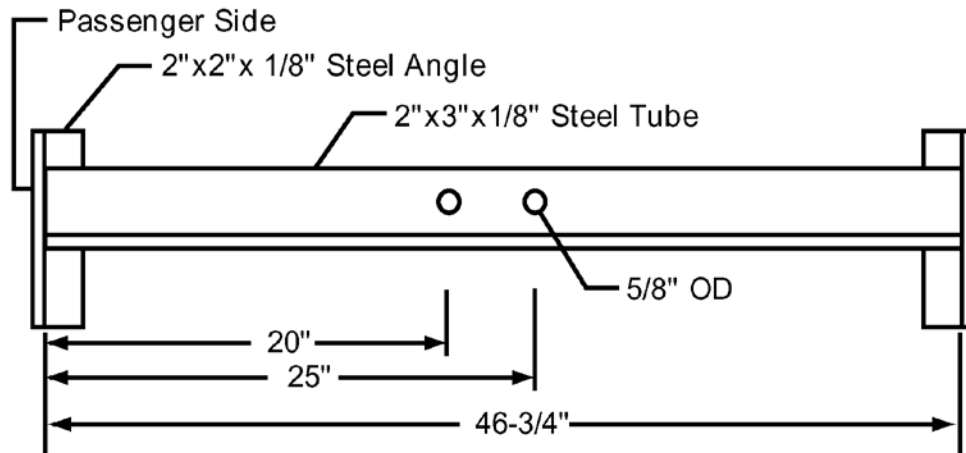

Passenger Side View

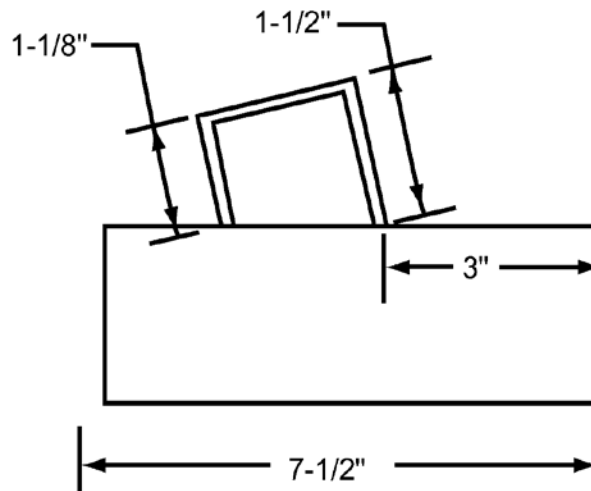

Fabrication Notes:

1. Break bottom corners of 2x3 steel tube to allow a flush fit in corner on steel angle
2. Use 5/8" hole saw for forming holes
3. Weld at all seams between steel angle and steel tube
4. Break corners and edges of steel angle that engage the sheetmetal of vehicle
5. Use 12"x1/2" eyelet bolts with 1/2" rod couplers and 1/2" washers