

RetroBelt[®] USA

Custom 3-Point Seatbelt Installation Guide for: 1965 - 1973 Mustang

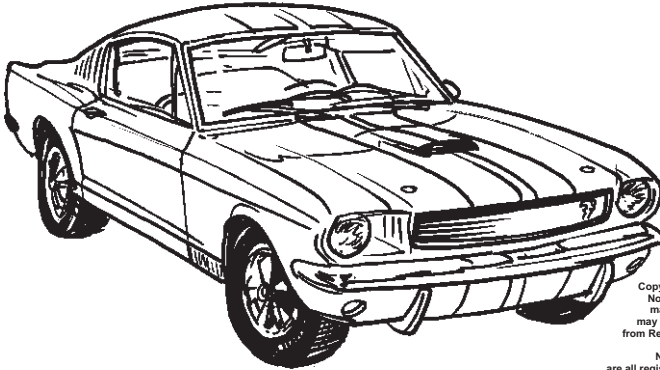
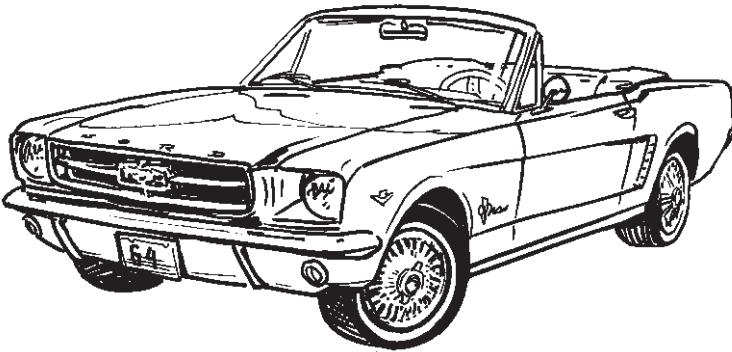

Copyright ©2009 Retro Belt USA, LLC
No text, illustrations or format of this
manual in printed or electronic form
may be copied without written permission
from Retro Belt USA, LLC. All Rights Reserved.

Note: Ford, Mustang, Mustang GT
are all registered trademarks of The Ford Corporation

Note: The information enclosed in this installation guide is to be used as merely an outline to assist you during the process of installation. This guide does not cover every installation possibility, vehicle, or every aspect of the installation process.

RetroBelt USA, LLC, or its subsidiaries, assume no responsibility for a proper or improper installation. Every attempt has been made to make this installation guide as informative as possible, and therefore may be updated from time to time. Please check our website for the latest update. (www.retrobeltusa.com).

Version 1.1

'65 - '73 Mustang Seatbelt Hardware Install Kit

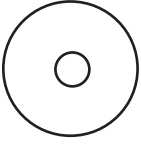

2.48" Diameter
Oversized Fastener/anchor
Qty included: (8) Pcs



7/16" nut
Qty included: (10) Pcs



.748" Diameter
Washer
Qty included: (10) Pcs



1.77" (7/16)
Grade 5 Hex Anchor Bolt
Qty included: (10) Pcs



7/16"
Nylon Spacers
Qty included: (8) Pcs

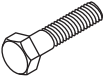

1.73" (7/16)
Grade 5 Hex
Shoulder Anchor Bolt
Qty included: (2) Pcs



1.26" (7/16)
Grade 5 Hex Anchor Bolt
Qty included: (4) Pcs

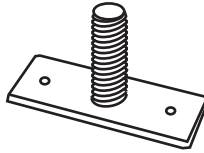

Grade 5 7/16 "T" anchor mount
with solid threaded bolt
Qty included: (2) Pcs

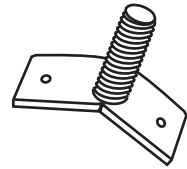

Grade 5 anchor mount
with 1 threaded anchor holes
Qty included: (2) Pcs

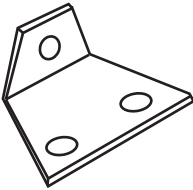

Grade 5 "L" anchor adapter
with 3 anchor holes
Qty included: (2) Pcs



Grade 5 anchor mount
with 1 threaded anchor holes
Qty included: (2) Pcs

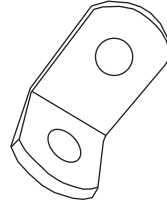

Grade 5 "L" anchor adapter
with 2 anchor holes
Qty included: (2) Pcs

Note, the installation hardware above has been put together to cover as many variations of the Mustang as possible. In many instances if your vehicle has existing anchor points installed you may not need some of this hardware, please look over the installation guide for your type of vehicle, feel free to contact us for any questions you have.

Note: The information throughout this guide regarding retrofitting is to be used ONLY as a guideline for installing anchor points in vehicles that are not equipped with anchor points. The retrofitting steps in this manual should be performed by professional installers to ensure that the installation is as safe as possible.



Thank you for your purchase of this Retrobelt USA seatbelt product. Your Seatbelt product has been rigorously tested by an independent laboratory to meet or exceed Federal Motor Vehicle Safety Standards (FMVSS) #208, #209 & #302.

Please feel free to contact us via phone or email regarding any further technical questions or support.

LEGAL DISCLOSURE:

RetroBelt USA, LLC, or its subsidiaries, assume no responsibility for a proper or improper installation. Every attempt has been made to make this installation guide as informative as possible, and therefore may be updated from time to time. The retrofitting steps in this manual should be performed by professional installers to ensure that the installation is as safe as possible. Please check our website for the latest update. (www.retrobeltusa.com).

GOVERNMENT REGULATION INFORMATION:

All US passenger cars, beginning with 1962 models, have seat belt anchorages for at least two lap belts in the front seat area. Since January 1, 1968, vehicle manufacturers have been required to install lap belt anchorages for each front and rear seating position and upper torso belt anchorages at each forward facing outboard seating position. On January 1, 1972, this same requirement became effective for trucks.

IMPORTANT!

Where the vehicle manufacturer has made special provisions to attach belts, be sure to use these fittings.

When you use the manufacturer's threaded floor fittings, it is important that all full threads be engaged to obtain the ultimate strength of the anchorage point.

NOTE:

Seatbelts should NOT be attached to the seat, unless the vehicle manufacturer indicates that the seats and seat mounting systems have been specifically designed to withstand seat belt assembly loads.

PREPARING FOR SEATBELT INSTALLATION:

This custom installation kit will allow you to install most belts for the specified series of vehicle, however there may be some modifications that may need to be made to the vehicle's frame or interior to accommodate a safe anchor point for the belt system.

Determine if your installation is a retrofit (no original seatbelts installed) or if you will be replacing existing 2 point belts and can use some of the existing anchor points. (Note: it is important that wherever you can, to use the factory anchor points, if it is determined that you must make your own anchor points, be sure to check behind or below where you will be drilling for adequate clearance for the bolt and reinforcement plate. Please note, that when drilling you don't accidentally drill into fuel lines, exhaust system, gas tank, brake lines, etc. If you have any question that the area you want to anchor to is weak, rusty, or otherwise not suitable, do not use it!

The included hardware kit does include SAE Grade 5 metal anchors and bolts for reinforcement purposes, it is always wise to reinforce an anchor point to ensure the safety of you and your passengers.

Custom Installation guidelines:

Note: This information is to be used as a guideline for installing anchor points in vehicles that are not equipped with anchor points. The retrofitting steps in this manual should be performed by professional installers to ensure that the installation is as safe as possible. Please check our website for the latest updates. (www.retrobeltusa.com).

Where to Install Anchor Points:

Determine if your installation is a retrofit (no original seatbelts installed) or if you will be replacing existing 2 point belts and can use some of the existing anchor points. (**Note:** it is important that wherever you can, to use the factory anchor points, if it is determined that you must make your own anchor points, be sure to check behind or below where you will be drilling for adequate clearance for the bolt and reinforcement plate).

IMPORTANT: When drilling be careful to not accidentally drill into fuel lines, exhaust system, gas tank, brake lines, etc. If you have any question that the area you want to anchor to is weak, rusty, or otherwise not suitable, do not use it! The optional hardware kit does include some SAE Grade 5 metal anchors for reinforcement purposes, it would be wise to reinforce an anchor point to insure the safety of you and your passengers.

Front (Driver & Passenger) Installation guide for '64 1/2 - '67 Mustang Coupe & Convertible / '68 - '73 Mustang Convertible*:

1. Set up the Retrobelt system without installing hardware to check placement, remove seats (if necessary), check underneath floor & behind the side panel for ample room for drilling

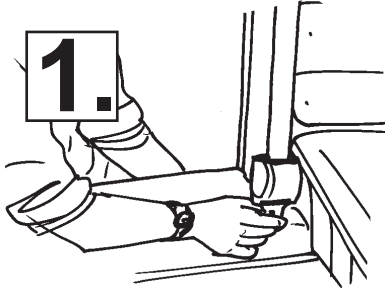

*Note: Some 1964 1/2 and early '65 Mustangs may require drilling of anchor points and the installation of anchor plates underneath the floor & behind side panels to ensure a safe and secure installation.

Installation overview for Front (Driver & Passenger) Installation guide for '64 1/2 - '67 Mustang Coupe & Convertible / '68 - '73 Mustang Convertible:

OVERVIEW

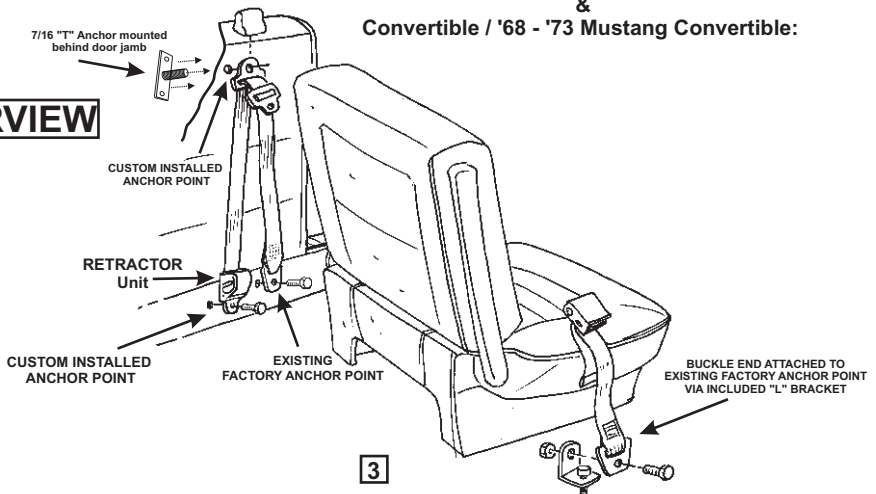

**(CONTINUED) Front Seat (applies to passenger & driver)
Installation Guide for:
'64 1/2 - '67 Mustang (Coupe & Convertible)
'68 - '73 Mustang (Convertible)**

2.

Once the anchor point sites have been chosen and you need to determine that they are solid locations and that you have access behind them.

Line up the retractor and shoulder guides in the desired position for placement. It is critical to make sure that the installation does not interfere with the belt webbing, so the retractor has unobstructed operation for maximum safety.

Make templates out of cardboard for where the retractor & shoulder guide will be mounted and you may need to use one of the included hardware kit's anchor plates as a template for drilling the anchor point.

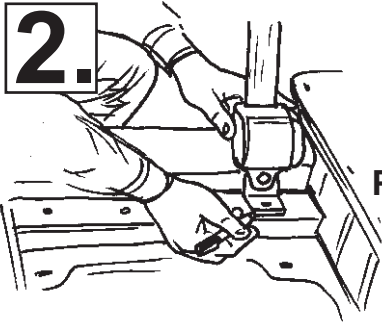

**Trace
for
Placement**

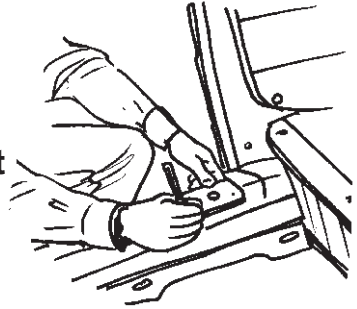

3.

To install the Shoulder guide anchor point under the rear window, first use a center punch to indent the sheet metal in the door jamb, then progress to a small drill bit to start drilling, then use the desired drill bit size to accommodate the 7/16" Hex bolt and place the metal "T" anchor in the door jamb with threads facing the inside of the vehicle (see illustration below).

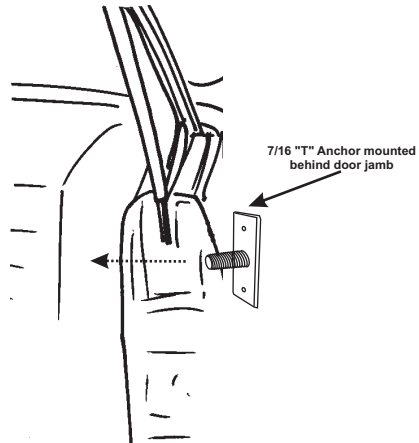
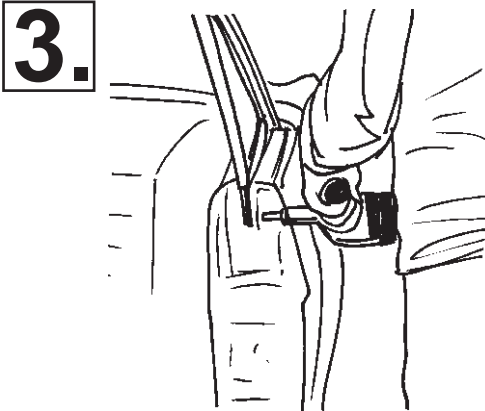

4

**(CONTINUED) Front Seat (applies to passenger & driver)
Installation Guide for:
'64 1/2 - '67 Mustang (Coupe & Convertible)
'68 - '73 Mustang (Convertible)**

4.

Once Retractor & shoulder guides are in place, install the third mount to the floor using either the existing manufacturer's anchor mount or install a new anchor point using the methods previously described (see illustration below). It is important to make sure that the webbing of the seat belt be tangle free and unobstructed from operation to ensure maximum safety. Once all anchor points have been installed, and belt has been tested, tighten the bolts down and try your new Retro Belt.

**Installation overview for Front (Driver & Passenger)
Installation guide for '64 1/2 - '67 Mustang Coupe
&
Convertible / '68 - '73 Mustang Convertible:**

4.

7/16 "T" Anchor mounted
behind door jamb



Outside view of Door Jamb area

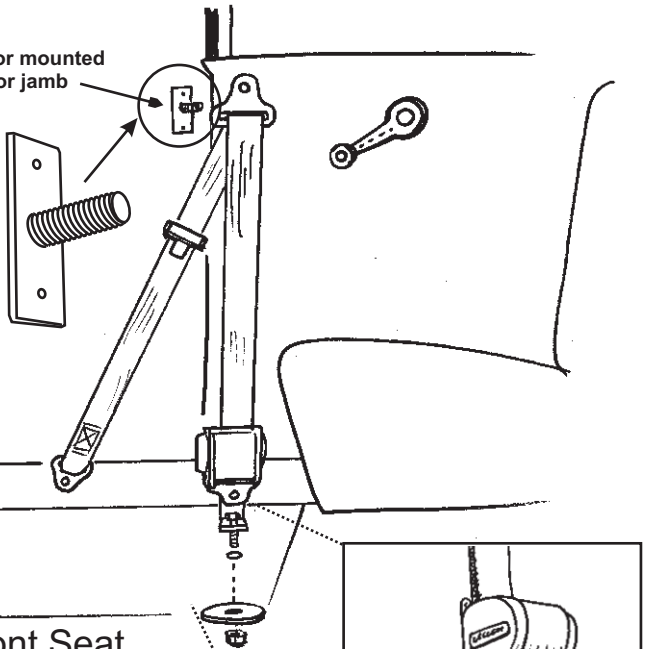

Front Seat
Area of Mustang

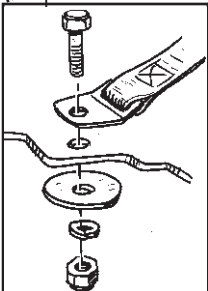

Detail showing Belt End mounted to floor using Round anchor plate installed underneath floor (beneath car)

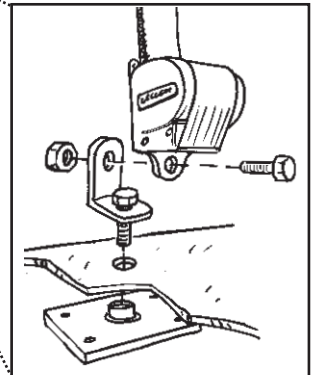

Detail showing anchor plate installed underneath floor (beneath car).

5

**(CONTINUED) Back Seat (applies to passenger & driver)
Installation Guide for:
'64 1/2 - '67 Mustang (Coupe & Convertible)
'68 - '73 Mustang (Convertible)**

Note: use rear Retro Belt for Back Seat Installation, as there is no shoulder anchor used or needed for this type of installation.



Note: The illustrations below show the variations available for the installation of the Rear Retro Belt system in a back seat. Please note that whenever possible, to mount the anchor on a solid portion of the floor behind the back seat, being careful to note where the anchor points are drilled. Check underneath the vehicle for clearance and ensure that you won't drill into fuel lines, gas tank, etc. Use similar methods of drilling new anchor points as were used for the front belt installs. Be sure to always use the included round or rectangular steel anchor plates to ensure a safe installation. Once installation is complete, install the buckle end to an anchor point, then run the buckle end through the bottom of the seat so passengers have access to the buckle

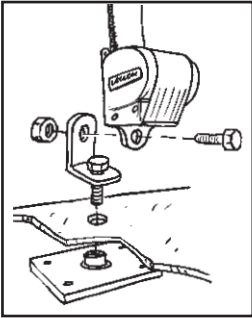

Note:
For this installation, mount the retractor unit behind the back seat on the floor. Use the included anchor plate to ensure that the installation is as solid and safe as possible.

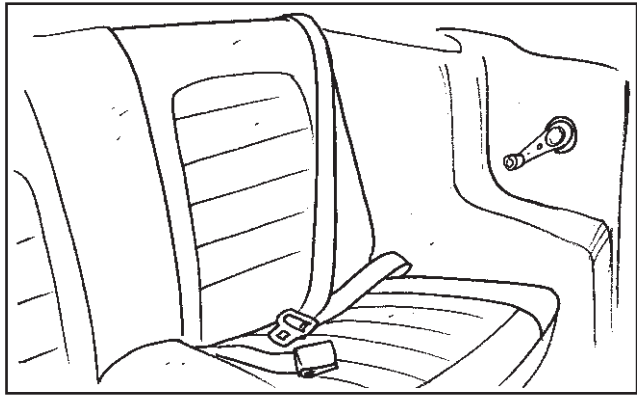

ALTERNATE INSTALLATION OPTION

Note:
This alternate installation option should only be attempted if the rear deck of your Mustang is solidly attached to the frame of the vehicle. If you are going for a "stealth" mounting approach, use the installation option above. Use the previously mentioned methods for creating new anchor points to ensure a safe and secure installation.

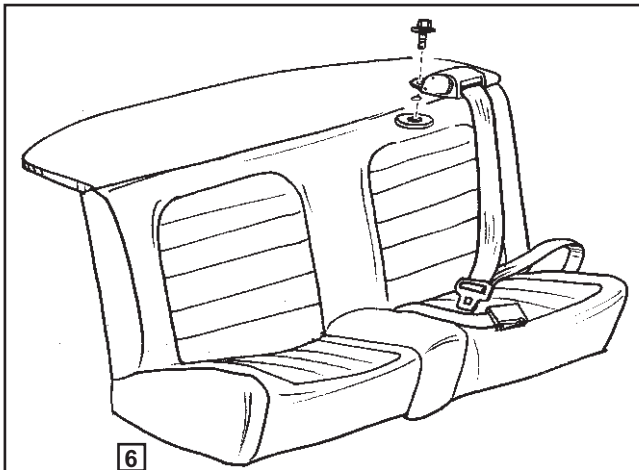

Front Seat (applies to passengar & driver) Installation Guide for: '68 - '73 Mustang (GT Fastback/Coupe)

This installation in most cases involves using existng factory locations for all anchor points, however in some earlier versions of this vehicle you may have to create the shoulder anchor point yourself. The retractor & belt ends can use the existing factory anchor points and if the vehicle already has the hard top roof anchor point, simply clean the excess dirt & debris and use the shoulder point bolt, then attach the 3 way belt system using the existing anchor points.

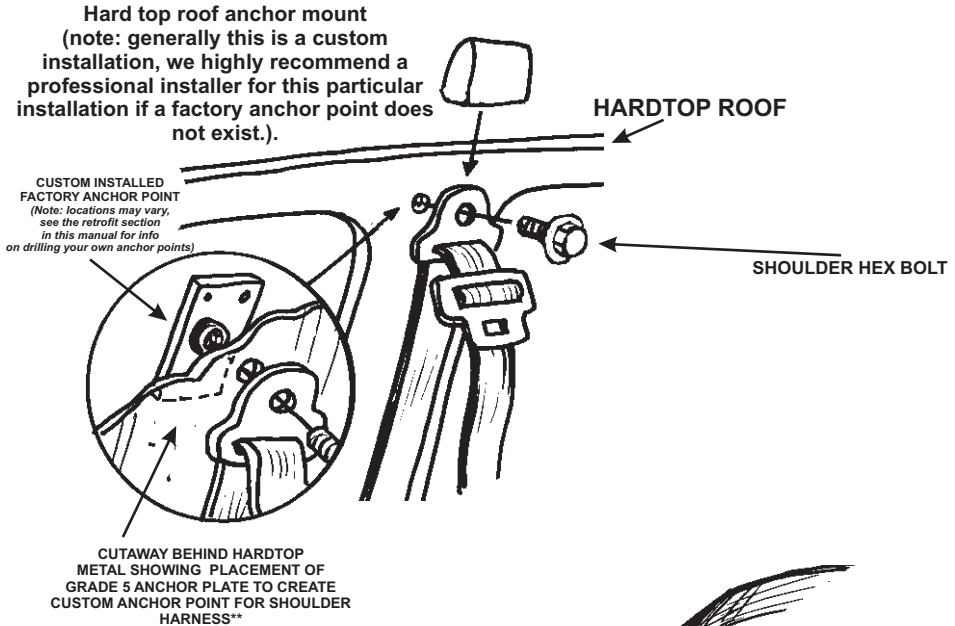

Belt end

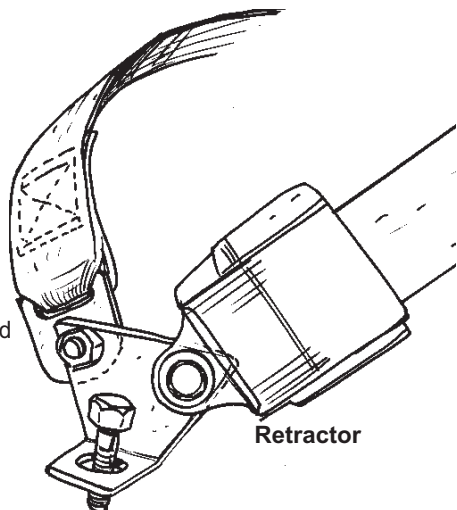

**Included 3-way
anchor point adapter**

Generally this series of Mustang is quite compact and to save space in the installation, you may have to use the included 3-way anchor point adapter (see illustration on the right) to allow the use of one common anchor point for both the retractor and the belt end.



Use & Care of your new seat belt:

1. Always wear your seatbelt, visit www.buckleupamerica.org to learn more about using your seatbelt safely.
2. Adjust and wear the lap belt portion low and tight across your hips.
3. Each belt is intended to restrain only one person at a time.
4. Never attempt to restrain a child in your lap using the 3-point retractable seat belt around both you and the child. The child could be severely injured or even killed in the event of a collision. Please check with your state for local laws regarding the use of safety belts and small children.
5. Do not mix or use this belt or parts of this safety system with other types of seat belts, doing so may result in the belt becoming non operational.

WARNING: FAILURE TO PROPERLY INSTALL, USE, PERIODICALLY INSPECT AND MAINTAIN THIS SEAT BELT COULD LEAD TO SERIOUS INJURY OR DEATH! PLEASE FOLLOW ALL OF THE IMPORTANT INFORMATION BELOW:

Maintenance:

1. Inspect belt and retractor assembly regularly. If the assembly does not work properly or you find cuts, frayed or worn webbing the belt must be replaced.
2. More frequent inspections may be necessary if the belt is subjected to harsh treatment or extreme conditions.
3. Whenever a vehicle is involved in a collision you must replace every part of the seat belt system; both sides of the belt including the mounting hardware!
4. Clean with mild soap and water. Do not bleach or re-dye as it will tend to severely weaken the webbing.
5. Please note that extensive exposure over the years can weaken the webbing on older seatbelts. This effect can reduce the webbing's effective safety feature by over 50%, so it is important to always check your seatbelts periodically for any wear & tear.

CAUTION: DEATH OR SERIOUS INJURY COULD RESULT FROM NOT PROPERLY THREADING THE WEBBING THROUGH THE ADJUSTABLE ENDS. MAINTAIN A MINIMUM OF ONE INCH WEBBING BEYOND THE ANCHOR.

CAUTION: IF THE FIXED END OF A SEATBELT IS TOO LONG TO ALLOW A SNUG FIT ON A SMALL OCCUPANT, DO NOT USE THE BELT! AS A GENERAL RULE, CHILDREN WEIGHING LESS THAN 80 LBS SHOULD BE SECURED IN AN APPROVED CHILD SAFETY/BOOSTER SEAT ACCORDING TO MANUFACTURER'S RECOMMENDATIONS!!!



Warranty:

RetroBelt USA, LLC warrants our products for one year (365 days) from the date of original purchase to be free from defects in materials and workmanship. If, during this period, the product fails under normal usage, because of a manufacturing defect, we will replace or repair the item.

Please note that the retractor and buckle assembly are the only items on the seatbelt that are covered by this limited warranty. The belt webbing and associated hardware are not covered under our warranty.

To obtain repair or replacement under the terms of this warranty, please contact us via phone or email (service@retrobeltusa.com) and request a return authorization number. Proof of purchase and date of purchase are required to validate the warranty claim.

If the seatbelt has been involved in an accident, RetroBelt USA, LLC and its subsidiaries cannot be held liable and the seat belt system cannot be warrantied, repaired, or returned.

RetroBelt USA, LLC, or its subsidiaries, assume no responsibility for a proper or improper installation. Every attempt has been made to make this installation guide as informative as possible, and therefore may be updated from time to time. The retrofitting steps in this manual should be performed by professional installers to ensure that the installation is as safe as possible. Please check our website for the latest updates. (www.retrobeltusa.com).

We are not liable for any direct or consequential loss or property damage arising from any use of this product. This warranty gives you specific legal rights, and you may also have other rights, which vary from state to state. Offer good in U.S.A. and Canada only.

RetroBelt[®] USA

Custom 3-Point Seatbelt Installation Guide for: 1965 - 1973 Mustang

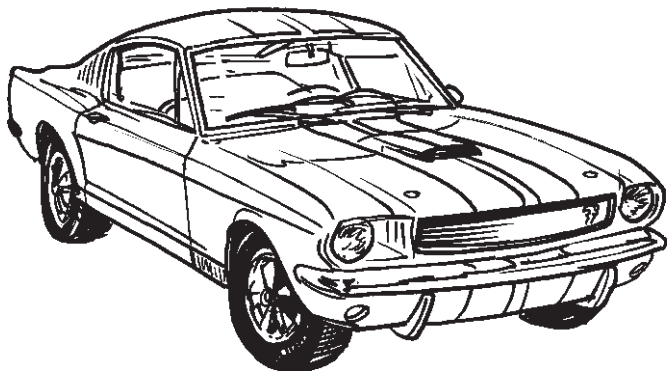
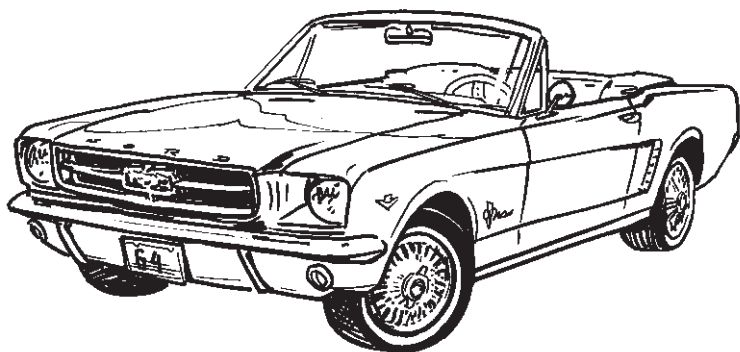

Need a radio or speaker for your Mustang? Check out our Model One Radio and speakers at www.retrosoundusa.com !

RetroBelt USA, LLC
13831 Roswell Ave, Unit # J
Chino, California 91710
Phone: 909-364-1372
Fax: 909-364-8670

www.retrobeltusa.com