

## Seat Types

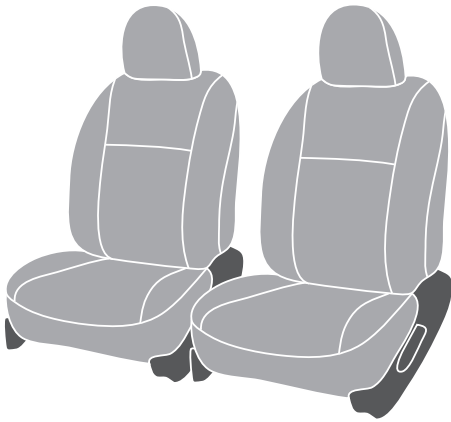

Buckets



Captains Chairs

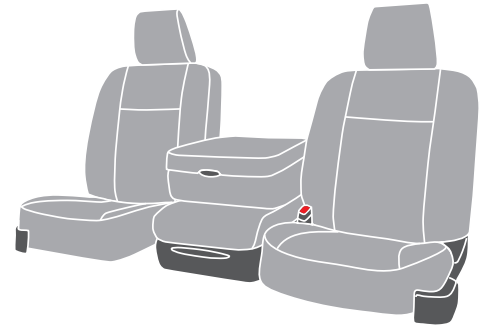

40/20/40

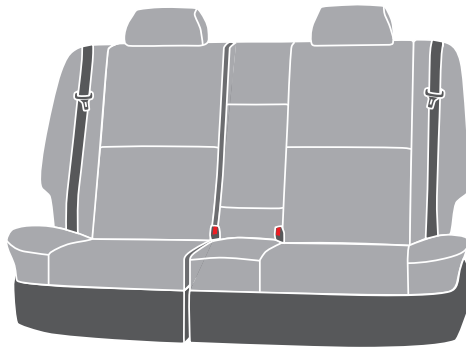

Split Bench

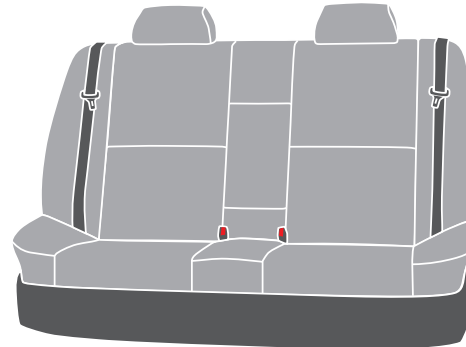

Solid Bench

### Tips & Tricks

- Always wear eye protection when installing covers.
- Elastic straps can snap back at you if released suddenly.
- The included plastic strip is useful for pushing cover and straps through small spaces.

## Headrest Cover Installation

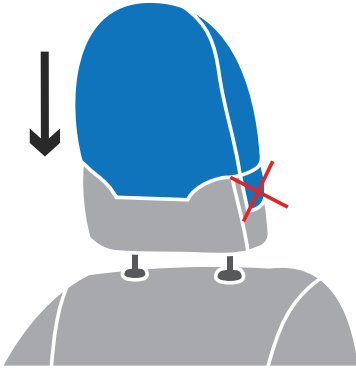

### Installation

- With the headrest installed in the seat pull down on the front and back of the headrest cover.
- DO NOT pull on the side flaps.
- Smooth cover in place and tuck in cover around any buttons.

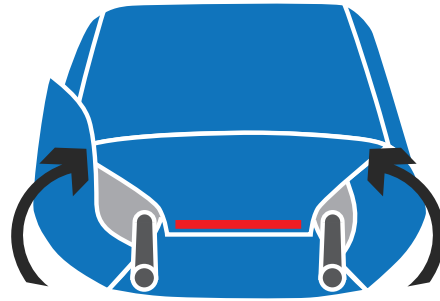

### Tips

- Try turning the cover half inside out, positioning the top and rolling the cover down.
- Ensure all the seams are aligned for proper fit.
- Center rear headrests may have two holes in the back of the cover. Feed the posts through these holes before proceeding.

## Headrest Removal

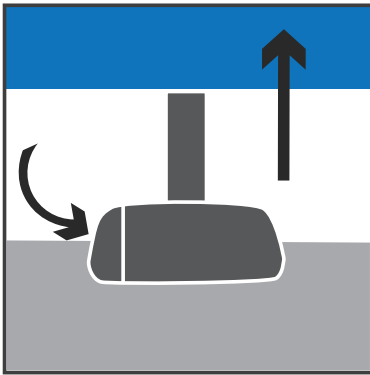

### Tab Removal

- Push in tab on guide post while lifting the headrest.
- Repeat on the opposite side if applicable.

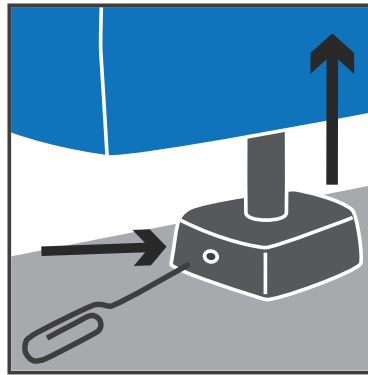

### Pin Hole Removal

- Insert a paperclip end or small allen key into the pin hole.
- While pressing the tool in, lift the headrest.
- Repeat on the opposite side if applicable.

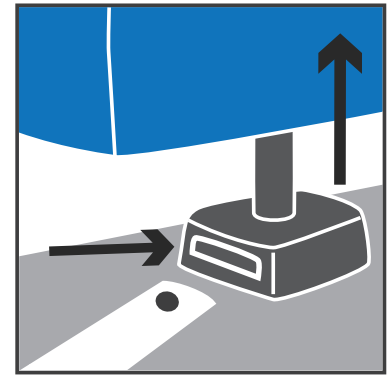

### Slot Removal

- Press into the slot with provided install tool or finger while lifting headrest.
- Repeat on opposite side if applicable.

### Tips

- Headrests may have a combination of removal methods (tab & pin, tab & slot, pin & slot).
- Some headrests may require assistance to remove.
- Some headrests have tricks to finding the removal method.
  - Check to see if your headrest folds forward and has pin holes on the back.
  - Push down fabric around posts to check for hidden plastic guide posts.
- If you do not see any of the above methods for removal, check the seat back section of your covers for an opening in the top of cover.

## Bucket, Captains Chair, & 40/20/40 Backrest Installation

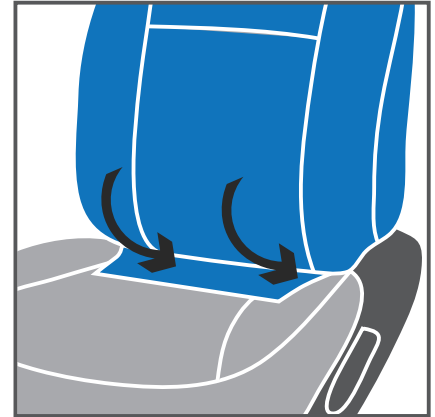
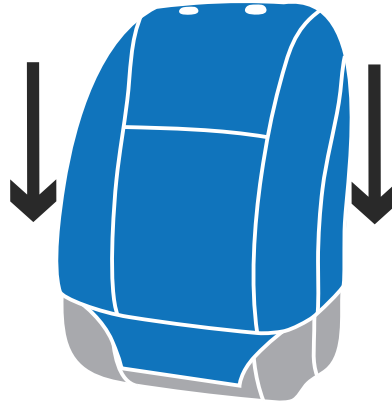
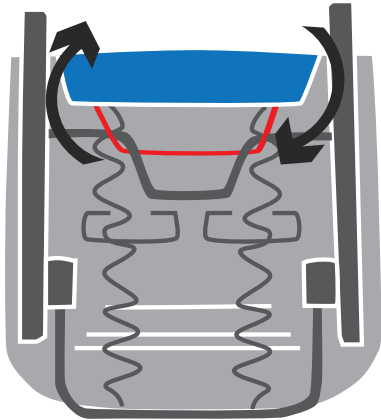

### Backrest Bottom Flap

- Find the elastic strap(s) at the edge of the flap.
- Unhook the elastic loop or plastic clip.
- Reattach the strap(s) and attach the flap on the cover with velcro or elastic cords once the installation is complete.

### Installation

- Match cutouts in the cover with any headrest guides, armrests, and levers.
- Airbag tags (newer models) and openings (older models) will face the door.
- Smooth the cover down over the seat.

- Push the flap through the gap between the backrest and bottom.
- Ensure all the seams are aligned for proper fit.

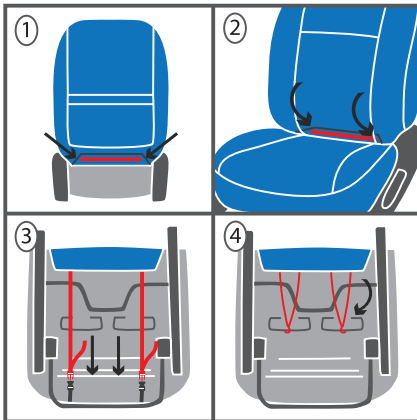

### Attachment Methods

1. Hook velcro to the back of the cover.
2. Hook velcro to the bottom cover.
3. Buckle straps to the bottom cover.
4. Hook elastic shock cord under the seat.

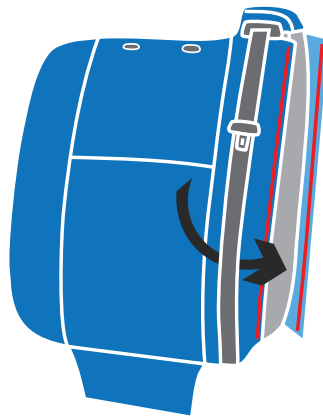

### Integrated Seatbelt

- Open velcro side closure on cover and pass the front of the cover underneath the seatbelt before closing the velcro again and proceeding with the installation.

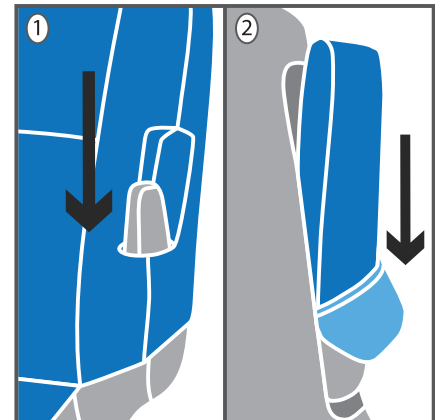

### Integrated Armrest

1. While pulling seat back cover down, pull the armrest through.
1. Tuck the material of the cover in around the armrest.
2. Put the armrest cover on halfway inside out, then unroll the rest of the way down.

### Tips

- The covers may be tight and cling to your seat. Ease them on gradually.
- If you are struggling to put the cover on try turning the cover half inside out, positioning the top and rolling the cover the rest of the way down.
- Alternatively a flexible piece of plastic, like the bag the covers came in, can be placed between the cover and the seat to decrease friction. Remove plastic after installation is complete.

## Bucket, Captains Chair, & 40/20/40 Bottom Installation

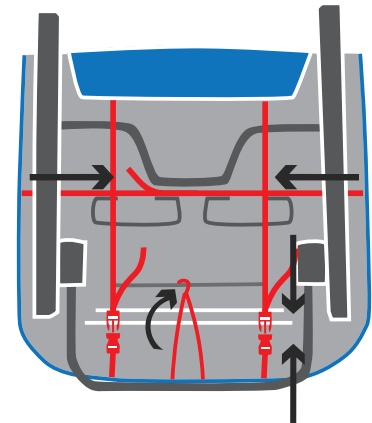
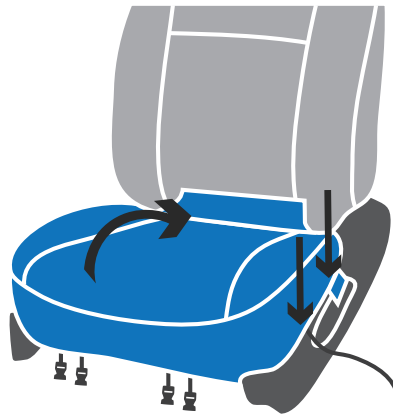
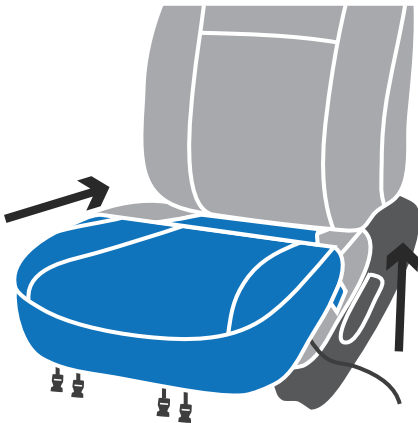

### Installation

- Slide the cover over the front of the seat, lining up the seams at the front edge of the seat with the cover.
- Smooth the cover back to the gap between the backrest and bottom.
- Push the flap through.
- Tuck the sides of the cover into any plastic trim.
- Push any velcro straps, anchor flaps, or anchor tabs between the plastic trim and the seat.
- Buckle straps front to back.
- Connect velcro straps side to side.
- Hook any elastic shock cord straps to the underside of the seat.

### Tips

- Attach the velcro at the beginning of the flap to the velcro on the backrest cover if present.
- If the bottom cover seems too short to cover the areas closest to the backrest, try smoothing and pulling the cover towards the back more.
- Some covers may have velcro tabs that hook to the carpet on the bottom of the seat.

## 40/20/40 Center Console Installation

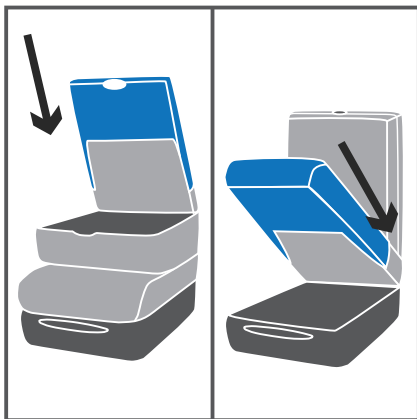

### Opening Lid & Bottom Installation

- Slide lid and bottom covers on, feeding the latches through the provided cutouts.
- Attach any velcro tabs to carpet and hook any straps present together.

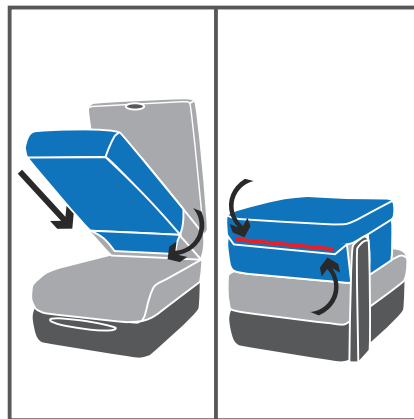

### Opening Backrest Installation

- Slide and smooth cover on.
- Attach any velcro straps across to hold it in place.
- Attach the velcro edge on the backrest cover to the velcro edge on the lid cover.

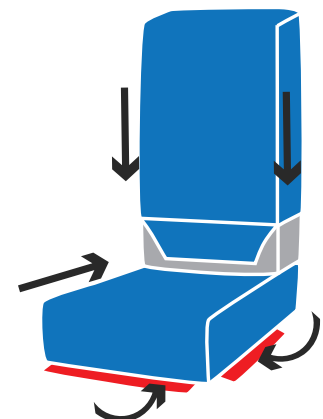

### Non-Opening Installation

- Slide and smooth the top and bottom covers on.
- Attach velcro tabs on bottom cover to the carpet.
- Attach velcro closure together at the back of the top section.

## Split & Solid Bench Seatback Installation

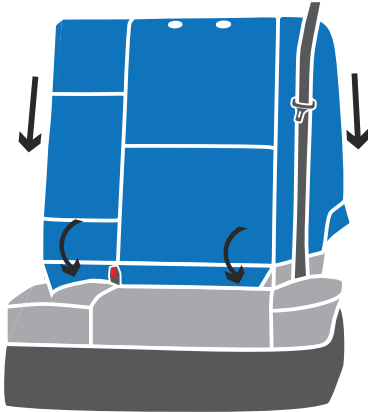

### Installation

- Slide the cover over the seat, lining up the seams and smoothing as you go.
- Tuck the cover in around any headrest posts, levers, or openings.
- Push the flap between the seatback and bottom.

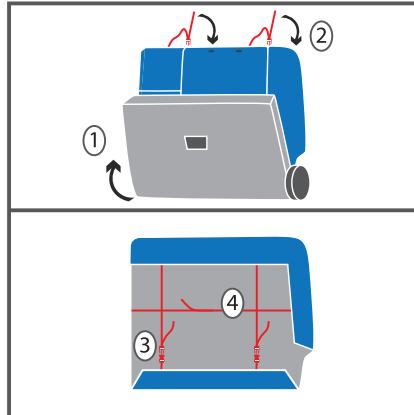

### Truck Style

1. Lift the bottom of the seat to get more room behind the backrest.
2. Pass the straps at the top of the cover over the back.
3. Connect straps from the top to straps at the bottom.
4. Hook velcro straps together across the back.

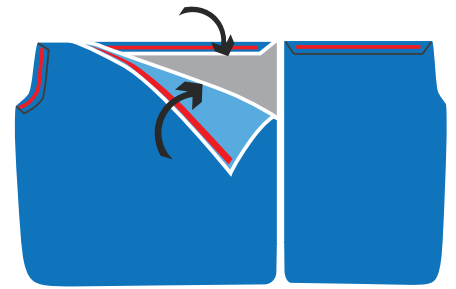

### Car/SUV Style

- Fold seatback forward.
- Connect the velcro closure at the bottom (and sides if present) of the cover.
- Hook any short velcro straps to the carpet on the back of the seat.

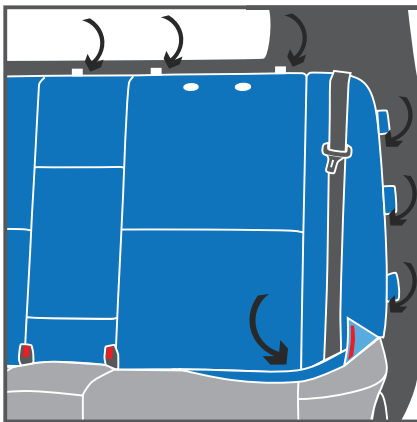

### Hybrid Style

- Tuck in any anchor flaps or anchor tabs into the gaps between the seat and the rest of the vehicle.
- Attach any velcro tabs to carpet
- Hook any elastic shock cord to structural elements (not wires) behind the seat.

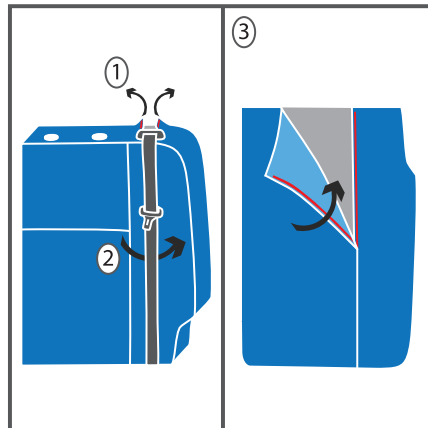

### Integrated Seatbelt

1. Open velcro closure on back or side if present.
2. Slide the cover underneath the seatbelt before proceeding with installation.
3. Reattach velcro and tuck cover in around the seat belt guides.

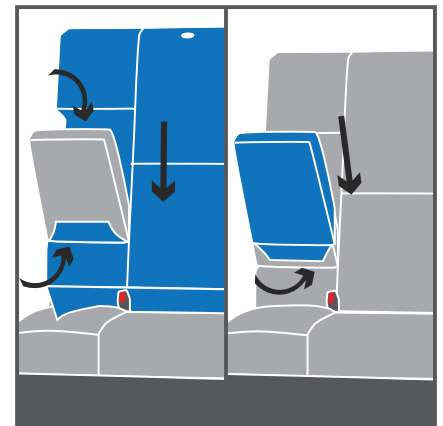

### Center Armrest Installation

- Pull the armrest slightly out while putting cover on and put it through the opening in the cover.
- Tuck in anchor flaps/tabs or attach the velcro behind the armrest.
- Slide armrest on and attach velcro.

### Tips

- The backrest cover will always go underneath the seat belts.
- Moving the armrest up and down can help push the armrest cover into place.
- Tucking the cover in around any plastic trim will give the seat a more polished look.

## Split & Solid Bench Bottom Installation

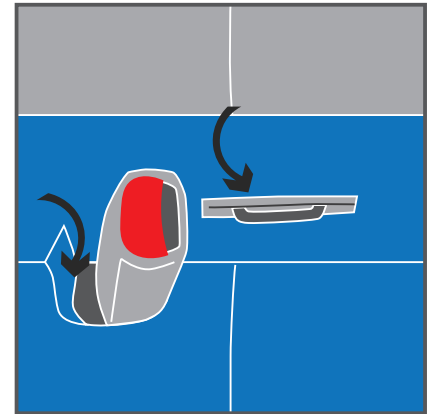
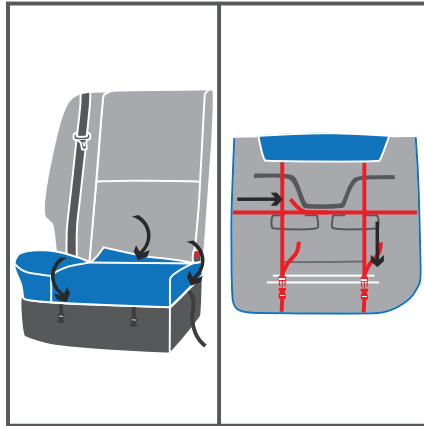
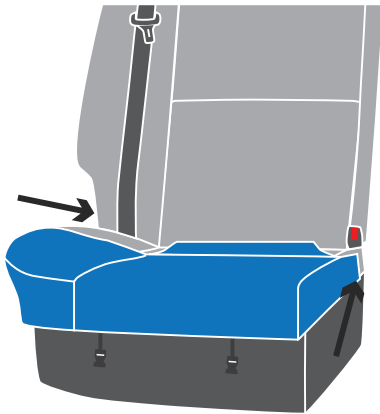

### Split Bottom Installation

- Slide the cover over the front of the seat, lining up the seams at the front edge of the seat with the cover.
- Smooth the cover back to the gap between the backrest and bottom.
- Push the flap through.
- Tuck the sides of the cover into any plastic trim.
- Push any velcro straps, anchor tabs, or anchor flaps between the plastic trim and the seat.
- Attach any straps or velcro under the seat.

### Seat Belts & Child Seat Anchors

- Tuck in any flaps around seat belts.
- Covers will have openings to accommodate child seat anchors.
- Pull any straps at the openings for the child seat anchors through.

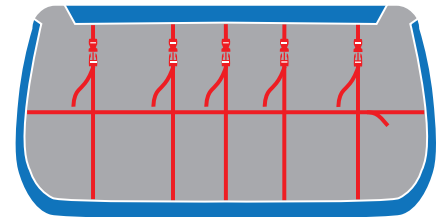
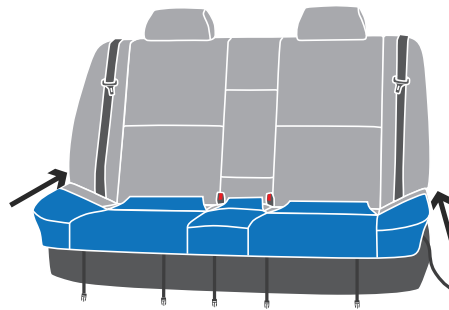
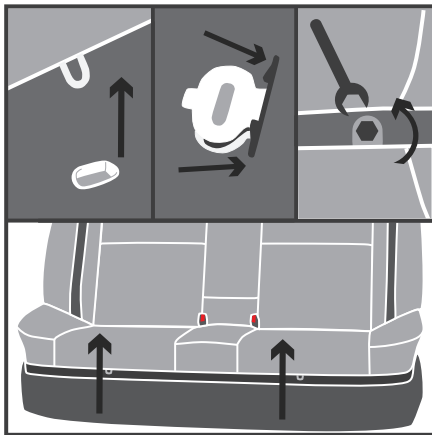

### Seat Bottom Removal (if applicable)

- Look for any plastic tabs at the base of the seat.
- Pull or push in tabs and lift seat.
- If there are no plastic tabs jerk the seat up hard from the front edge.
- One retaining bolt may be located at the back.

### Solid Bottom Installation

- Remove the seat from the vehicle if necessary.
- Slide the cover onto the seat, lining up seams and smoothing as you go.
- Tuck in the cover around any seatbelt openings and into any plastic trim.
- Buckle the straps from the back to front under the seat.
- Connect the velcro straps from the sides under the seat.
- Replace seat if necessary while making sure the seatbelts are pulled back through.

### Tips

- If the bottom cover seems too short to cover the areas closest to the backrest, try smoothing and pulling the cover towards the backrest.
- Some covers may have velcro tabs that hook to the carpet on the bottom of the seat.

## Bolster Installation

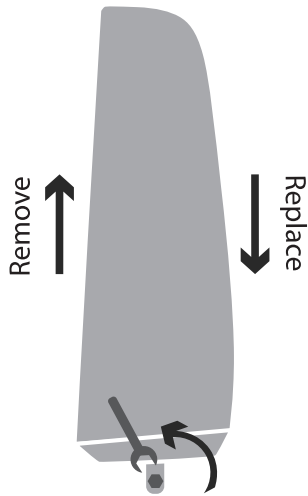

### Bolster Removal (if applicable)

- After removing the seat bottom, a single bolt will be revealed.
- Remove the bolt and lift up.
- Install the cover.
- To reinstall, insert the top first and slide down.

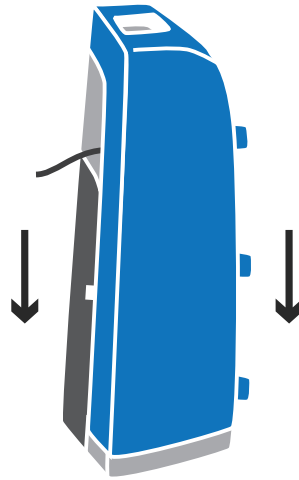

### Bolster Installation

- Remove seatbelt from the plastic guide if applicable.
- Smooth the cover on, lining up seams as you go.

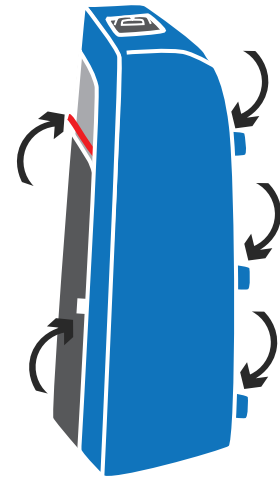

- Connect any straps.
- Tuck anchor flaps and/or anchor tabs between the seat and the plastic framing.
- Hook any velcro to original material.
- Replace seatbelt in guide.

## Care

Vacuum regularly to remove debris. Spot wash with a damp cloth. Use material specific cleaners for stains.

**WARNING:** Machine wash and dry cycles can potentially damage the foam backing on your covers.

If you encounter any problems during the installation of your Seat Cover, please contact our Customer Service Department, Monday - Friday, 8AM - 5PM (MST) at 866-755-6005 or by e-mail at [pfsales@covercraft.com](mailto:pfsales@covercraft.com). You may also access help videos on the web at <https://www.covercraft.com/us/en>.