

# GUWA<sup>®</sup>

Powered by  **GU AUTO TECH** INC.

**“Bringing together inspired functionality and industry-leading technology. GU Auto Tech creates leading edge solutions with style and precision. Always striving to give you the best.”**

**[www.guautotech.com](http://www.guautotech.com) | [contact@guautotech.com](mailto:contact@guautotech.com)**

**Fax: (213) 377-5166 | Office: 1(800)844-5995**

**19500 S Rancho Way, Suite 106 Rancho Dominguez, CA 90220**

**We bring you the GUA 10.4" Large Touch Screen Installation manual for your Ford Mustang.**

Tools Required:

- **7mm Socket and Socket Wrench**
- **Plastic, Auto Trim Pry Tool**

Please follow our Step by step installation guide, as explained below:

**Step #1** - Remove Dash Trim by pulling/prying.  
The piece is held on with plastic clips so it can be pulled off with some force.

**Step #2** - Remove the two covers below the switches.  
Use a pry tool to release clips.



**NEED ASSISTANCE? PLEASE CONTACT THE GUA TEAM TODAY.**

If you have any questions, please do not hesitate to get in touch with us.

\*Please note: All the instructions in this Manual was right and created for the sole purpose to assist buyers of this product to install this to their vehicle. We do not take any responsibility for any harm, damages or loss caused when installing this product. T's & C's Apply.

Please follow our Step by step installation guide, as explained below:

**Step #3** - Remove the kick panels on either side of the console. They will release by pulling/prying on them. Remove driver side and passenger side.

**Step #4** - Remove the 7mm screws under the kick panels on both sides. Having this piece loose will help remove/install the screen components.

**Step #5** - Remove the 7mm screws above the screen, and the two 7mm below the switches.

**Step #6** - Remove the Stock bezel. You may need to **push the side column pieces away from the bezel to remove it.** Disconnect any electrical connections as you remove the bezel.

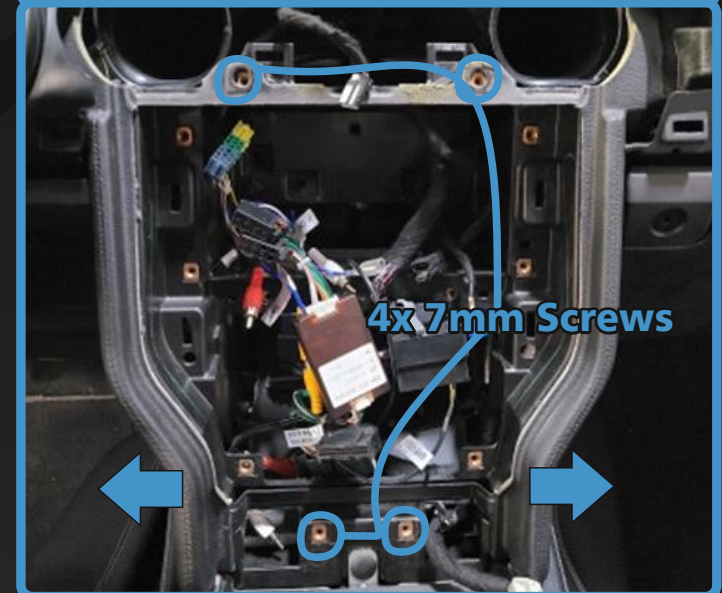
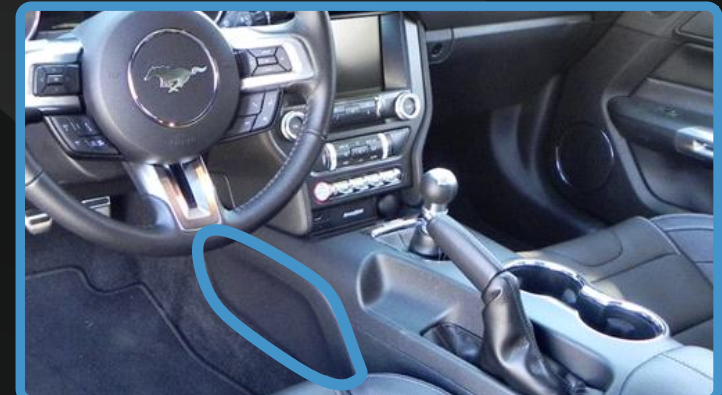

Please follow our Step by step installation guide, as explained below:

**Step #7** - With the Bezel removed, now you can remove the four 7mm screws from the screen and the four 7mm screws from the CD Player.

**Step #8** - Remove the Screen and the CD Player from the vehicle. Disconnect the electrical connections as you go.

**Step #9** - Install the supplied GUA Harness other components.

**Note:** There will be some connections that are not used, depending on your vehicles features.



**For the detailed GUA Harness diagrams, please  
page over to see these diagrams. > > > >**

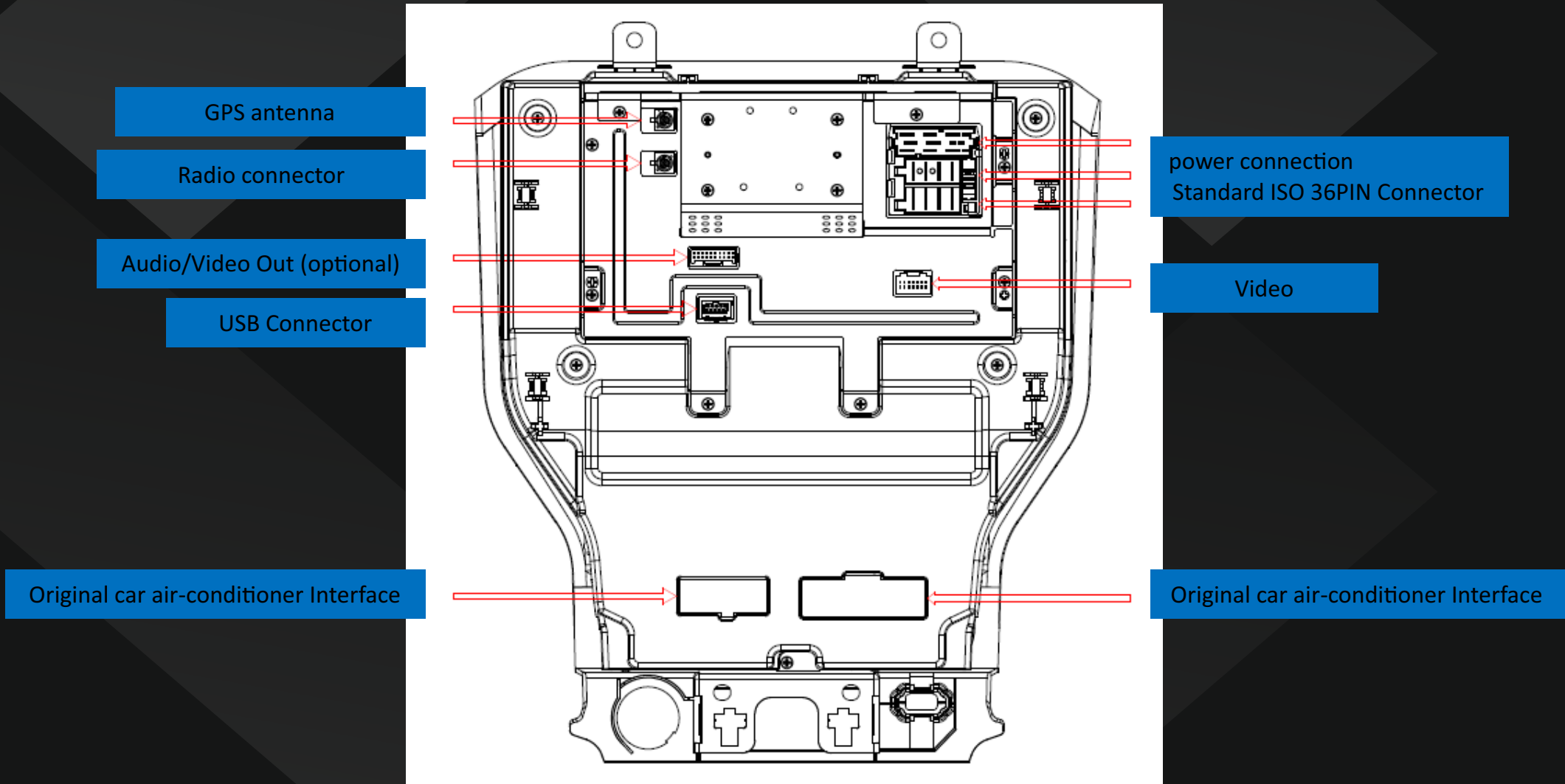

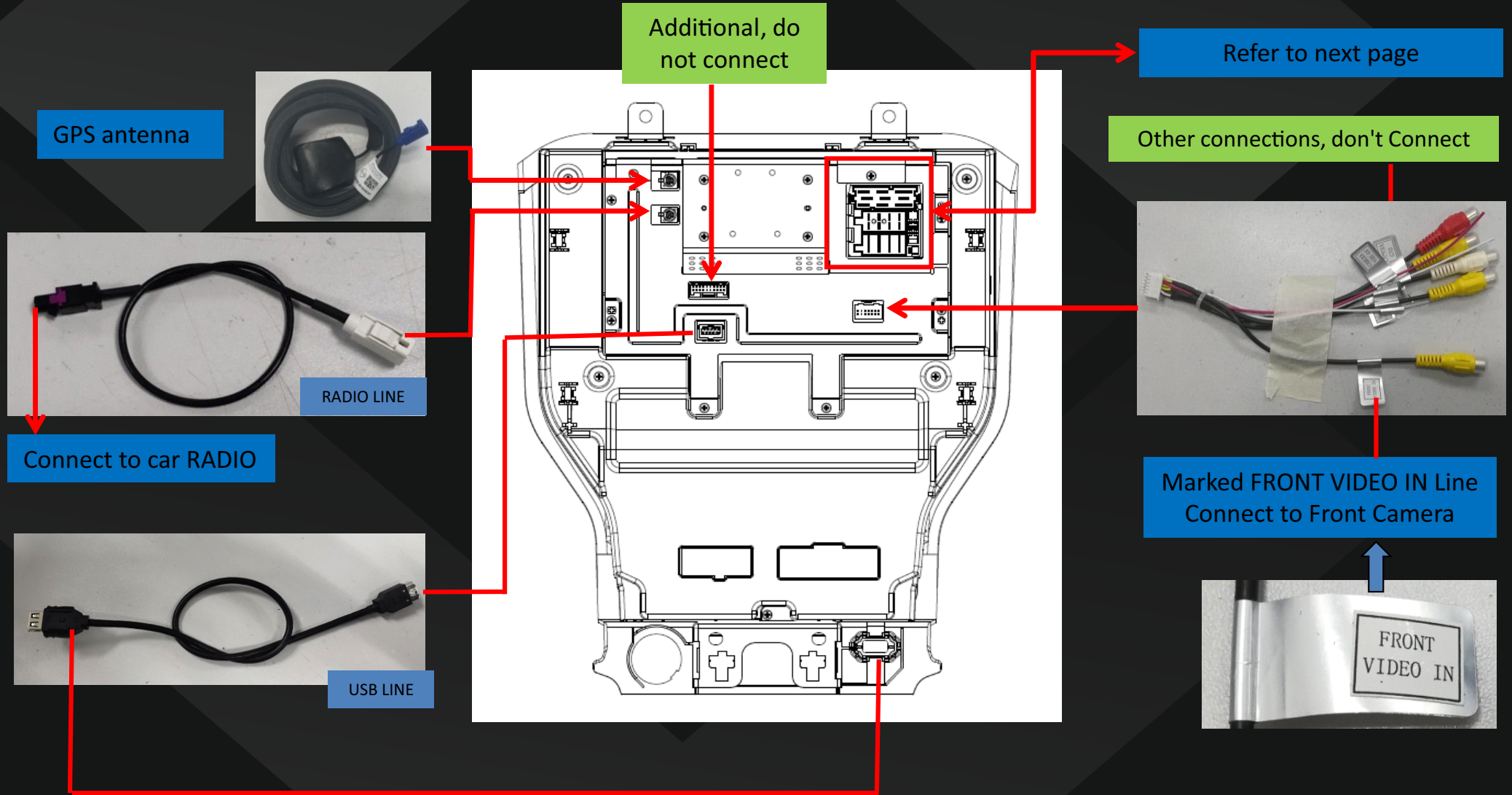

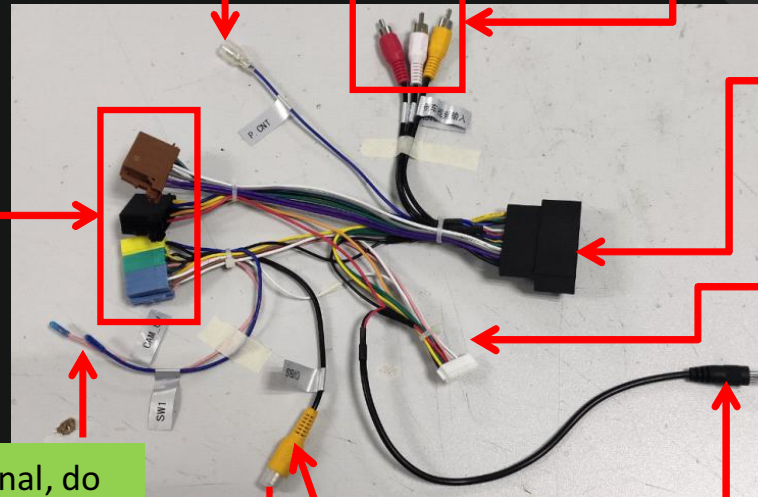
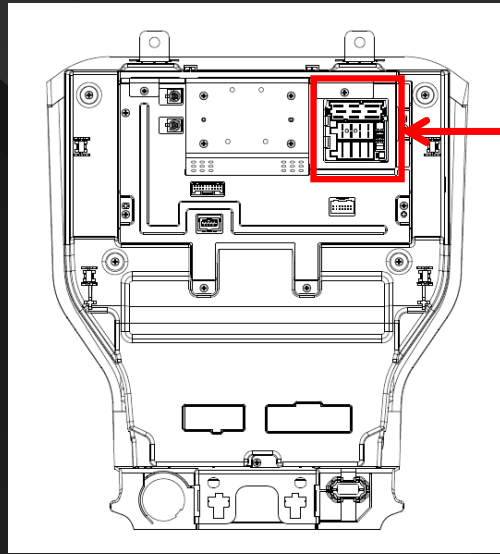

Only sony power AMP need to connect this

Additional, do not connect

To car original connector



Additional, do not connect

Reverse camera input

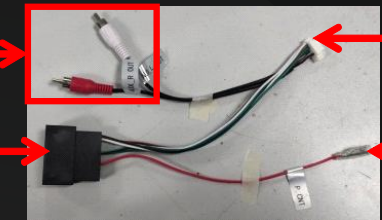

To car original connector



Power for Front camera

To car original connector

Additional, do not connect

To car original connector, either-or



Powered by  GU AUTO TECH<sup>INC.</sup>

## GUA Ford Mustang Large 10.4" Screen Installation Guide:

Please follow our Step by step installation guide, as explained below:

**Step #10** - Before tightening all the screws and reinstalling trim; Double check all the electrical connectors are attached and then start your vehicle to test the screen is operating properly.

**Step #11**- If operating properly, now reinstall all the trim and tighten all screws.

**Step #12** - Go to: <https://www.guautotech.com/gua-product-warranty-registration> and register your unit so you can stay up to date with all the newest software updates and information.

**Thank you for your support.** We look forward to hearing from you and your feedback on our product, to improve our features and to provide the ultimate in car experience.



Powered by  GU AUTO TECH<sup>INC.</sup>

# "THANK YOU!"