



# 1960-63 Chevrolet Pickup

*without* Factory Air  
Gen 5 Evaporator Kit  
(751583)



18865 Goll St. San Antonio, TX 78266  
Phone: 800-862-6658  
Sales: [sales@vintageair.com](mailto:sales@vintageair.com)  
Tech Support: [tech@vintageair.com](mailto:tech@vintageair.com)  
[www.vintageair.com](http://www.vintageair.com)



www.vintageair.com

# Table of Contents

Cover.....	1
Table of Contents.....	2
Packing List/Parts Disclaimer.....	3
Information Page.....	4
Wiring Notice.....	5
Engine Compartment Disassembly, Condenser Assembly and Installation, Compressor and Brackets.....	6
Passenger Compartment.....	7
Firewall Modification.....	8
Fresh Air Cover Installation, Heater Cover Installation.....	9
Lubricating O-rings, Properly Seated O-ring Land, Evaporator Preparation.....	10
Evaporator Preparation (Cont.).....	11
Evaporator Preparation (Final), Evaporator Installation & Passenger Compartment Wiring.....	12
Evaporator Installation & Passenger Compartment Wiring (Cont.).....	13
Drain Hose Installation, A/C Hose Installation.....	14
A/C Hose Installation (Cont.).....	15
Heater Hose & Heater Control Valve Installation.....	16
Dash Louver Adapter Preparation.....	17
Control Panel Installation, Engine Compartment Wiring.....	18
Engine Compartment Wiring (Cont.).....	19
Final Steps: Installation Check.....	20
Glove Box Installation, Final Steps: Completing the Install.....	21
Duct Hose Routing.....	22
Quality Crimp Guideline.....	23
Gen 5 Wiring Diagram.....	24
Gen 5 Wiring Connection Instruction.....	25
Operation of Controls.....	26
Troubleshooting Guide.....	27
Troubleshooting Guide (Cont.), Advanced Diagnostics and Troubleshooting Guide.....	28
Packing List.....	29

## Additional Information

- This kit was developed using 1960 and 1966 Chevy C-10 trucks.
- Some photos may show slight differences in firewalls, firewall cover plates, or specific bracket mounting holes due to the options or years shown.
- These vehicles were equipped with either Deluxe or Standard heaters.
- These vehicles may not be equipped with an "ACC" position on the ignition switch and may require the "keyed on power" to be connected to a "run" position source. Refer to factory wiring diagrams for your vehicle.



www.vintageair.com

## Packing List: Evaporator Kit (751583)

No.	Qty.	Part No.	Description
1.	1	765225	Gen 5 Magnum Max Module with 444 ECU
2.	1	791583	Accessory Kit

**\*\* Before beginning installation, open all packages and check contents of shipment. Please report any shortages directly to Vintage Air within 15 days. After 15 days, Vintage Air will not be responsible for missing or damaged items.**

1



Gen 5 Magnum Max  
Module with 444 ECU  
765225

2

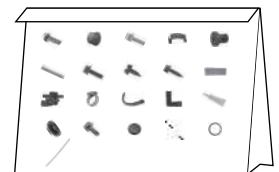
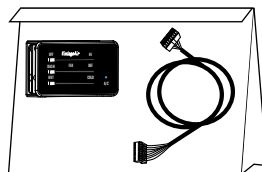
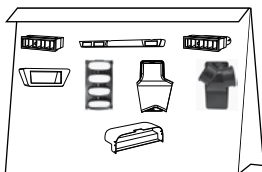
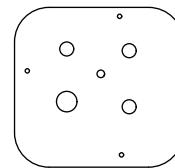
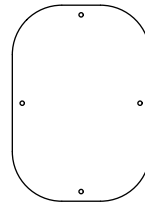
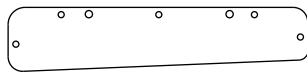
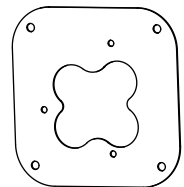
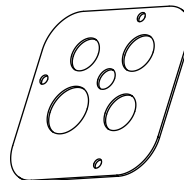
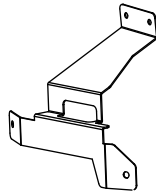
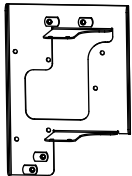
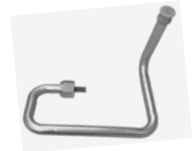

Accessory Kit  
791583

**NOTE: Images may not depict actual parts and quantities. Refer to packing list for actual parts and quantities.**



www.vintageair.com

## Important Notice—Please Read

*For Maximum System Performance, Vintage Air Recommends the Following:*

**NOTE:** Vintage Air systems are designed to operate with R134a refrigerant only. Use of any other refrigerant could damage your A/C system and/or vehicle, and possibly cause a fire, in addition to potentially voiding the warranties of the A/C system and its components.

### Refrigerant Capacities:

**Vintage Air System:** 1.8 lbs. (28.8 oz.) or 816 grams of **R134a**, charged by weight with a quality charging station or scale. **NOTE: Use of the proper type and amount of refrigerant is critical to system operation and performance.**

**Other Systems:** Consult manufacturer's guidelines.

### Lubricant Capacities:

**New Vintage Air-Supplied Sanden Compressor:** No additional oil needed (Compressor is shipped with proper oil charge).

**All Other Compressors:** Consult manufacturer (Some compressors are shipped dry and will need oil added).

### Safety Switches

Your Vintage Air system is equipped with a binary pressure safety switch. A binary switch disengages the compressor clutch in cases of extreme low pressure conditions (refrigerant loss) or excessively high head pressure (406 PSI) to prevent compressor damage or hose rupture. A trinary switch combines Hi/Lo pressure protection with an electric fan operation signal at 254 PSI, and should be substituted for use with electric fans. Compressor safety switches are extremely important since an A/C system relies on refrigerant to circulate lubricant.

### Service Info:

**Protect Your Investment:** Prior to assembly, it is critical that the compressor, evaporator, A/C hoses and fittings, hardlines, condenser and receiver/drier remain capped. Removing caps prior to assembly will allow moisture, insects and debris into the components, possibly leading to reduced performance and/or premature failure of your A/C system. This is especially important with the receiver/drier.

Additionally, when caps are removed for assembly, **BE CAREFUL!** Some components are shipped under pressure with dry nitrogen.

**Evacuate the System for 35-45 Minutes:** Ensure that system components (Drier, compressor, evaporator and condenser) are at a temperature of at least 85°F. On a cool day, the components can be heated with a heat gun **or** by running the engine with the heater on before evacuating. Leak check and charge to specifications.

### Bolts Passing Through Cowl and/or Firewall:

To ensure a watertight seal between the passenger compartment and the vehicle exterior, for all bolts passing through the cowl and/or firewall, Vintage Air recommends coating the threads with silicone prior to installation.

### Heater Hose (not included with this kit):

Heater hose may be purchased from Vintage Air (Part#31800-VUD) or your local parts retailer. Routing and required length will vary based on installer preference.



www.vintageair.com

## Important Wiring Notice—Please Read

*Some vehicles may have had some or all of their radio interference capacitors removed. There should be a capacitor found at each of the following locations:*

- 1. On the positive terminal of the ignition coil.**
- 2. If there is a generator, on the armature terminal of the generator.**
- 3. If there is a generator, on the battery terminal of the voltage regulator.**

Most alternators have a capacitor installed internally to eliminate what is called “whining” as the engine is revved. If whining is heard in the radio, or just to be extra cautious, a radio interference capacitor can be added to the battery terminal of the alternator.

It is also important that the battery lead is in good shape and that the ground leads are not compromised. There should be a heavy ground from the battery to the engine block, and additional grounds to the body and chassis.

If these precautions are not observed, it is possible for voltage spikes to be present on the battery leads. These spikes come from ignition systems and charging systems, and from switching some of the vehicle’s other systems on and off. Modern computer-operated equipment can be sensitive to voltage spikes on the power leads, which can cause unexpected resets, strange behavior and/or permanent damage.

Vintage Air strives to harden our products against these types of electrical noise, but there is a point where a vehicle’s electrical system can be degraded so much that nothing can help.

Radio interference capacitors should be available at most auto and truck parts suppliers. They typically are cylindrical in shape, a little over an inch long and a little over a half-inch in diameter, and they have a single lead coming from one end of the cylinder with a terminal on the end of the wire, as well as a mounting clip which is screwed into a good ground on the vehicle. The specific value of the capacitance is not too significant in comparison to ignition capacitors that are matched with the coil to reduce pitting of the points.

- Care must be taken, when installing the compressor lead, not to short it to ground. The compressor lead must not be connected to a condenser fan or to any other auxiliary device. Shorting to ground or connecting to a condenser fan or any other auxiliary device may damage wiring or the compressor relay, and/or cause a malfunction.
- When installing ground leads on Gen 5 systems, the blower control ground and ECU ground must be connected directly to the negative battery post.
- For proper system operation, the heater control valve must be connected to the ECU.



www.vintageair.com

## Engine Compartment Disassembly

**NOTE:** Before starting the installation, check the function of the vehicle (horn, lights, etc.) for proper operation, study the instructions, illustrations, photos & diagrams.

**Perform the following:**

1. Disconnect the battery.
2. Drain the radiator.
3. Remove radiator (retain).
4. Remove the OEM heater blower assembly and OEM heater hoses (discard) (See Figure 1, below).

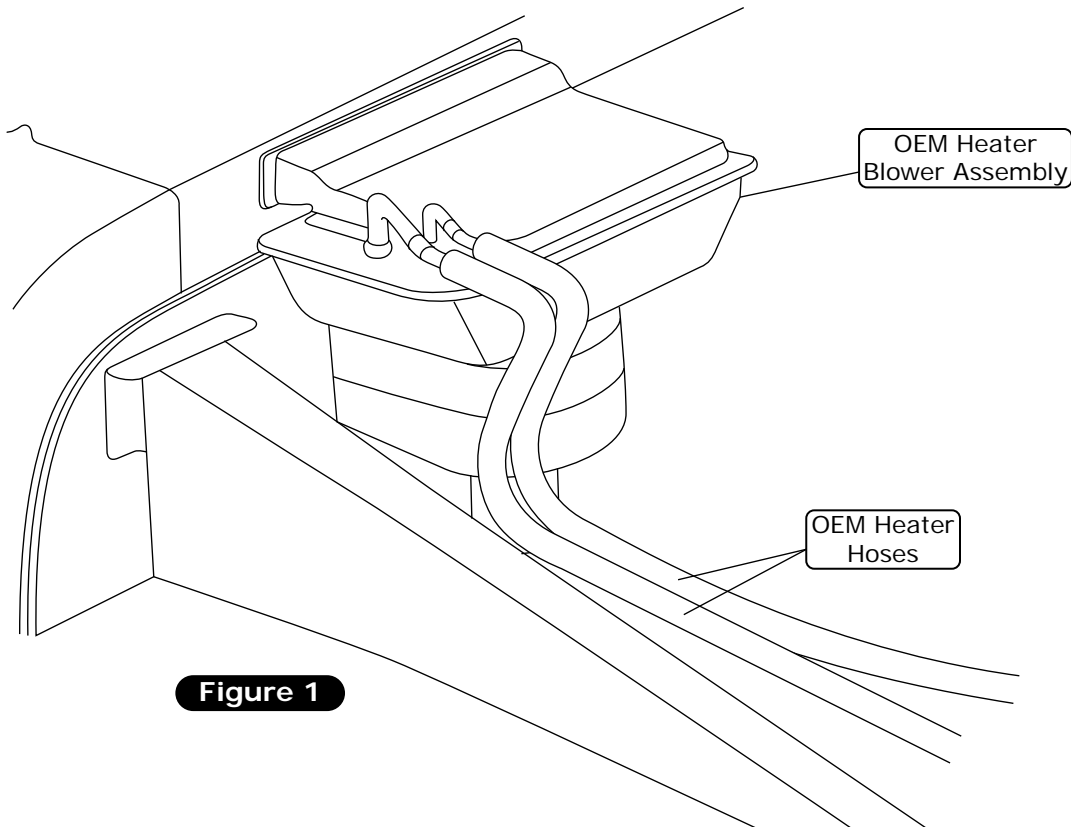

## Condenser Assembly and Installation

1. Refer to separate instructions included with the condenser kit to install the condenser.
2. Binary switch installation (Refer to condenser instructions).

## Compressor and Brackets

1. Refer to separate instructions included with the bracket kit to install the compressor bracket.



www.vintageair.com

## Passenger Compartment Disassembly

### Perform the following:

1. Remove the glove box door (retain).
2. Remove the glove box (discard).
3. Disconnect all the wires and cables from the OEM control panel (retain).
4. Remove the OEM control panel assembly (retain).
5. Remove the OEM duct hoses from defrost ducts (See Figure 1, below).
6. Remove the OEM heater assembly (discard).
7. Remove the passenger-side fresh air door assembly (discard) (retain screws) (See Figure 1a, below).

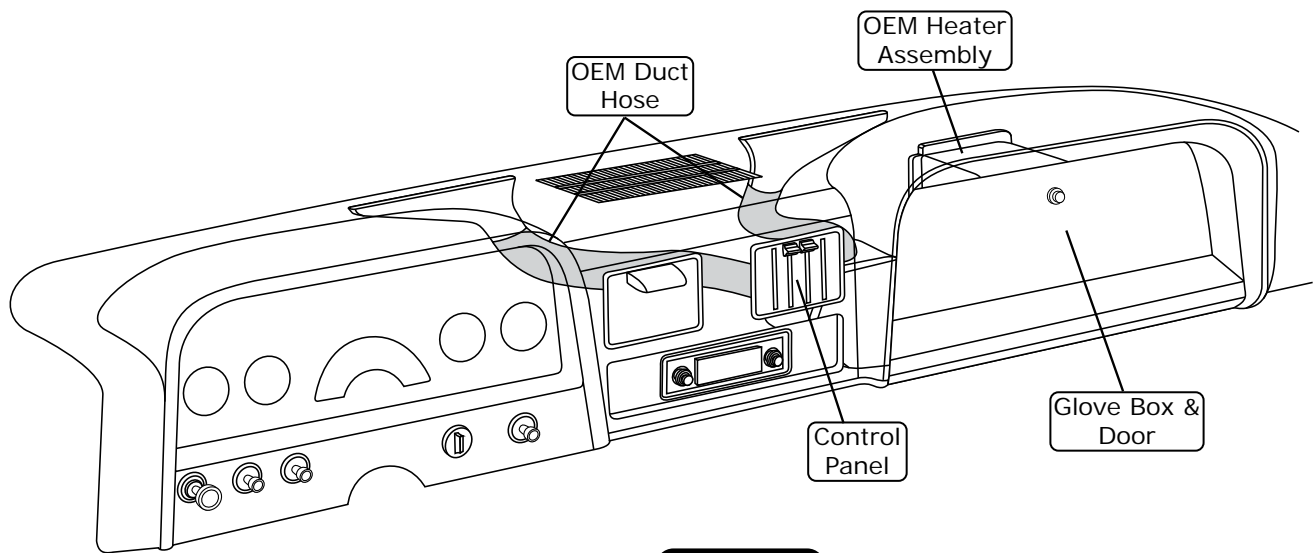

**Figure 1**

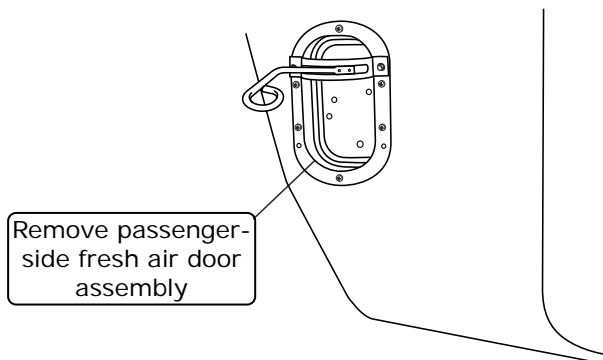

**Figure 1a**



www.vintageair.com

## Firewall Modification

**NOTE:** For proper system operation, Vintage Air recommends replacing factory firewall insulation with Dynaliner (461500-VIP) or equivalent 1/8"-1/4" insulation.

1. Measure 12" from the kick panel and 3" up from the floor pan to the firewall transition, then drill a 5/8" hole for the drain hose (See Photo 1, below).
2. Drill out any unused holes to 1/2" or 1" and use the provided plastic plugs to cover them as shown in Photo 2, below.

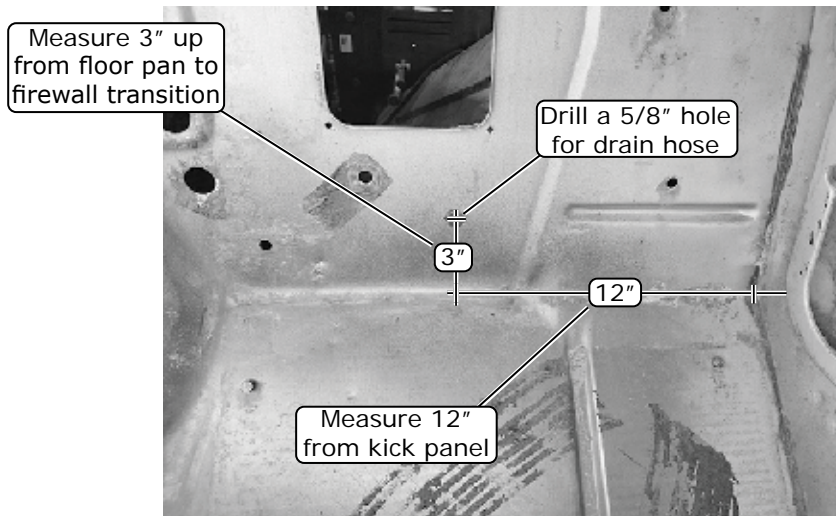

Photo 1

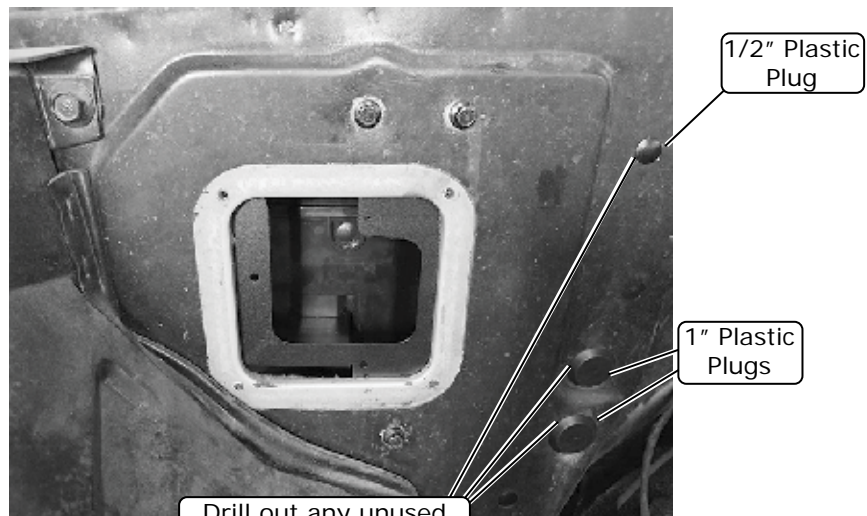

Photo 2



www.vintageair.com

## Fresh Air Cover Installation

1. Install the fresh air cover onto the kick panel using (2) #10 x 1/2" sheet metal screws at the top and bottom position (See Photo 1, below).
2. Using the fresh air cover as a template, drill both side holes into the kick panel (See Photo 1, below).
3. Remove the fresh air cover and apply silicone to the mating surface (See Photo 2, below).
4. Install the fresh air cover using (4) #10 x 1/2" sheet metal screws (See Photo 3, below).

Fresh Air Cover  
640060

Install fresh air cover onto kick panel using (2) #10 x 1/2" sheet metal screws

Apply silicone

Install fresh air cover using (4) #10 x 1/2" sheet metal screws

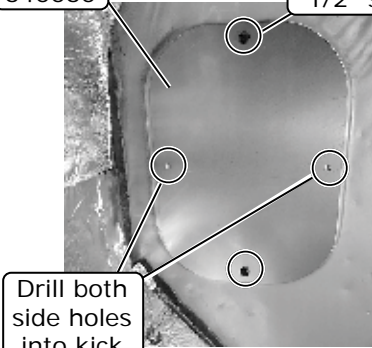

Photo 1

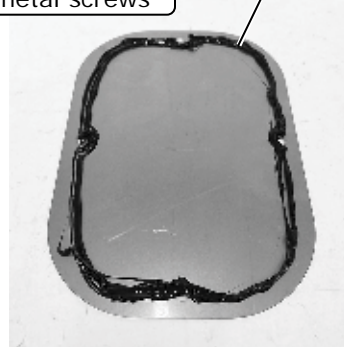

Photo 2

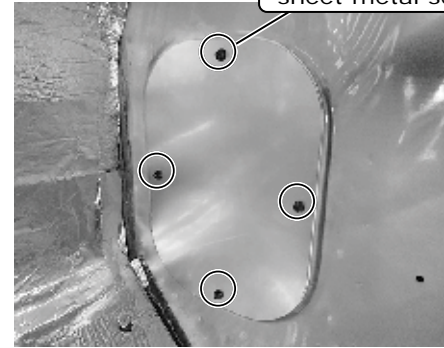

Photo 3

## Heater Cover Installation

1. Depending if the vehicle was equipped with deluxe or standard heater, there may be an opening or existing plate as shown in Photo 1, below.
2. Original plate (if equipped) can be left on, otherwise, apply silicone to the mating surface of the heater cover bracket.
3. Install the heater cover bracket using (5) #14 x 3/4" washer head screws (See Photo 2, below).
4. Apply silicone to the mating surface of the large firewall cover and install it using (4) #14 x 3/4" washer head screws (See Photo 3, below).

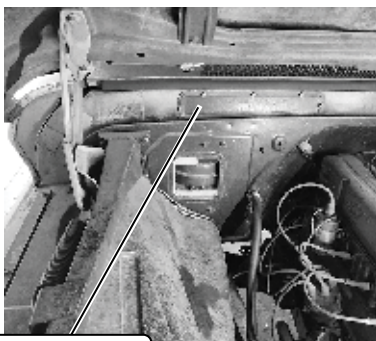

Photo 1

Heater Cover Bracket  
644092

Install heater cover bracket using (5) #14 x 3/4" washer head screws

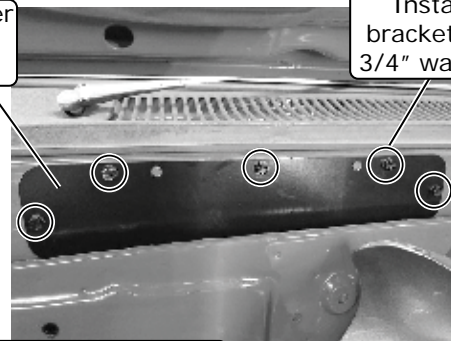

Photo 2

Depending if vehicle was equipped with deluxe or standard heater, there may be an opening or existing plate

Install large firewall cover using (4) #14 x 3/4" washer head screws

Large Firewall Cover  
644059

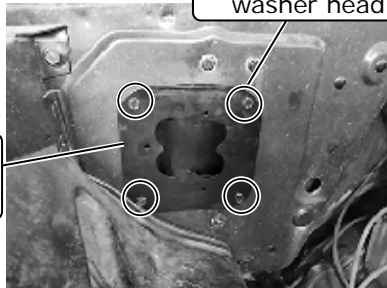
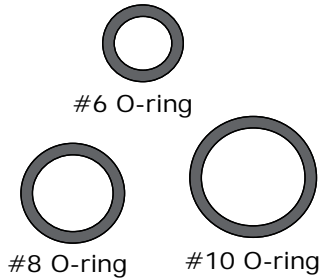

Photo 3



www.vintageair.com

## Lubricating O-rings



**NOTE: Standard torque specifications:**  
#6: 11 to 13 ft.-lb.  
#8: 15 to 20 ft.-lb.  
#10: 21 to 27 ft.-lb.

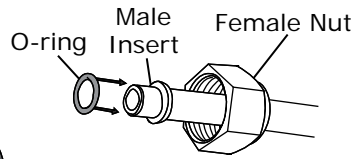

For a proper seal of fittings: Install supplied O-rings as shown and lubricate with refrigerant oil.

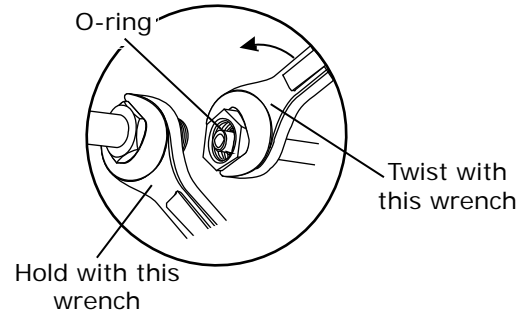
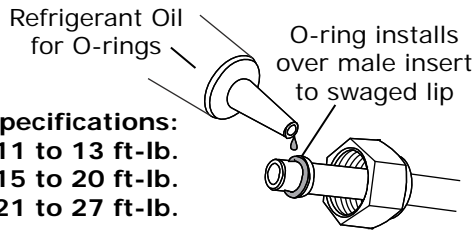

## Properly Seated O-ring Land

When installing a hardline or A/C hose fitting onto the evaporator module, ensure the O-ring land is seated properly (See Photo 1, below). An improperly seated O-ring land (See Photo 2, below) can cause a leak. To properly install the fitting, slide the hardline or A/C hose nut back to expose the O-ring land and seat it onto the evaporator module fitting. Then, slide the hardline or A/C hose nut forward and thread it onto the evaporator module fitting, ensuring the O-ring land does not move or lift.

Properly Seated O-ring Land



Photo 1

Improperly Seated O-ring Land



Photo 2

**NOTE:** Photos shown are for reference only. Fittings may vary depending on kit received.

## Evaporator Preparation

**NOTE:** Ensure hardlines are aligned before fully tightening. Use a back-up wrench when tightening fittings. For all mounting provisions not being used, install the supplied caps.

Perform the following on a workbench:

1. Remove the heater caps (See Photo 1, below). **NOTE:** Heater core should be pressurized.
2. With a properly lubricated #10 O-ring (See Lubricating O-rings, above), install the shorter heater hardline onto the lower fitting (See Photo 2, below). Leave loose.

Remove heater caps

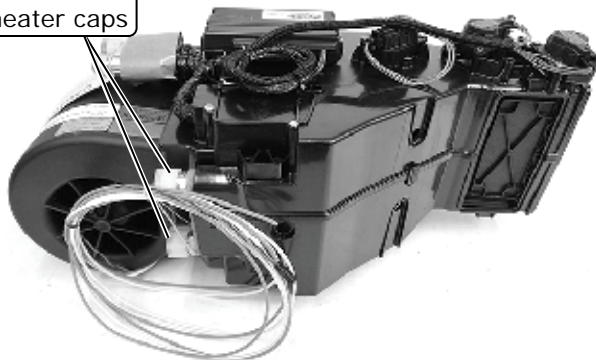

Photo 1

Install shorter heater hardline onto lower fitting

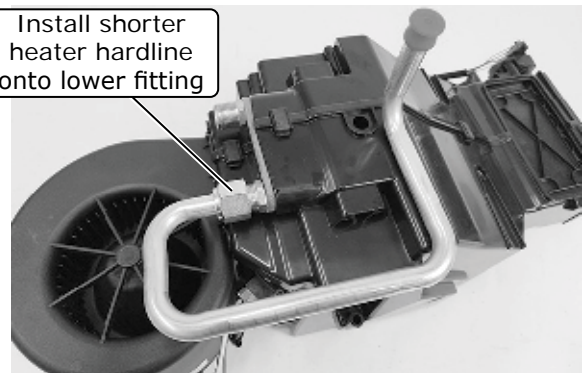

Photo 2



www.vintageair.com

## Evaporator Preparation (Cont.)

3. With a properly lubricated #10 O-ring (See Lubricating O-rings, Page 10), install the longer heater hardline onto the evaporator module upper fitting (See Photo 3 below). Leave loose.
4. Ensure that the hardlines are flat against the module and the ends are parallel with each other. Using a backup wrench, fully tighten both heater hardline fittings once properly aligned.
5. Install (3) 1/2" plastic plugs into the back of the evaporator module (See Photo 4, below). **NOTE: These mounting provisions will not be used in this application.**
6. Using (4) #10 x 5/8" screws, secure the rear evaporator bracket onto the evaporator (See Photos 5 and 6, below).
7. Using (2) 1/4-20 well-nuts and (2) 1/4-20 x 1" serrated flange bolts, secure the front evaporator bracket to the front of the evaporator module as shown in Photos 7 and 8, below.
8. Using (4) spring clips, install the dash plenum as shown in Photos 9 below.
9. Using (2) spring clips, install the floor plenum onto the front of the evaporator as shown in Photo 10, below.
10. Using (2) spring clips, install the defrost plenum onto the rear of the evaporator as shown in Photo 11, below.

Install longer heater hardline onto upper fitting

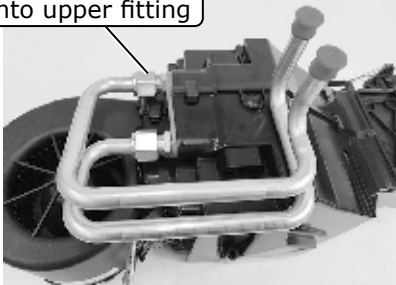

Photo 3

Install (3) 1/2" plastic plugs into back of evaporator module

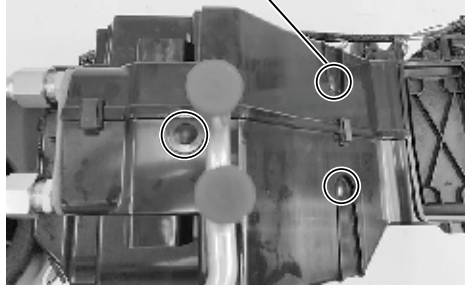

Photo 4

(2) #10 x 5/8" Screws

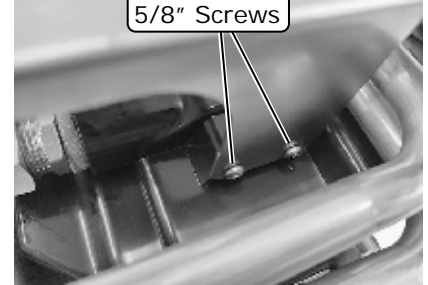

Photo 5

(2) #10 x 5/8" Screws

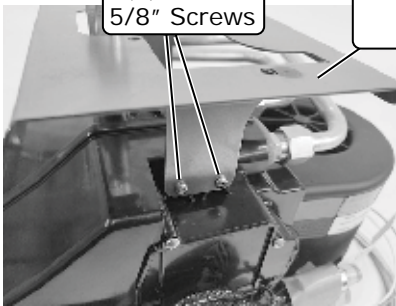

Photo 6

Rear Evaporator Bracket 640055

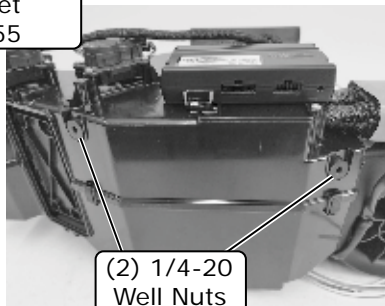

Photo 7

(2) 1/4-20 Well Nuts

Front Evaporator Bracket 640057

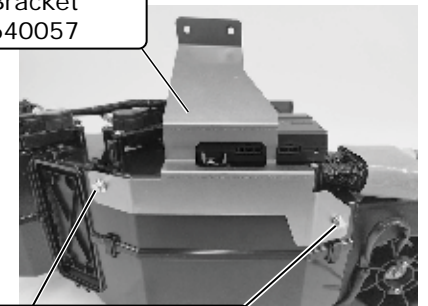

Photo 8

(2) 1/4-20 x 1" Serrated Flange Bolts

Dash Plenum 625330

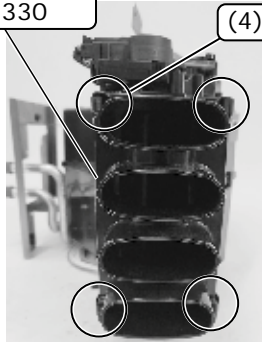

Photo 9

(4) Spring Clips

Floor Plenum 625340

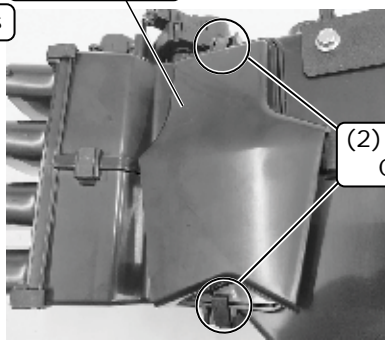

Photo 10

(2) Spring Clips

(2) Spring Clips

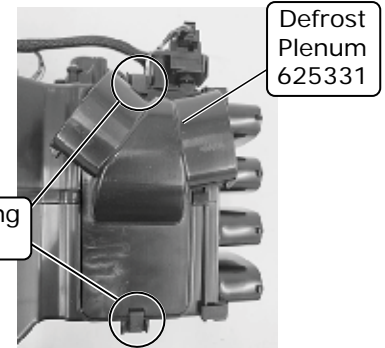

Photo 11

Defrost Plenum 625331



www.vintageair.com

## Evaporator Preparation (Final)

11. Install (2) 1/4-20 full-threaded studs into the rear evaporator bracket as shown in Photo 12, below.

(2) 1/4-20 Full-Threaded Studs

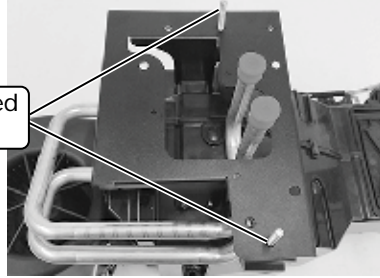
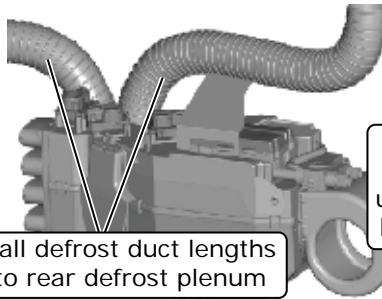

Photo 12

## Evaporator Installation & Passenger Compartment Wiring

1. Bring the evaporator module into the vehicle.
2. Install the defrost duct lengths onto the rear defrost plenum according to Duct Hose Routing, Page 22 (See Photo 1, below). **NOTE: Image for reference only.**
3. Carefully lift the module into place, aligning the lower studs with the upper and lower holes in the firewall (See Photo 2, below).
4. Ensure the evaporator module is level front to back and side to side.
5. Mark and drill pilot holes on the cowl using the front evaporator bracket holes as a template.
6. Apply silicone to the drilled holes and secure the front evaporator bracket using (2) #14 x 3/4" washer head screws (See Photo 3, below). Leave loose.
7. One at a time, remove the studs from the rear evaporator bracket and replace with (2) 1/4-20 x 3/4" serrated flange black bolts and (2) .562 O.D. x .260 I.D. nylon sleeve washers (See Photo 4, below). Install a third 1/4-20 x 3/4" serrated flange black bolts and a .562 O.D. x .260 I.D. nylon sleeve washer into the upper right hole (See Photo 4, below).
8. Verify module is level and tighten both #14 x 3/4" washer head screws (See Photos 5 and 6, below).



Install defrost duct lengths onto rear defrost plenum

Photo 1

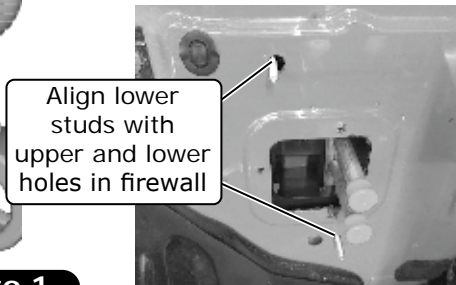

Align lower studs with upper and lower holes in firewall

Photo 2

Secure front evaporator bracket using (2) #14 x 3/4" washer head screws



Photo 3

(3) 1/4-20 x 3/4" serrated flange black bolts and (3) .562 O.D. x .260 I.D. nylon sleeve washers

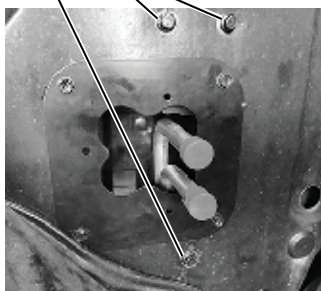
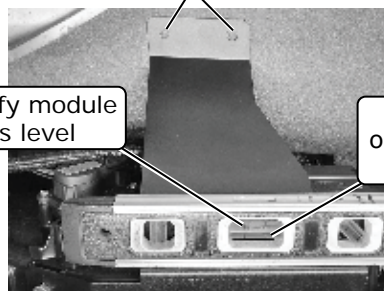

Photo 4

Tighten both screws



Verify module is level

Photo 5

Check for level on flat portions of module

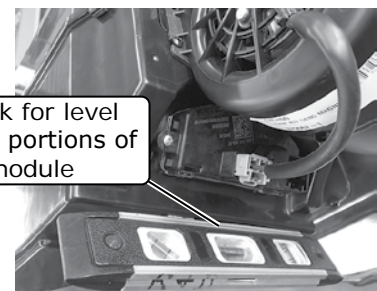

Photo 6



www.vintageair.com

## Evaporator Installation & Passenger Compartment Wiring (Cont.)

9. Select a suitable location for the main relay, then secure it using a #12 x 1/2 self-tapping screw (See Photo 7, below).
10. Select a suitable ground location for the white ground wire eyelet from the heater control valve harness, then secure it using a #12 x 1/2" self-tapping screw (See Photo 7, below).
11. Route the violet and tan wires towards the driver side of the cab along the back of the dash.
12. Route the violet wire to the OEM fuse panel and connect it to a fused, key-on ignition source.
13. Route the tan wire towards the gauges and connect to a lights-on source for the control panel backlight.
14. Connect the green and red wire connectors together (See Photo 8, below).
15. Plug in the main wiring harness into the ECU (See Photo 9, below).
16. Plug the control panel harness into the ECU and route it towards the control panel opening (See Photo 9, below).
17. Route the remaining wires out through the opening of the firewall (See Photo 10, below).
18. Install the rubber boot and the standard firewall cover, pulling the wires through the small holes in the center of the rubber boot and standard firewall cover (See Photo 11, below).
19. Secure the standard firewall cover using (3) #14 x 3/4" washer head screws (See Photo 12, below).

Secure main relay using a #12 x 1/2" self-tapping screw

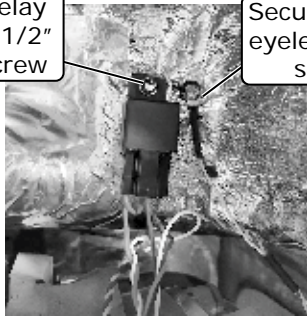

**Photo 7**

Secure white ground wire eyelet using a #12 x 1/2" self-tapping screw

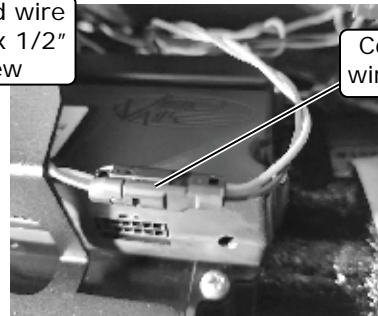

**Photo 8**

Connect green and red wire connectors together

Plug in main wiring harness into ECU

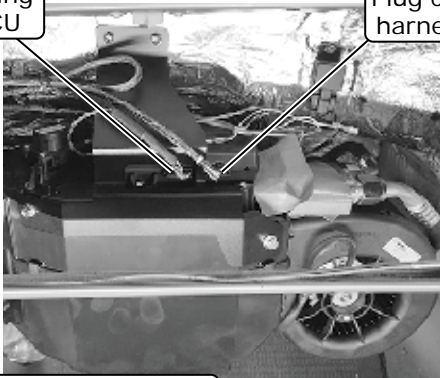

**Photo 9**

Plug control panel harness into ECU

Route remaining wires out through opening of firewall



**Photo 10**

Pull wires through small holes in center of rubber boot and standard firewall cover

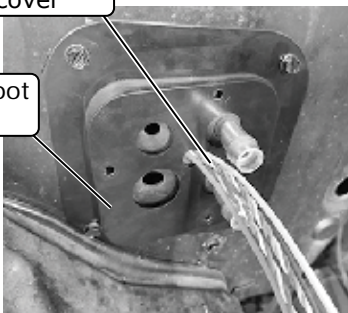

**Photo 11**

Rubber Boot 338641

Standard Firewall Cover 640058

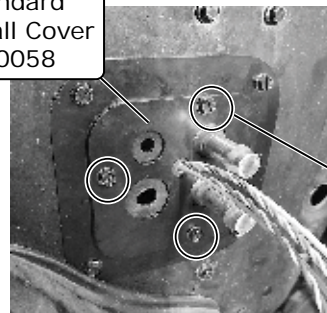

Secure firewall cover using (3) #14 x 3/4" washer head screws

**Photo 12**



www.vintageair.com

## Drain Hose Installation

1. Cut the drain hose into 10" and 5" lengths (See Photo 1, below).
2. Attach the 10" length of drain hose to the evaporator module drain nipple (See Photo 2, below).
3. Install the hose through the previously drilled hole in the firewall (See Photo 2, below).
4. Install the drain elbow onto the 5" length of hose.
5. Inside the wheel well, attach the drain elbow and short piece of hose to the drain hose exiting the firewall (See Photo 3, below).

Drain Hose  
31050-VUD

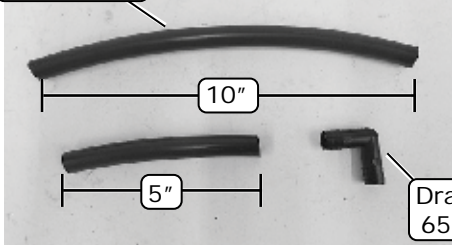

Photo 1

Attach 10" length drain hose to  
evaporator module drain nipple



Photo 2

Attach drain elbow and short piece  
of hose to drain hose exiting  
firewall



Photo 3

## A/C Hose Installation

1. Feed the 45° fitting of the #10 compressor/evaporator A/C hose from the engine compartment to the passenger compartment, through the rubber boot (See Photo 1, below).
2. Feed the 90° fitting of the #6 drier/evaporator A/C hose from the engine compartment to the passenger compartment, through the rubber boot (See Photo 2, below).
3. Route both hoses behind the evaporator and up toward the top of the module, toward the block fitting (See Photo 3, below).
4. Remove the caps from the block fittings.

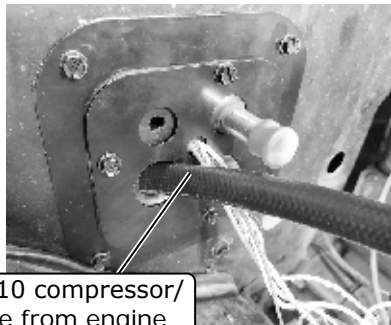

Feed 45° fitting of #10 compressor/  
evaporator A/C hose from engine  
compartment to passenger  
compartment, through rubber boot

Photo 1



Feed 90° fitting of #6 drier/  
evaporator A/C hose from  
engine compartment to  
passenger compartment,  
through rubber boot

Photo 2

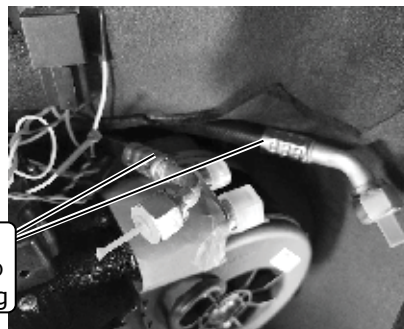

Route both hoses behind  
evaporator and up toward  
top of module, toward block fitting

Photo 3



www.vintageair.com

## A/C Hose Installation (Cont.)

5. With a properly lubricated O-ring (See Lubricating O-rings, Page 10), connect the #6 A/C hose to the evaporator block fitting (See Photo 4, below).
6. With a properly lubricated O-ring (See Lubricating O-rings, Page 10), connect the #10 A/C hose to the evaporator block fitting (See Photo 4, below).
7. With a properly lubricated O-ring (See Lubricating O-rings, Page 10), connect the #6 A/C hose to the condenser hardline (See Photo 5, below).
8. With properly lubricated O-rings (See Lubricating O-rings, Page 10), connect the #8 A/C hose from the compressor to the #8 condenser hardline (See Photos 5 and 6, below).
9. With a properly lubricated O-ring (See Lubricating O-rings, Page 10), connect the #10 A/C hose to the compressor (See Photo 6, below).
10. Secure the #6 and #10 A/C hoses to the fender well using a 3/4" ID Adel clamp, 10-32 x 1/2" pan head screw and a 10-32 nut with star washer (See Photo 7, below).
11. Secure the #8 A/C hose to the #10 A/C hose using tie wraps.
12. At the evaporator, wrap the #10 45° fitting with press tape (See Photo 8, below).

Connect #6 A/C hose to evaporator block fitting

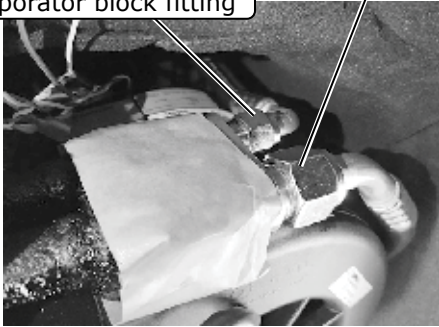

Connect #10 A/C hose to evaporator block fitting

**Photo 4**

Connect #6 A/C hose to condenser hardline

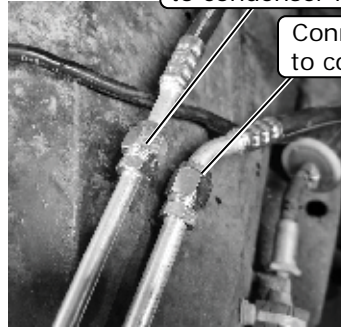

**Photo 5**

Connect #8 A/C hose from compressor to condenser hardline

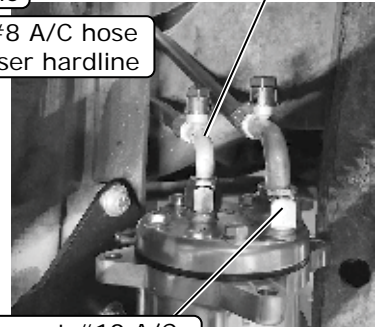

**Photo 6**

Connect #8 A/C hose to condenser hardline

Connect #10 A/C hose to compressor

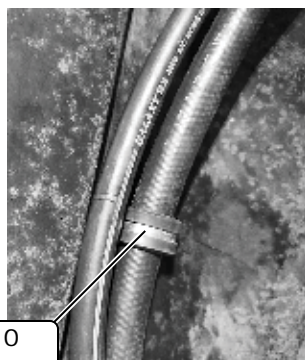

**Photo 7**

Secure #6 and #10 A/C hoses to fender well using 3/4" ID Adel clamp, 10-32 x 1/2" pan head screw and a 10-32 nut with star washer

Wrap #10 45° fitting with press tape

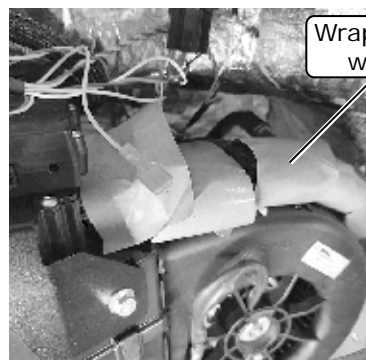

**Photo 8**



www.vintageair.com

# Heater Hose & Heater Control Valve Installation

1. Cut a 5" length of heater hose and connect it to the lower heater hose (See Photo 1, below).
2. Install the outlet of the heater control valve onto the hose (See Photo 1, below). Secure both sides with hose clamps (See Photo 1, below). **NOTE: The molded arrow on the heater control valve should point toward the firewall.**
3. Cut a length of heater hose and route it between the intake manifold and the heater control valve (See Photo 2, below). Secure both ends with hose clamps (See Photo 2, below).
4. Cut a length of heater hose and route it between the water pump and the upper heater hardline at the firewall (See Photo 2, below). Secure both ends with hose clamps (See Photo 2, below).
5. Plug the heater control valve connector into the wiring harness (See Photo 3, below).

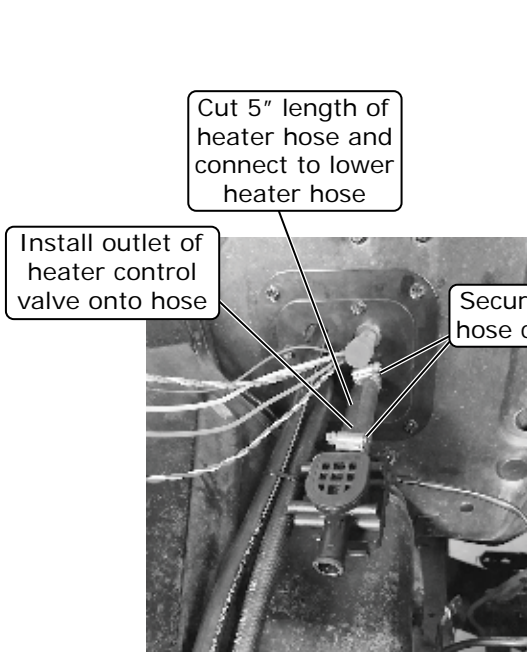

Photo 1

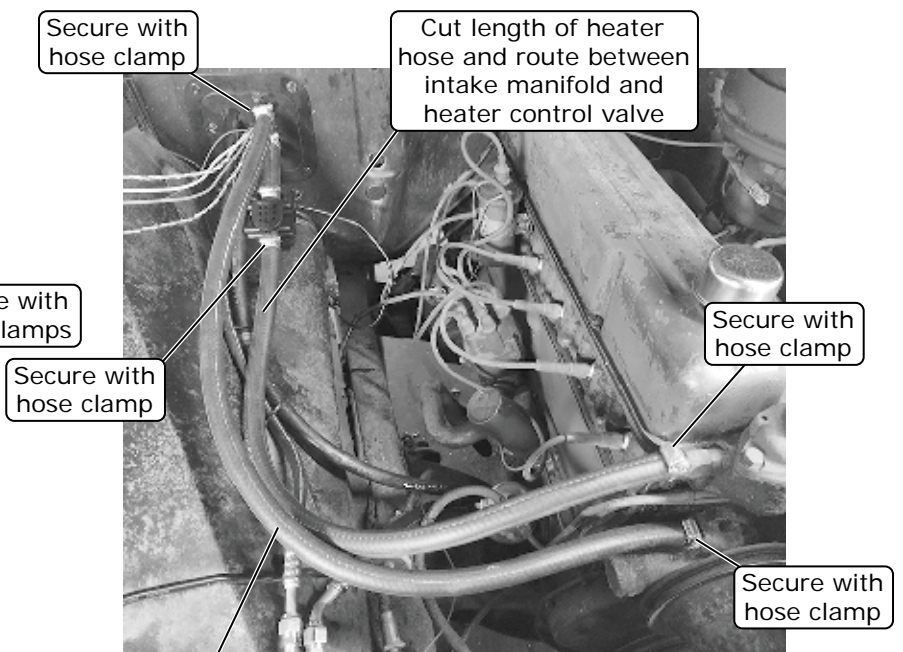

Photo 2

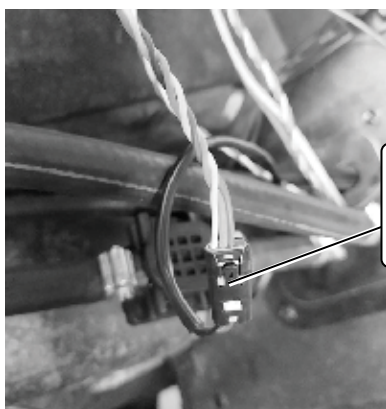

Photo 3

Cut length of heater hose and route between water pump and upper heater hardline at firewall

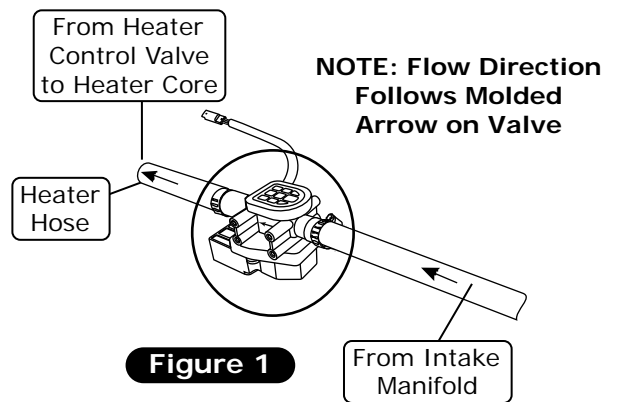

Figure 1



www.vintageair.com

## Dash Louver Adapter Preparation

### Perform the following on a workbench:

1. Place the center/passenger-side louver under the dash as shown in Photos 1 and 2, below. Mark the mounting locations.
2. Remove and predrill the dash.
3. Install the center/passenger-side louver with (3) #10 x 1/2" sheet metal screws (See Photos 1 and 2, below).
4. Place the driver-side louver bezel under the dash as shown in Photo 3, below. Mark the mounting locations.
5. Remove and predrill the dash.
6. Install the assembly with (2) #10 x 1/2" sheet metal screws (See Photo 3, below)
7. Install (5) 1/2" plastic plugs into the bottom of the louver bezels to cover the mounting holes (See Photos 5, 6 and 7, below).
8. Install the duct hoses according to the Duct Hose Routing, Page 22. **NOTE: Tie wraps are provided to secure the duct hoses up and under the dash (See Photo 4, below).**
9. Install (3) 4 3/4" x 1 1/2" without hose adapter louvers into the passenger-side and center vents (See Photos 5 and 6, below).
10. Install a 4 3/4" x 1 1/2" with 2 1/2" hose adapter louver into the driver-side vent (See Photo 7, below).

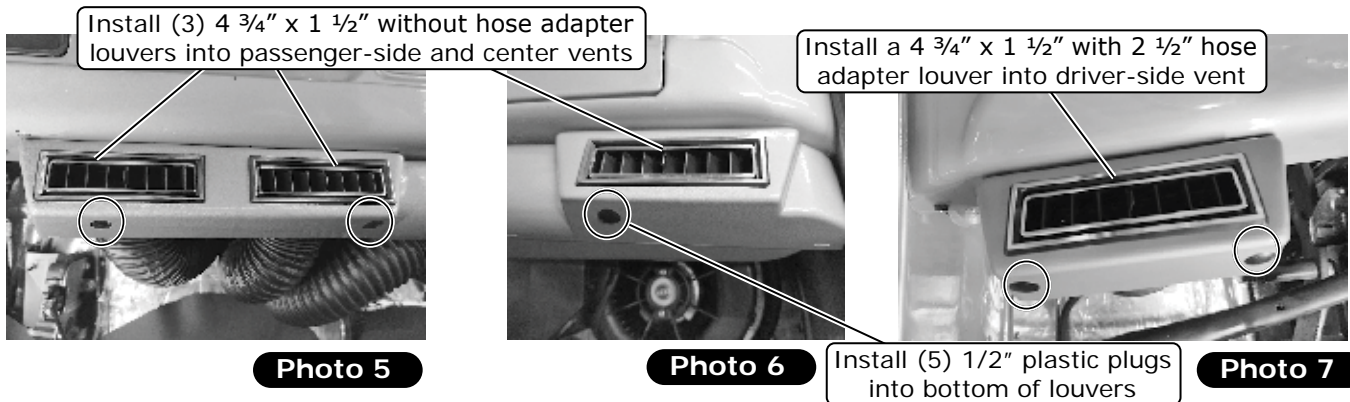
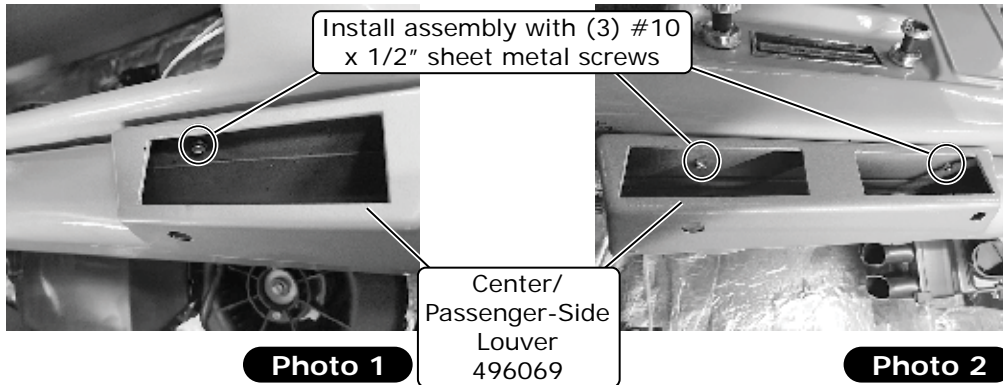



www.vintageair.com

## Control Panel Installation

1. Refer to control panel instruction for installation procedures.

## Engine Compartment Wiring

1. Route the blue wire coming from the firewall along the #6 A/C hose toward the condenser (See Photo 1, below).
2. Route wire through the grommet toward the drier.
3. Following the Quality Crimp Guidelines on Page 23, terminate the blue lead with a spade terminal and connect it to the safety switch (See Photo 2, below).
4. Connect the blue compressor lead to the compressor and route it along the #8 A/C hose. Connect it to the safety switch (See Photo 2, below).
5. Reinstall the battery tray and battery. **NOTE: Do not reconnect the battery at this time.**

Route blue wire coming from firewall along #6 A/C hose toward condenser

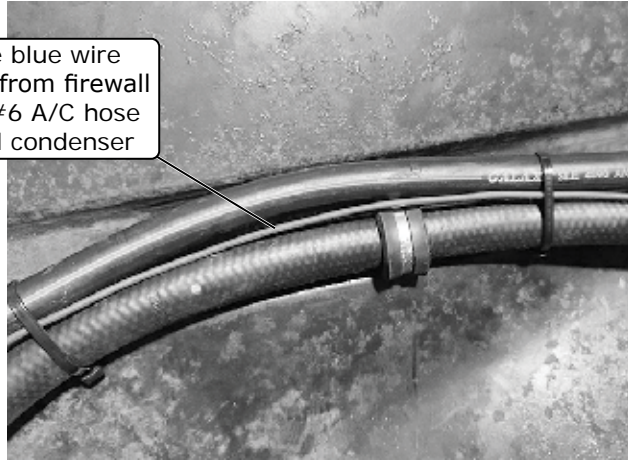

Photo 1

Terminate blue lead with a spade terminal and connect to safety switch

Connect blue compressor lead to compressor and route it along #8 A/C hose. Connect to safety switch.

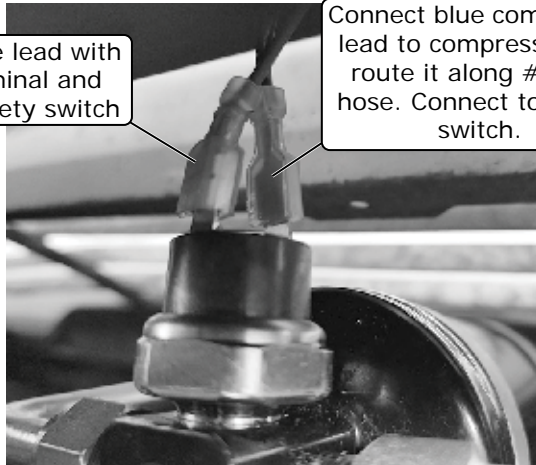

Photo 2



www.vintageair.com

## Engine Compartment Wiring (Cont.)

**NOTE:** The following connections are critical to the performance of the system. Before making connections, refer to the **Quality Crimp Guidelines, Page 23.**

6. Route power and ground wires toward the battery (See Photo 3, below).
7. Install the supplied heat shrink over the 12 AWG orange standard fuse holder assembly wire and crimp it to the 12 AWG orange wire from the main wiring harness (See Photo 4, below). Slide the heat shrink over the crimp, then apply heat.
8. Install the supplied heat shrink over the 16 AWG black mini fuse holder assembly wire and crimp it to the 16 AWG red wire from the main wiring harness (See Photo 5, below). Slide the heat shrink over the crimp, then apply heat.
9. Install the fuses into the holders (See Photos 6 and 7, below).
10. Install the supplied heat shrink over the white ground wires, then crimp on the supplied ring terminals (See Photo 8, below). Slide the heat shrink over the crimps, then apply heat. **NOTE: Both white wires can be crimped to the larger ring terminal. Install the heat shrink, then strip the wires, twist them together and trim to length. Crimp on the ring terminal, then slide the heat shrink over and apply heat (See Photos 9 and 10, below).**

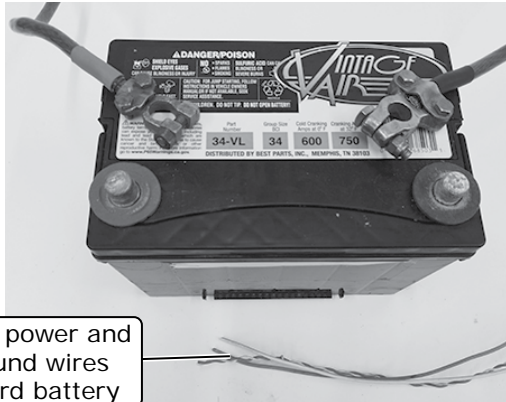

Route power and ground wires toward battery

**Photo 3**

Crimp 12 AWG orange fuse holder wire to 12 AWG orange wire from main wiring harness



**Photo 4**

Install heat shrink over 12 AWG orange standard fuse holder assembly wire

Crimp 16 AWG black fuse holder wire to 16 AWG red wire from main wiring harness



**Photo 5**

Install heat shrink over 16 AWG black standard fuse holder assembly wire

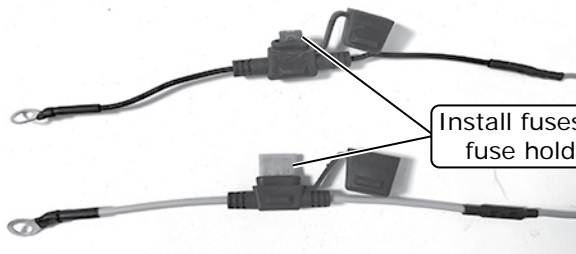

Install fuses into fuse holders

**Photo 6**

Both white ground wires can be crimped together. Install heat shrink, then strip wires, twist together and trim to length.

**Photo 7**

Install heat shrink over white ground wires, then crimp on ring terminals

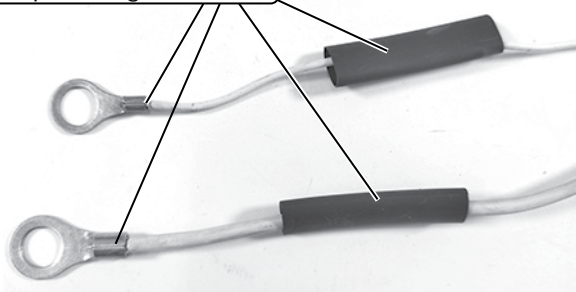

**Photo 8**

Crimp on ring terminal, then slide heat shrink over and apply heat

**Photo 9**

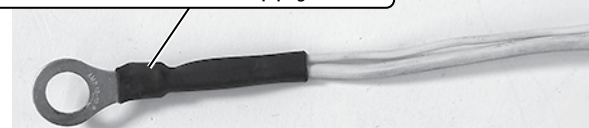

**Photo 10**



www.vintageair.com

# Final Steps: Installation Check

Installation Check	
ITEM TO CHECK	Procedure
<input type="checkbox"/>	<p>ECU</p> <p>If no blinking is observed after 1 minute of turning the ignition on, go to the next check.</p> <p>If repetitive blinking is observed, go to the <b>Advanced Diagnostics</b> Section to diagnose.</p>
<input type="checkbox"/>	<p>Blower speed control</p> <p>Set the blower speed control to <b>OFF</b>, <u>confirm that the blower is off</u>.</p> <p>Position the blower speed control to <b>LOW</b> then <b>MEDIUM</b> and then <b>HIGH</b>. <u>At each setting confirm that the blower speed increases</u>, do this by feeling for the amount of air coming from the unit and hearing the blower speed increase.</p>
<input type="checkbox"/>	<p>Mode control</p> <p>Set the <b>MODE</b> control to the <b>DASH</b> position. <u>Confirm that air is being blown at the dash vents</u>.</p> <p>Set the <b>MODE</b> control to the <b>FLOOR</b> position. <u>Confirm that air is being blown at the floor vents</u>.</p> <p>Set the <b>MODE</b> control to the <b>DEFROST</b> position. <u>Confirm that all air is being blown from the defrost vents</u></p> <p><b>If heater lines are installed:</b></p> <p>Set the <b>MODE</b> control to the <b>DASH</b> position. Set the <b>TEMP</b> control to the <b>MAX HEAT</b> position. <u>Confirm that HOT air is coming from the dash vents</u>.</p>
<input type="checkbox"/>	<p>Temperature control</p> <p><b>If system is charged:</b></p> <p>Set the <b>TEMP</b> control to the <b>MAX COOL</b> position. <u>Confirm that COLD air is coming from the dash vents</u>.</p> <p>Also <u>confirm that the compressor "clicks" on</u> when adjusting the <b>TEMP</b> control from the <b>MAX HEAT</b> position to the <b>MAX COOL</b> position.</p>
<input type="checkbox"/>	<p>AC Indicator (If applicable)</p> <p>While the <b>MODE</b> control is set to the <b>DASH</b> position, and the <b>TEMP</b> control is set to the <b>MAX COOL/MIN HEAT</b> position, <u>confirm that the blue AC Indicator light is on</u>.</p>
<input type="checkbox"/>	<p>Backlight (If applicable)</p> <p>If your control panel has backlight capabilities and has been wired, turn the dash lamp on and <u>confirm that the AC panel's legend is lit</u>.</p>
<input type="checkbox"/>	<p>Fittings</p> <p>Verify AC and Heater fittings are all tight.</p>



www.vintageair.com

## Glove Box Installation

1. Install (6) #8 U-nuts onto the glove box holes as shown in Photo 1, below.
2. Install glove box into opening (See Photo 2, below). **NOTE: Route the passenger defrost duct behind the glove box when installing (See Photo 3, below).**
3. Reinstall glove box door and secure with OEM hardware (See Photo 2, below).

Install (6) #8 U-nuts onto glove box holes

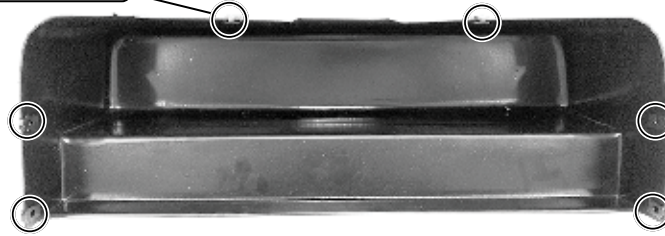
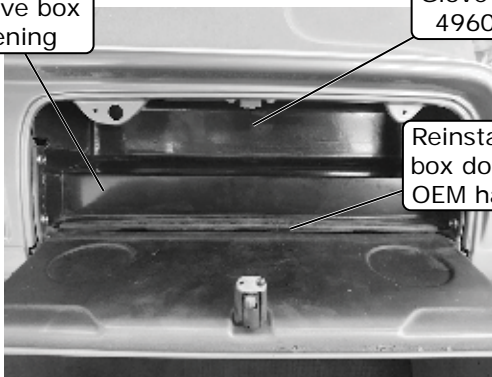

Photo 1

Install glove box into opening



Glove Box 496091

Reinstall glove box door using OEM hardware

Photo 2

Route passenger defrost duct behind glove box when installing



Glove Box 496091

Photo 3

## Final Steps: Completing the Install

1. Reinstall any previously removed items.
2. Fill radiator with at least a 50/50 mixture of approved antifreeze and distilled water. It is the owner's responsibility to keep the freeze protection at the proper level for the climate in which the vehicle is operated. Failure to follow antifreeze recommendations will cause heater core to corrode prematurely and possibly burst in A/C mode and/or freezing weather, voiding your warranty.
3. Double check all fittings, brackets and belts for tightness.
4. Vintage Air recommends that all A/C systems be serviced by a licensed automotive A/C technician.
5. Evacuate the system for a minimum of 45 minutes prior to charging, and perform a leak check prior to servicing.
6. Charge the system to the capacities stated on Page 4 of this instruction manual.
7. See Operation of Controls procedures on Page 26.



www.vintageair.com

## Duct Hose Routing

**NOTE:** For the system to function optimally, the duct hoses must be routed as directly as possible, taking care to avoid kinks, sharp bends and unnecessary length. Vintage Air supplies duct hoses in continuous lengths that will need to be cut to size depending on application. Before cutting, familiarize yourself with the installation instructions and verify the routing will work with your application. For custom hose routing, additional hose may be needed and can be purchased from Vintage Air.

1. Stretch the duct hose until there is no slack, measure, mark and cut hose to size (See Photo 1, below).

Stretch, measure, mark and cut hose to size



**Photo 1**

**Disclaimer:** Before cutting duct hose to length, verify the routing will work for your application.

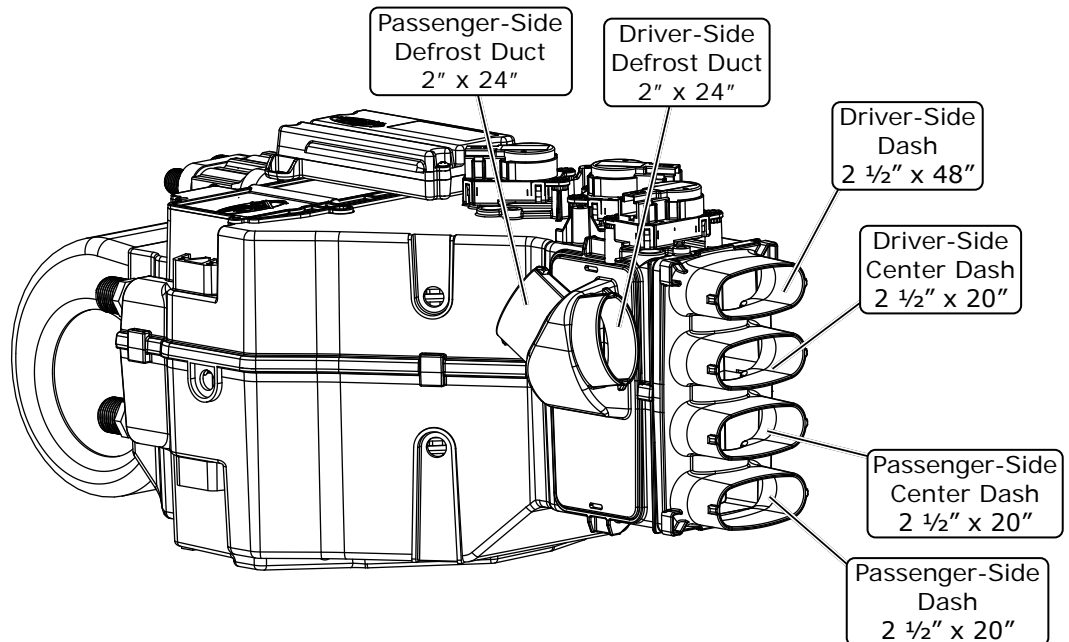

**NOTE:** ECU must be placed away from water and humidity, and also be accessible for servicing. If relocating, connectors must be positioned towards the bottom.



Position connectors towards bottom



www.vintageair.com

# Quality Crimp Guideline

Acceptable strip length  
(Some copper visible)

Crimped area is centered  
on each side of splice

Bad strip length  
(Too much copper visible)  
Visible copper should be  
just enough to ensure  
clearance between splice  
area and wire insulation

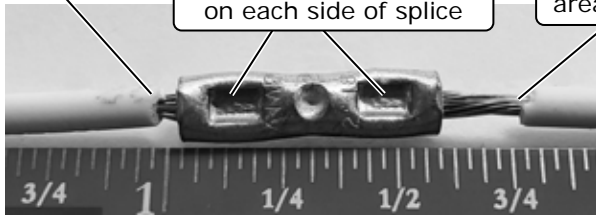

**Photo 1**

A good crimp requires  
seam of butt splice to be  
opposite of crimp die tooth

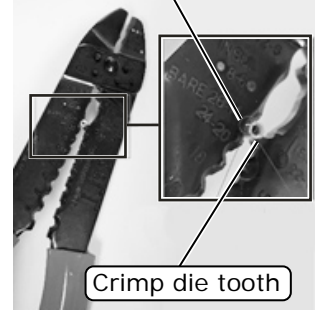

**Photo 2**

## Good Ring Terminal Crimp    Bad Ring Terminal Crimp

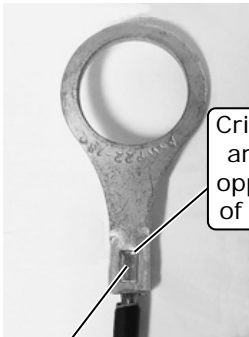

Crimped  
area is  
opposite  
of seam

**Photo 3**

Crimp  
area is  
centered  
on barrel

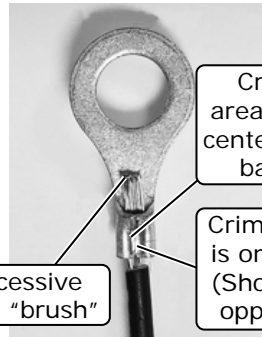

Crimp  
area is not  
centered on  
barrel

Excessive  
wire "brush"

Crimp area  
is on seam  
(Should be  
opposite)

**Photo 4**

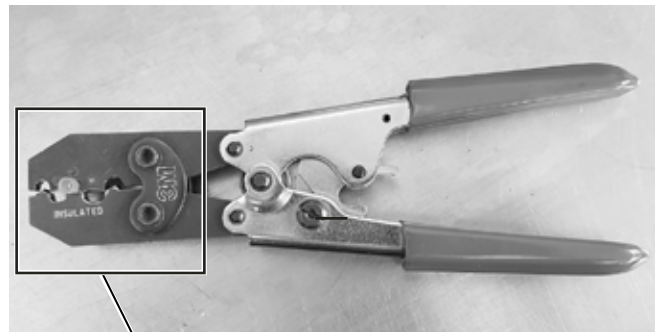

**Photo 5**

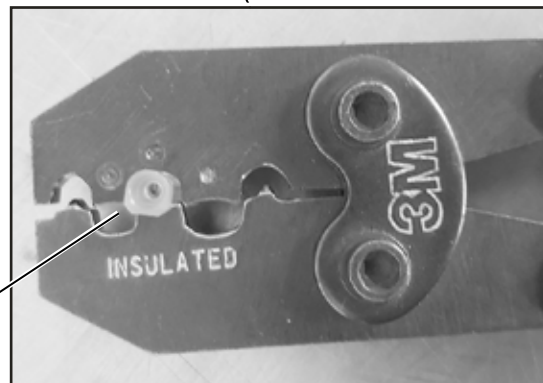

**Photo 5a**

Use a ratcheting crimp tool  
for insulated barrel terminals  
when crimping the provided  
female insulated terminal.  
Ensure terminal is inserted in  
appropriate position before  
crimping.



www.vintageair.com

# Gen 5 Wiring Diagram

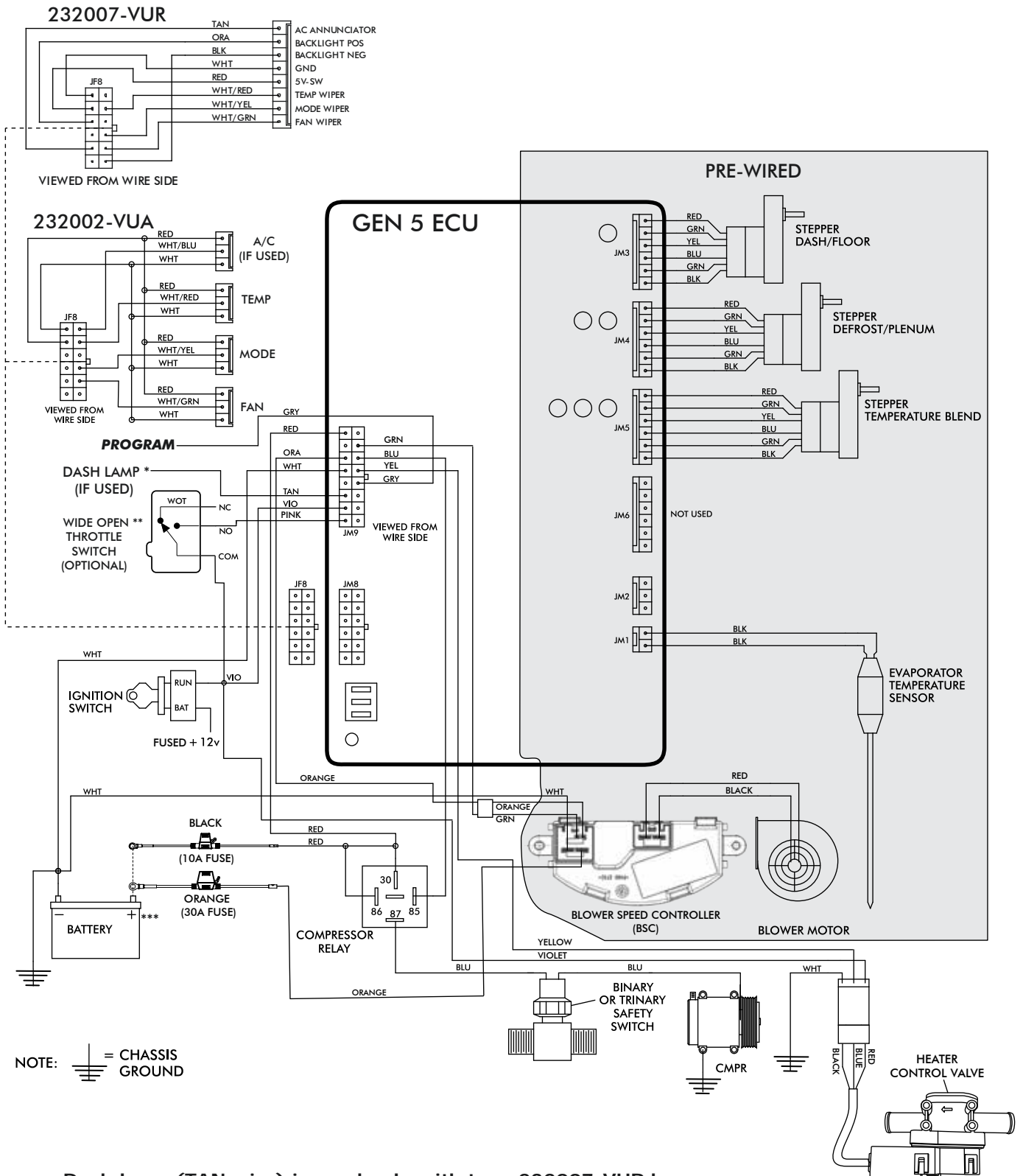

NOTE: = CHASSIS GROUND

- \* Dash lamp (TAN wire) is used only with type 232007-VUR harness.
- \*\* Wide open throttle switch contacts close only at full throttle, which disables A/C compressor.
- \*\*\* Install fuse assemblies at or as near to the battery as possible.



www.vintageair.com

# Gen 5 Wiring Instructions

WIRING HARNESS (231505) ↓

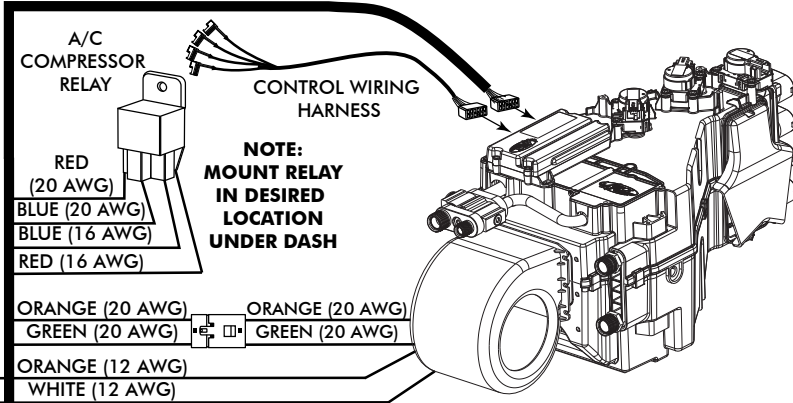

**NOTE:**  
MOUNT RELAY  
IN DESIRED  
LOCATION  
UNDER DASH

**Ignition Switch:**  
Using provided butt splice (PN 226004), connect the 20 AWG violet wire to a 5A fused and switched 12V source such as Key On.

**Wide Open Throttle Switch (Optional):**  
If a wide open throttle switch is required, connect the 20 AWG pink wire to a normally open switch that, when closed, connects a fused and switched 12V source to the pink wire. See Gen 5 wiring diagram for an example.

**Dash Light (Optional):**  
If using a Vintage Air control panel with back light, connect the 20 AWG tan wire to the vehicle's dash back light 0-12V using provided butt splice (PN 226004).

WIRING HARNESS (232020) →

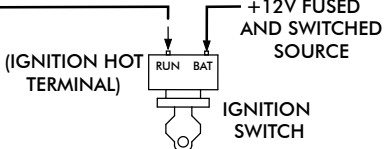
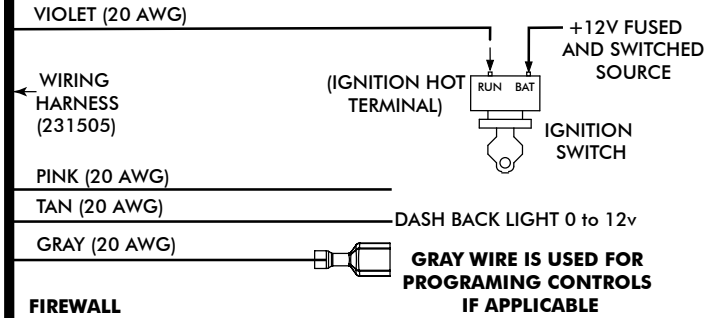

**Heater Control Valve:**  
Connect the Violet/Yellow/White twisted branch with 3 position connector into the heater control valve connector. Ensure that the mating latch is fully seated.

**Binary/Trinary & Compressor:**  
Binary Switch: Terminate provided insulated female terminal (PN 23172-VUW) to the blue 16 AWG wire. Connect as shown.  
Trinary Switch: Connect according to trinary switch wiring diagram.

WIRING HARNESS (232020) →

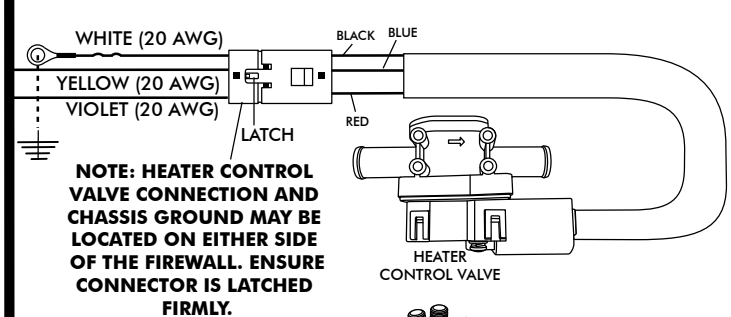

**NOTE: HEATER CONTROL VALVE CONNECTION AND CHASSIS GROUND MAY BE LOCATED ON EITHER SIDE OF THE FIREWALL. ENSURE CONNECTOR IS LATCHED FIRMLY.**

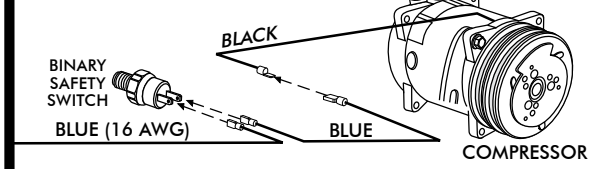

**Battery Connections:**  
ECU Ground: Terminate provided ring terminal (PN 226110) to 20 AWG white wire from the 231505 wire assembly and install at battery.  
ECU PWR: Terminate provided fuse assembly with black leads (PN 233012) to the 16 AWG red wire from the 231505 wire assembly. Install provided 10A Red Mini Fuse (PN 226118). Install at battery.  
Blower Speed Controller (BSC) Ground: Terminate provided ring terminal (PN 226111) to 12 AWG white wire from the 232020 wire assembly and install at battery.  
Blower Speed Controller (BSC) PWR: Terminate provided fuse assembly with orange leads (PN 233008) to the 12 AWG orange wire from the 232020 wire assembly. Install provided 30A Green ATO/ATC Fuse (PN 226125). Install at battery.

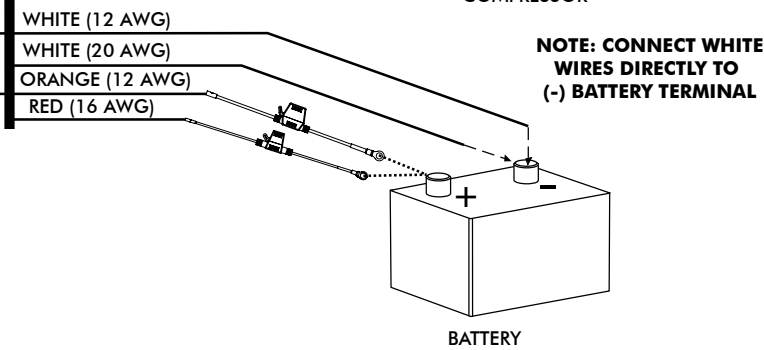



www.vintageair.com

## Operation of Controls

On Gen IV or Gen 5 systems with three lever/knob controls, the temperature control toggles between heat and A/C operations. To activate A/C, move the temperature lever/knob all the way to cold and then back it off to the desired vent temperature. For heat operation, move the temperature lever/knob all the way to hot and then adjust to the desired vent temperature. The blower will momentarily change speed, each time you toggle in and out of heat and A/C operations, to indicate the change. **NOTE: For proper control panel function, refer to control panel instructions for calibration procedure.**

### Blower Speed

This lever/knob controls blower speed, from OFF to HI.

### Mode Control

This lever/knob controls the mode positions, from DASH to FLOOR to DEFROST, with a blend in between.

### Temperature Control

This lever/knob controls the temperature, from HOT to COLD.

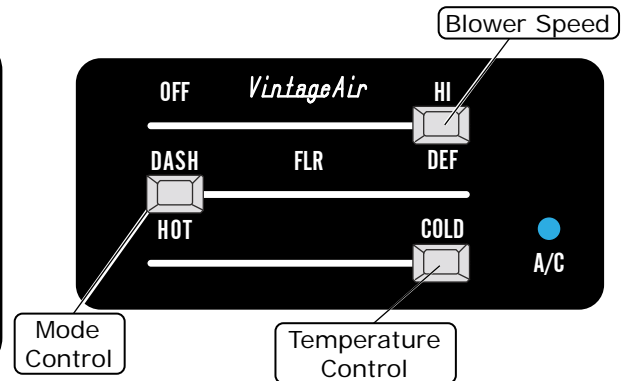

## A/C Operation

### Blower Speed

Adjust to desired speed.

### Mode Control

Adjust to desired mode position (DASH position recommended).

### Temperature Control

For A/C operation, adjust to coldest position to engage compressor (Adjust between HOT and COLD to reach desired temperature).



## Heat Operation

### Blower Speed

Adjust to desired speed.

### Mode Control

Adjust to desired mode position (FLOOR position recommended).

### Temperature Control

For maximum heating, adjust to hottest position (Adjust between HOT and COLD to reach desired temperature).

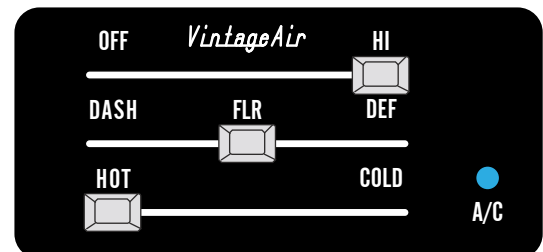

## Defrost/De-fog Operation

### Blower Speed

Adjust to desired speed.

### Temperature Control

Adjust to desired temperature.

### Mode Control

Adjust to DEFROST position for maximum defrost, or between FLOOR and DEFROST positions for a bi-level blend (Compressor is automatically engaged).

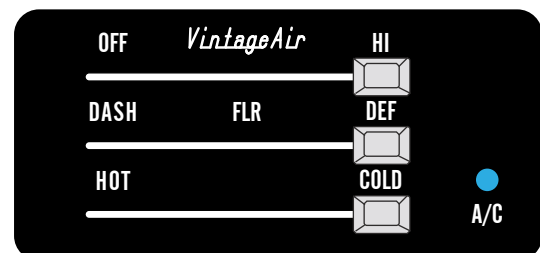



www.vintageair.com

# Troubleshooting Guide

This printed troubleshooting guide is our basic guide that covers common installation problems. To see our advanced diagnostics and troubleshooting guide, please refer to the following page for instructions on how to download the complete guide.

**WARNING: While troubleshooting the system, never probe connector terminals from the front mating side, only back probe.**

**WARNING: While troubleshooting the system, never use automotive check lights.**

Symptom	Condition	Checks	Actions	Notes
1. Blower stays on high speed with ignition on.	No other functions work.	Check for damaged pins or wires in the control panel wire assembly and mating header at ECU.	If found damaged, replace wire assembly or ECU.	If fuse continues to blow, there is a serious problem in the wiring. Check all wiring and ensure the wire is not damaged and shorting out along its route.
	All other functions work.	Check for a bad ECU GND. Check for damaged pins or wires in the control panel wire assembly and mating header at ECU. Check if Blower power fuse is blown. Check for a bad ECU GND.	If found damaged, replace wire assembly or ECU. Replace fuse. Repair connection.	
2. Compressor will not turn on (All other functions work).	System is not charged.	System must be charged for compressor to engage.	Charge system.	<b>Danger: Never bypass safety switch with engine running. Serious injury can result.</b>
	System is charged.	Check for faulty A/C potentiometer or associated wiring (not applicable to 3-pot controls). Check for disconnected or faulty thermistor.	Check continuity to ground on white control head wire. Check for 5V on red control head wire. Check 2-pin connector at ECU housing.	To check for proper pot function, check voltage at white/red wire. Voltage should be between 0V and 5V, and will vary with pot lever position. Disconnected or faulty thermistor will cause compressor to be disabled.
	Compressor will not turn off (All other functions work).	Check for faulty A/C potentiometer or associated wiring.	Repair or replace pot/control wiring.	Red wire at A/C pot should have approximately 5V with ignition on. White wire will have continuity to chassis ground. White/Red wire should vary between 0V and 5V when lever is moved up or down.
3. Compressor will not turn off (All other functions work).	System is charged.	Check for faulty A/C relay.	Replace relay.	



www.vintageair.com

# Troubleshooting Guide (Cont.)

Symptom	Condition	Checks	Actions	Notes
4. System will not turn on, or runs intermittently.	Works when engine is not running; shuts off when engine is started	Noise interference from either ignition or alternator.	Install capacitors on ignition coil and alternator. Ensure good ground at all points. Relocate coil and associated wiring away from ECU and ECU wiring. Check for burned or loose plug wires.	Ignition noise (radiated or conducted) will cause the system to shut down due to high voltage spikes. If this is suspected, check with a quality oscilloscope. Spikes greater than 16V will shut down the ECU. Install a radio capacitor at the positive post of the ignition coil (see radio capacitor installation bulletin). A faulty alternator or worn out battery can also result in this condition.
	Will not turn on under any conditions.	Verify connections on power lead, ignition lead, and both white ground wires. Verify battery voltage is greater than 10 volts and less than 16 while engine is running.	Check for power at ECU, and confirm ignition is being applied to ECU properly. Verify proper meter function by checking the condition of a known good battery.	
5. Loss of mode door function.	No mode change at all.	Check for damaged mode switch or potentiometer and associated wiring.		
	Blower turns on and off rapidly.	Battery voltage is at least 12V. Battery voltage is less than 12V.	Ensure all system grounds and power connections are clean and tight. Charge battery.	System shuts off blower at 10V. Poor connections or weak battery can cause shutdown at up to 11V.
7. Erratic functions of blower, mode, temp, etc.		Check for damaged switch or pot and associated wiring.	Repair or replace.	

## Advanced Diagnostics and Troubleshooting Guide

If after referencing the Troubleshooting Guide, the issue is not resolved, move to The Advanced Diagnostics and Troubleshooting Guide that covers the following:

- ECU Diagnostics Codes
- 1. ECU Blink Sequence
- 2. Firmware Version Number
- 3. ECU Model Number
- 4. ECU Start-Up Blink Sequence
- 5. Diagnostic Codes
- Complete Advanced Troubleshooting Guidelines

Access the latest version of the Advanced Diagnostics and Troubleshooting Guide by scanning the following QR code on your mobile device:



You can also access the guide by typing the following address into your web browser:

[https://www.vintageair.com/instructions\\_pdf/905000.pdf](https://www.vintageair.com/instructions_pdf/905000.pdf)





www.vintageair.com

## Packing List: Evaporator Kit (751583)

No.	Qty.	Part No.	Description
1.	1	765225	Gen 5 Magnum Max Module with 444 ECU
2.	1	791583	Accessory Kit

Checked By: \_\_\_\_\_  
Packed By: \_\_\_\_\_  
Date: \_\_\_\_\_

1



Gen 5 Magnum Max  
Module with 444 ECU  
765225

2

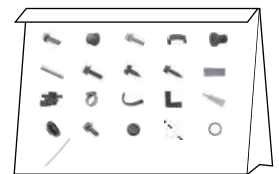
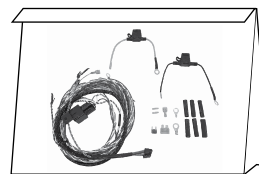
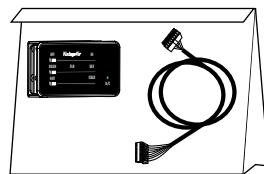
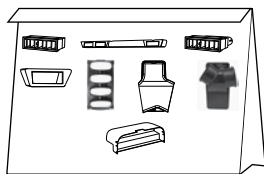
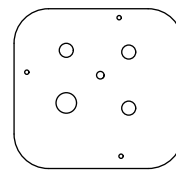
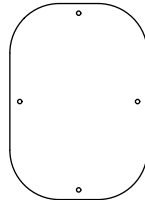
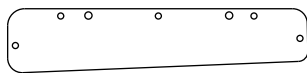
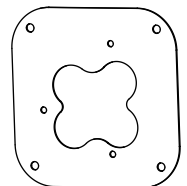
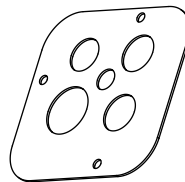
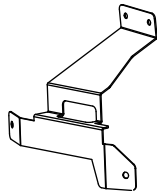
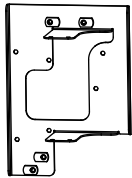

Accessory Kit  
791583

**NOTE: Images may not depict actual parts and quantities.  
Refer to packing list for actual parts and quantities.**