

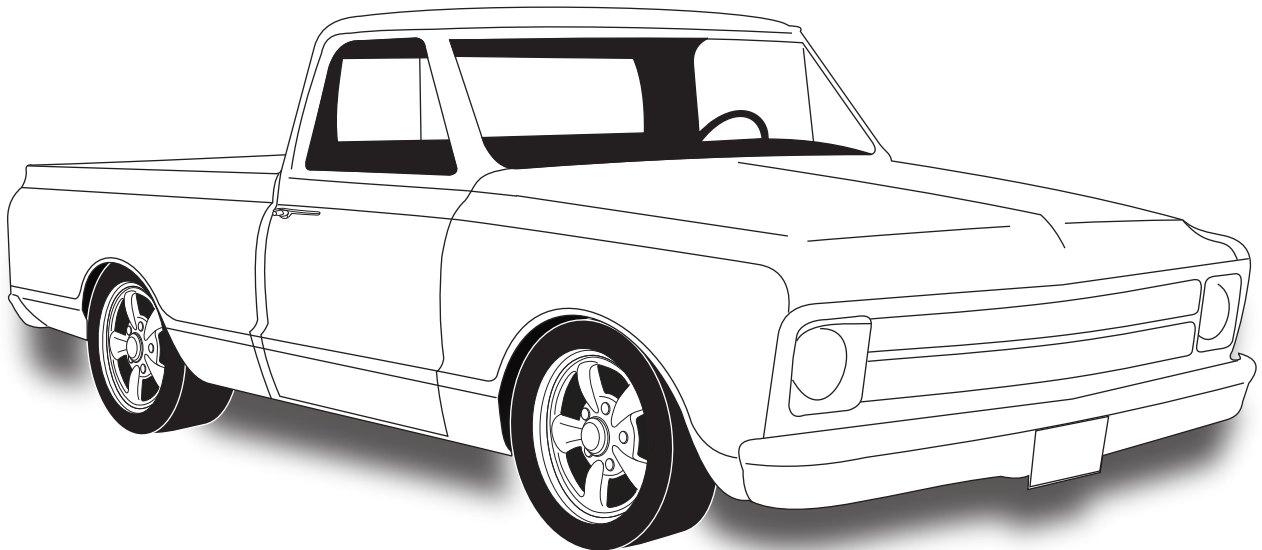

1967-72 Chevrolet Pickup

with Factory Air
Gen 5 Evaporator Kit
(755606)



18865 Goll St. San Antonio, TX 78266
Phone: 800-862-6658
Sales: sales@vintageair.com
Tech Support: tech@vintageair.com
www.vintageair.com



www.vintageair.com

Table of Contents

Cover.....	1
Table of Contents.....	2
Packing List/Parts Disclaimer.....	3
Information Page.....	4
Wiring Notice.....	5
Engine Compartment Disassembly, Condenser Assembly and Installation, Compressor and Brackets.....	6
Passenger Compartment Disassembly, Firewall Modification.....	7
Lubricating O-rings, Evaporator Preparation.....	8
Evaporator Preparation (Cont.).....	9
Evaporator Preparation (Final).....	10
Firewall Cover Preparation, Fresh Air Cap, Firewall Cover & Insulation Installation.....	11
Fresh Air Cap, Firewall Cover & Insulation Installation (Cont.).....	12
Defrost Duct and Louver Installation.....	13
Wiring.....	14
Evaporator Installation.....	15
Evaporator Installation (Cont.).....	16
Drain Hose Installation, A/C Hose Installation.....	17
Heater Hose & Heater Control Valve Installation.....	18
A/C and Heater Hose Routing.....	19
Passenger Compartment Wiring, Engine Compartment Wiring.....	20
Engine Compartment Wiring (Cont.).....	21
ECU, Control Panel & Duct Hose Routing.....	22
Final Steps: Installation Check.....	23
Final Steps: Completing the Install.....	24
Quality Crimp Guideline.....	25
Gen 5 Wiring Diagram.....	26
Gen 5 Wiring Connection Instruction.....	27
Operation of Controls.....	28
Troubleshooting Guide.....	29
Troubleshooting Guide (Cont.), Advanced Diagnostics and Troubleshooting Guide.....	30
Packing List.....	31



www.vintageair.com

Packing List: Evaporator Kit (755606)

No.	Qty.	Part No.	Description
1.	1	765200	Gen 5 Super Magnum Module
2.	1	795606	Accessory Kit

**** Before beginning installation, open all packages and check contents of shipment. Please report any shortages directly to Vintage Air within 15 days. After 15 days, Vintage Air will not be responsible for missing or damaged items.**

1

Gen 5 Super Magnum
Module
765200



2

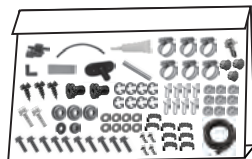
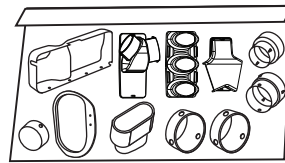
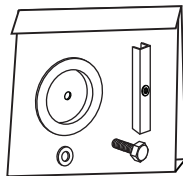
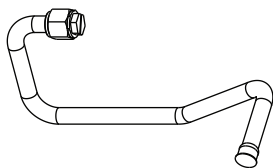
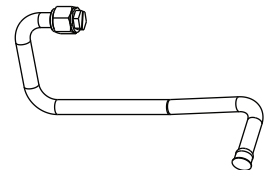
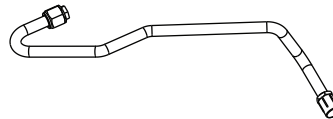
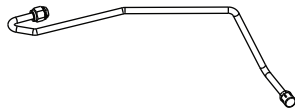
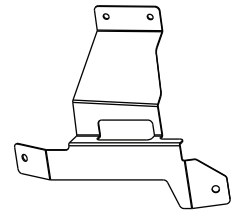
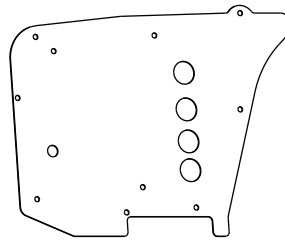

Accessory Kit
795606

NOTE: Images may not depict actual parts and quantities. Refer to packing list for actual parts and quantities.



www.vintageair.com

Important Notice—Please Read

For Maximum System Performance, Vintage Air Recommends the Following:

NOTE: Vintage Air systems are designed to operate with R134a refrigerant only. Use of any other refrigerant could damage your A/C system and/or vehicle, and possibly cause a fire, in addition to potentially voiding the warranties of the A/C system and its components.

Refrigerant Capacities:

Vintage Air System: 1.8 lbs. (28.8 oz.) or 816 grams of **R134a**, charged by weight with a quality charging station or scale. **NOTE: Use of the proper type and amount of refrigerant is critical to system operation and performance.**

Other Systems: Consult manufacturer's guidelines.

Lubricant Capacities:

New Vintage Air-Supplied Sanden Compressor: No additional oil needed (Compressor is shipped with proper oil charge).

All Other Compressors: Consult manufacturer (Some compressors are shipped dry and will need oil added).

Safety Switches

Your Vintage Air system is equipped with a binary pressure safety switch. A binary switch disengages the compressor clutch in cases of extreme low pressure conditions (refrigerant loss) or excessively high head pressure (406 PSI) to prevent compressor damage or hose rupture. A trinary switch combines Hi/Lo pressure protection with an electric fan operation signal at 254 PSI, and should be substituted for use with electric fans. Compressor safety switches are extremely important since an A/C system relies on refrigerant to circulate lubricant.

Service Info:

Protect Your Investment: Prior to assembly, it is critical that the compressor, evaporator, A/C hoses and fittings, hardlines, condenser and receiver/drier remain capped. Removing caps prior to assembly will allow moisture, insects and debris into the components, possibly leading to reduced performance and/or premature failure of your A/C system. This is especially important with the receiver/drier.

Additionally, when caps are removed for assembly, **BE CAREFUL!** Some components are shipped under pressure with dry nitrogen.

Evacuate the System for 35-45 Minutes: Ensure that system components (Drier, compressor, evaporator and condenser) are at a temperature of at least 85°F. On a cool day, the components can be heated with a heat gun **or** by running the engine with the heater on before evacuating. Leak check and charge to specifications.

Bolts Passing Through Cowl and/or Firewall:

To ensure a watertight seal between the passenger compartment and the vehicle exterior, for all bolts passing through the cowl and/or firewall, Vintage Air recommends coating the threads with silicone prior to installation.

Heater Hose (not included with this kit):

Heater hose may be purchased from Vintage Air (Part#31800-VUD) or your local parts retailer. Routing and required length will vary based on installer preference.



www.vintageair.com

Important Wiring Notice—Please Read

Some vehicles may have had some or all of their radio interference capacitors removed. There should be a capacitor found at each of the following locations:

- 1. On the positive terminal of the ignition coil.**
- 2. If there is a generator, on the armature terminal of the generator.**
- 3. If there is a generator, on the battery terminal of the voltage regulator.**

Most alternators have a capacitor installed internally to eliminate what is called “whining” as the engine is revved. If whining is heard in the radio, or just to be extra cautious, a radio interference capacitor can be added to the battery terminal of the alternator.

It is also important that the battery lead is in good shape and that the ground leads are not compromised. There should be a heavy ground from the battery to the engine block, and additional grounds to the body and chassis.

If these precautions are not observed, it is possible for voltage spikes to be present on the battery leads. These spikes come from ignition systems and charging systems, and from switching some of the vehicle’s other systems on and off. Modern computer-operated equipment can be sensitive to voltage spikes on the power leads, which can cause unexpected resets, strange behavior and/or permanent damage.

Vintage Air strives to harden our products against these types of electrical noise, but there is a point where a vehicle’s electrical system can be degraded so much that nothing can help.

Radio interference capacitors should be available at most auto and truck parts suppliers. They typically are cylindrical in shape, a little over an inch long and a little over a half-inch in diameter, and they have a single lead coming from one end of the cylinder with a terminal on the end of the wire, as well as a mounting clip which is screwed into a good ground on the vehicle. The specific value of the capacitance is not too significant in comparison to ignition capacitors that are matched with the coil to reduce pitting of the points.

- Care must be taken, when installing the compressor lead, not to short it to ground. The compressor lead must not be connected to a condenser fan or to any other auxiliary device. Shorting to ground or connecting to a condenser fan or any other auxiliary device may damage wiring or the compressor relay, and/or cause a malfunction.
- When installing ground leads on Gen 5 systems, the blower control ground and ECU ground must be connected directly to the negative battery post.
- For proper system operation, the heater control valve must be connected to the ECU.



www.vintageair.com

Engine Compartment Disassembly

NOTE: Before starting the installation, check the function of the vehicle (horn, lights, etc.) for proper operation, and study the instructions, illustrations, & diagrams.

Perform the Following:

1. Disconnect the battery.
2. Drain and remove the radiator (retain).
3. Evacuate the A/C system (if necessary).
4. Remove the OEM condenser and drier (discard) (See Figure 1, below).
5. Remove the A/C lines from the compressor to the evaporator (discard).
6. Remove the compressor and bracket (discard).
7. Remove the evaporator blower assembly (discard). **NOTE: To remove the evaporator blower assembly (under hood) and the air distribution system (under dash), the factory manual recommends that the right inner fender be removed for accessibility.**
8. Remove the OEM heater hoses, A/C hoses and hardlines, vacuum actuator (air inlet valve) (discard) (See Figure 1 and 1a, below).
9. Install the cowl vent rod cap and secure it using (2) #14 x 3/4" sheet metal screws as shown in Figure 1a, below.

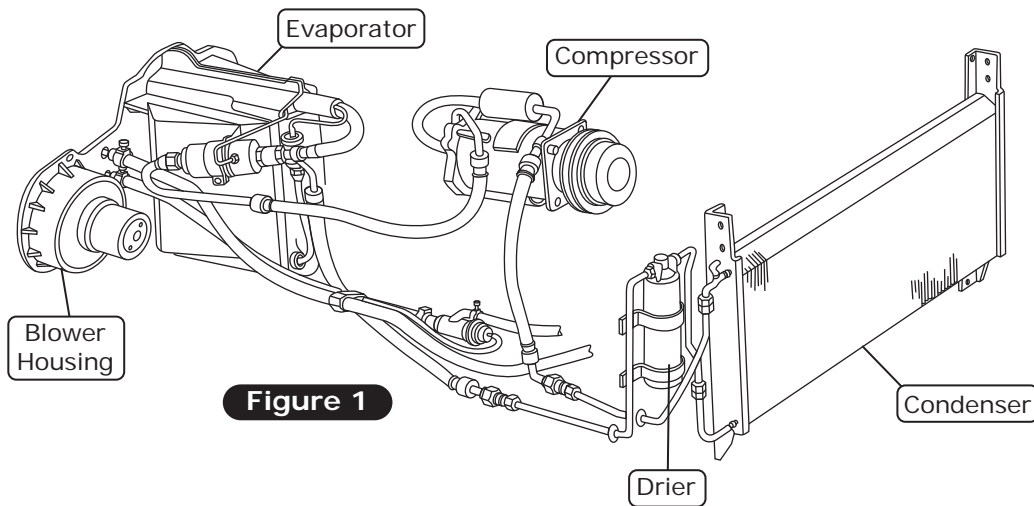

Figure 1

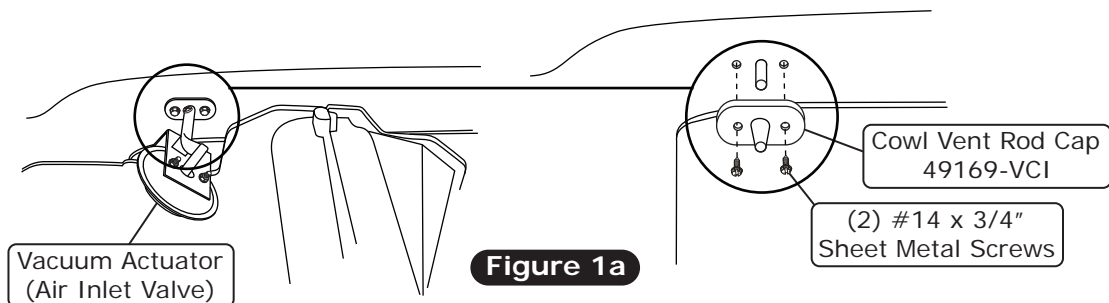

Figure 1a

Condenser Assembly and Installation

1. Refer to separate instructions included with the condenser kit to install the condenser.
2. Binary switch installation (Refer to condenser instructions).

Compressor and Brackets

1. Refer to separate instructions included with the bracket kit to install the compressor bracket.



www.vintageair.com

Passenger Compartment Disassembly

Perform the Following:

1. Remove the glove box door (retain) and glove box (discard).
2. Disconnect all wires and cables from OEM control panel and radio.
3. Remove all hoses and ducting from the OEM louvers and defrost ducts (See Figure 1, below).
4. Remove the OEM A/C and heater assembly.
5. Remove the fresh air door assembly as shown in Figure 1a, below.
6. Apply a 1/4" bead of silicone on the back side of the kick panel cap, then install it using the OEM screws (See Figure 1b, below).

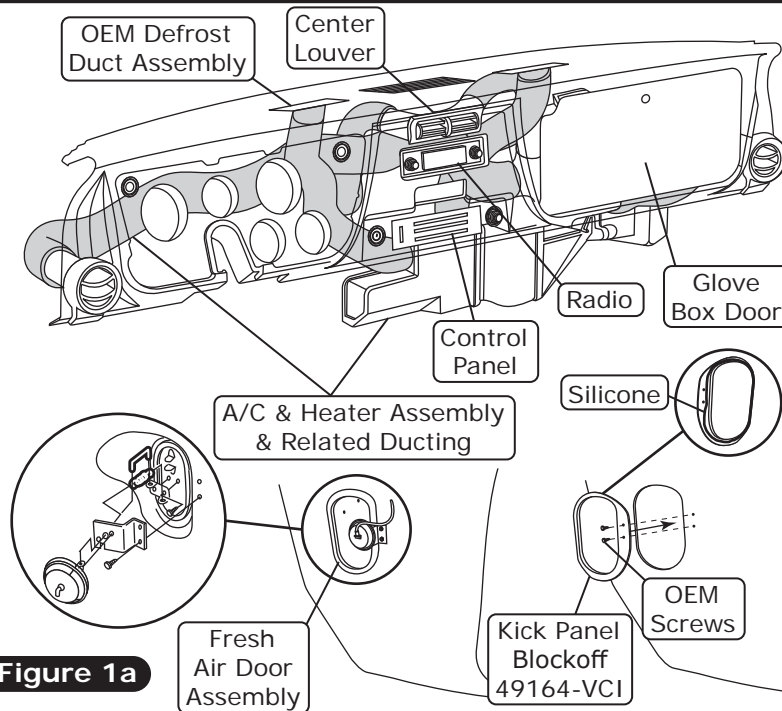

Figure 1

Figure 1a

Figure 1b

Firewall Modification

NOTE: The firewall requires modification for the drain hose to be installed. Place the firewall cover onto the firewall, lining up the OEM mounting holes. Mark all the other mounting holes, then remove the firewall cover and drill using a 5/16" drill bit.

1. Using the bead roll on the floor pan for reference, measure 2" to the right and 1" down. Mark and drill a 5/8" hole for the drain hose (See Photos 1 and 2, below). **NOTE: To ensure a tight fit for the drain hose, do not enlarge the drain hose more than 5/8".**

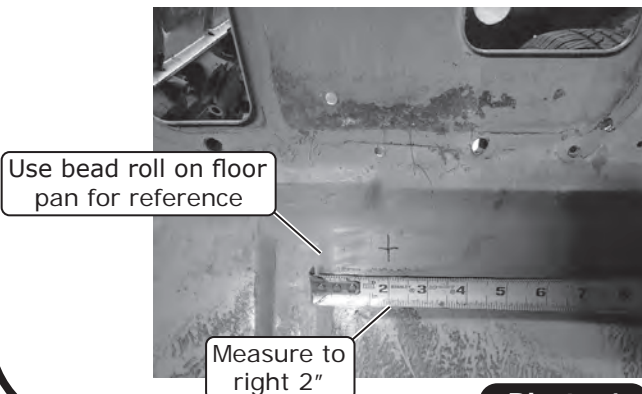

Photo 1

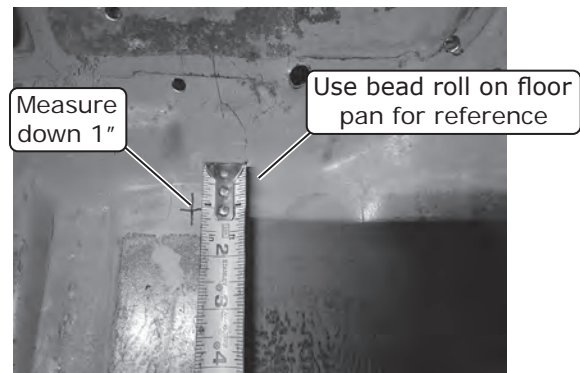

Photo 2



www.vintageair.com

Lubricating O-rings

For a proper seal of fittings: Install supplied O-rings as shown and lubricate with refrigerant oil.

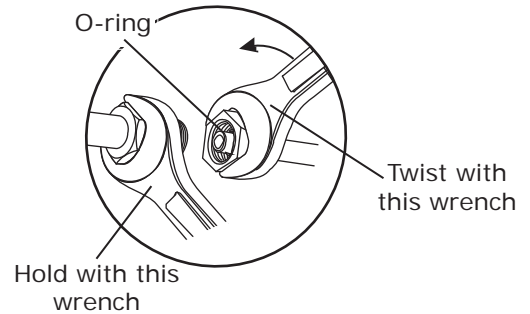
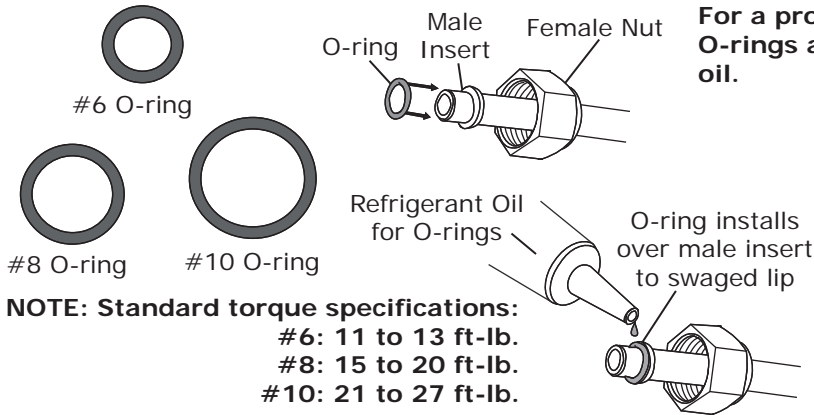

Evaporator Preparation

NOTE: Before fully tightening the hardlines, ensure they are aligned with the opening on the firewall cover as shown. Use a backup wrench when tightening fittings.

Perform the following on a workbench:

1. Install (3) 1/2" plastic plugs into the back of the evaporator module (See Photo 1, below).
2. Place the evaporator rear bracket onto the evaporator and secure it using (4) #10 x 5/8" screws (See Photos 2, 3 and 4, below).

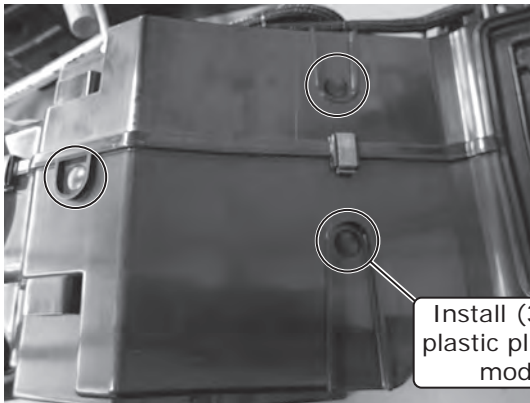

Install (3) 1/2" plastic plugs into module

Photo 1

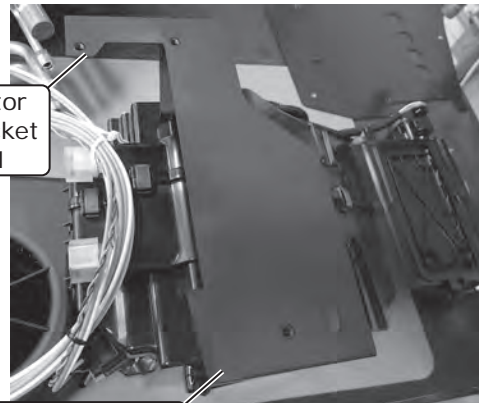

Evaporator Rear Bracket 644191

Place evaporator rear bracket onto evaporator

Photo 2



Secure bracket to evaporator using (2) #10 x 5/8" screws

Bottom View of Module

Photo 3

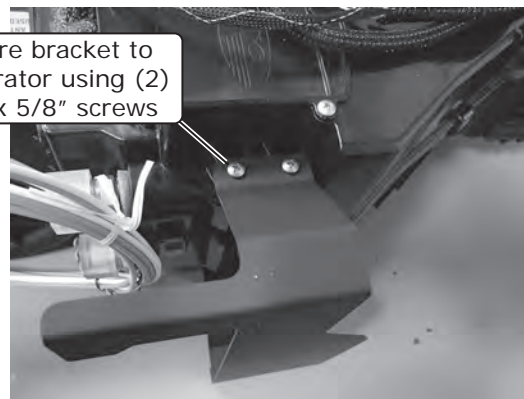

Secure bracket to evaporator using (2) #10 x 5/8" screws

Top View of Module

Photo 4



www.vintageair.com

Evaporator Preparation (Cont.)

3. Apply press tape onto the #10 suction hardline, stopping 1" from the end (See Photos 5 and 6, below).
NOTE: Wrap press tape around hardline lengthwise as shown in Photo 7, below.
4. With a properly lubricated #6 O-ring (See Lubricating O-rings, Page 8), loosely install the #6 liquid hardline onto the #6 fitting on the block valve adapter (See Photo 8, below).
5. With a properly lubricated #10 O-ring (See Lubricating O-rings, Page 8), loosely install the #10 suction hardline onto the #10 fitting on the block valve adapter (See Photo 9, below).
6. With a properly lubricated #10 O-ring (See Lubricating O-rings, Page 8), loosely install the heater intake hardline onto the lower heater fitting on the evaporator (See Photo 10, below).
7. With a properly lubricated #10 O-ring (See Lubricating O-rings, Page 8), loosely install the heater water pump hardline onto the upper heater fitting on the evaporator (See Photo 11, below).

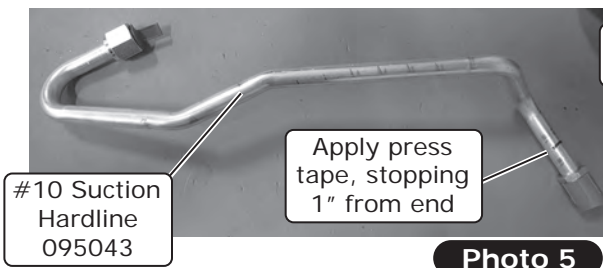

Photo 5

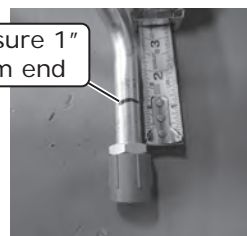

Photo 6

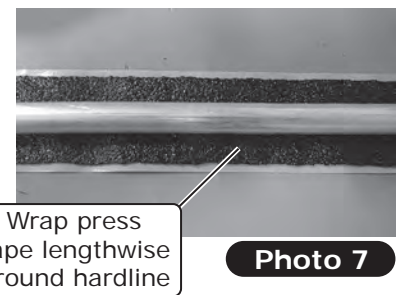

Photo 7

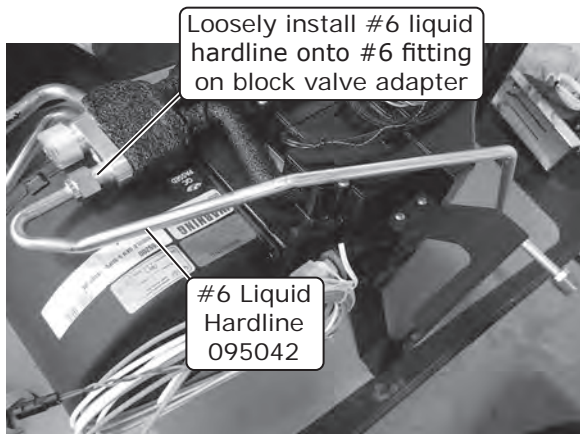

Photo 8

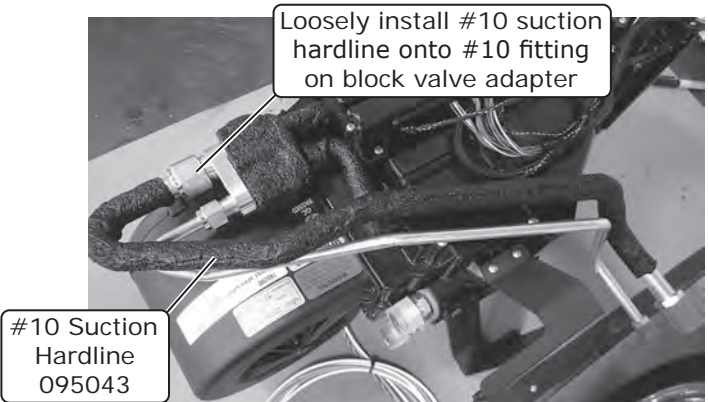

Photo 9

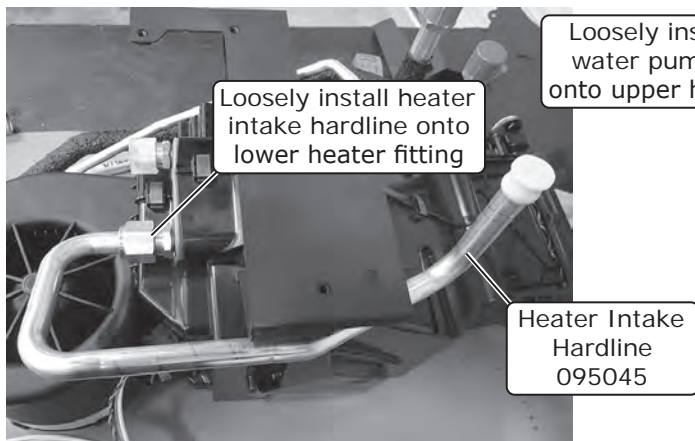

Photo 10

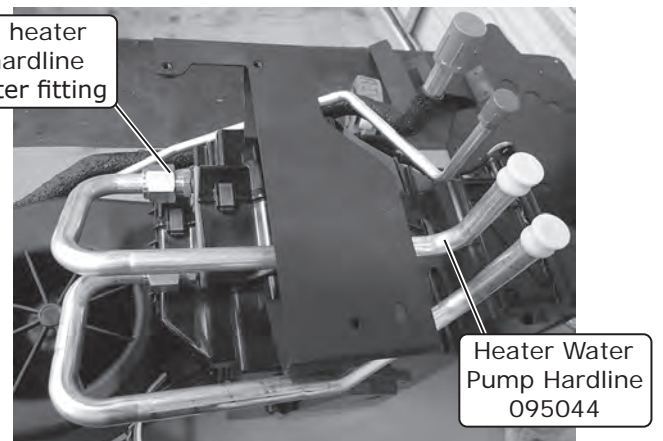

Photo 11



www.vintageair.com

Evaporator Preparation (Final)

8. Install a 1/4-20 x 1 1/2" full-threaded stud into the evaporator rear bracket weldnut (See Photo 12, below).
9. Place the firewall cover over the full-threaded stud, then line up the lower mounting hole and center the hardlines within the openings (See Photo 13, below).
10. Remove the firewall cover, then tighten the hardlines.
11. Wrap all exposed metal at the block fitting adapter and the #10 suction hardline with press tape (See Photo 14, below).
12. Using (4) spring clips, install the dash plenum onto the evaporator as shown in Photo 15, below.
13. Using (2) spring clips, install the floor plenum onto the back of the evaporator (See Photo 16, below).
14. Using (2) spring clips, install the defrost plenum onto the front of the evaporator (See Photo 17, below).

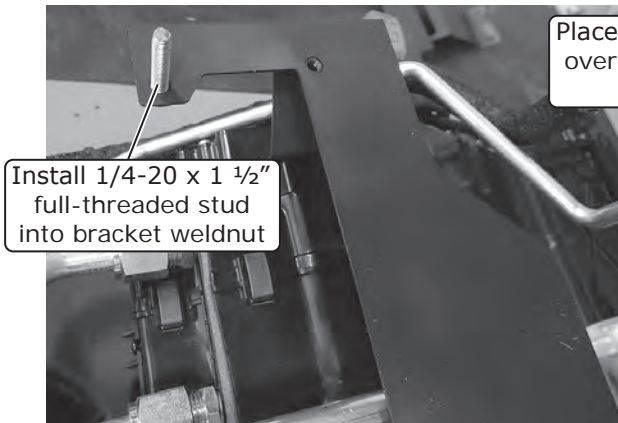

Photo 12

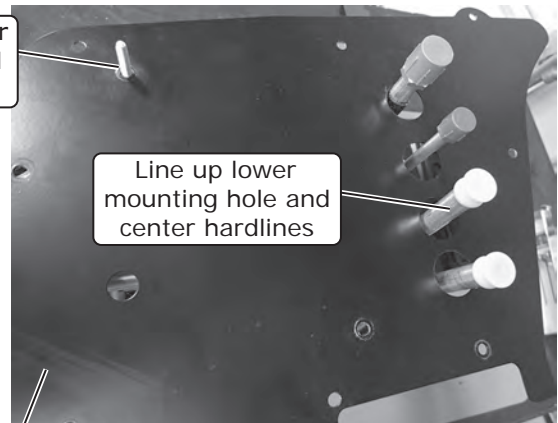
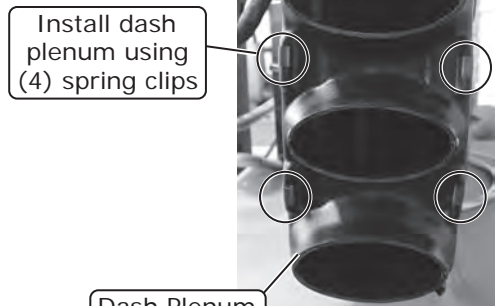

Photo 13

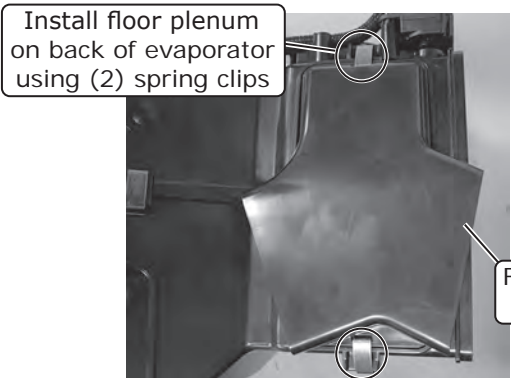

Photo 14



Dash Plenum 629909

Photo 15



Floor Plenum 625338

Photo 16

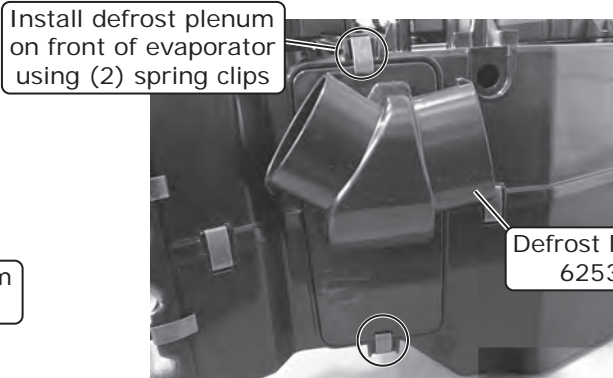

Defrost Plenum 625331

Photo 17



www.vintageair.com

Firewall Cover Preparation

1. Install (9) 1/4-20 x 3/4" serrated flange black zinc bolts and (9) 3/16" push-on rings onto the firewall cover as shown in Photo 1, below.

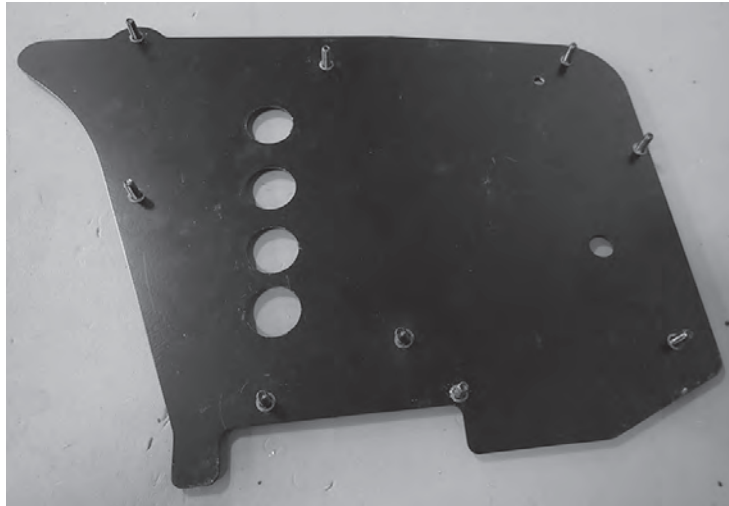

Photo 1

Fresh Air Cap, Firewall Cover and Insulation Installation

NOTE: For proper system operations, Vintage Air recommends using heat-blocking insulation in the area around the evaporator module (firewall, kick panel, inner cowl, firewall covers). Due to tight clearance for the evaporator module between the firewall and dash, Vintage Air recommends an insulation thickness of no more than 1/4". To ensure a watertight seal between the passenger compartment and the vehicle exterior, for all bolts passing through the firewall, Vintage Air recommends coating the threads with silicone prior to installation.

1. Apply a 1/4" bead of silicone around the back side of the fresh air cap as shown in Figure 1, below.
2. Attach the fresh air cap to the firewall using a 1/4-20 x 1" hex bolt and 1/4" washer (See Figure 1, below).
3. Install grommets onto the firewall cover as shown in Photo 1, below.

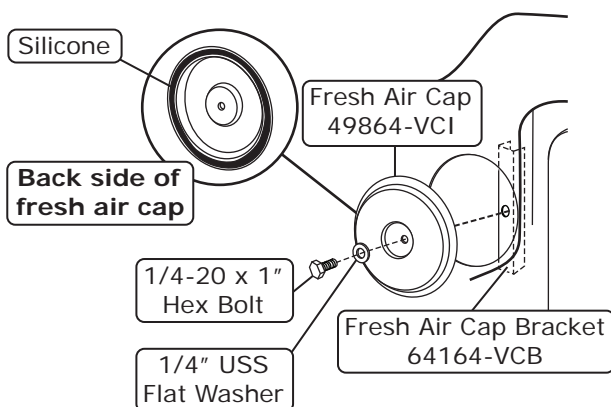

Figure 1



Photo 1



www.vintageair.com

Fresh Air Cap, Firewall Cover and Insulation Installation (Cont.)

4. Apply a 1/4" bead of silicone onto the mating surface of the firewall (See Photo 2, below).
5. Install the firewall cover onto the firewall using (9) 1/4" USS flat washers and (9) 1/4-20 nuts with star washers (See Photos 3 and 4, below).
6. Install the heat-blocking insulation at this time.

Apply 1/4" bead of silicone onto mating surface of firewall



Photo 2

Install firewall cover onto firewall



Photo 3



Secure firewall cover using (9) 1/4" USS flat washers and (9) 1/4-20 nuts with star washers

Photo 4

Apply heat-blocking insulation at this time

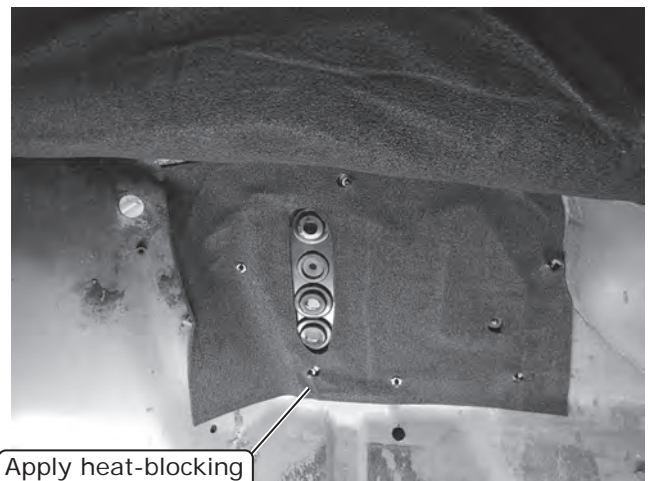

Photo 5



www.vintageair.com

Defrost Duct and Louver Installation

1. Install S-clips onto the defrost duct hose adapters, and attach them to the OEM defrost ducts as shown in Figure 1, below.
2. Install the OEM center vent hose adapter and cap onto the center louver plenum as shown in Figure 1, below.
3. Install S-clips onto the side louver hose adapters and attach them to the OEM driver-/passenger-side louver hose adapters as shown in Figure 1a, below. **NOTE: Bend edges of the duct, then insert it into the adapter. Do not screw adapter onto the duct hose, as it will damage the hose.**

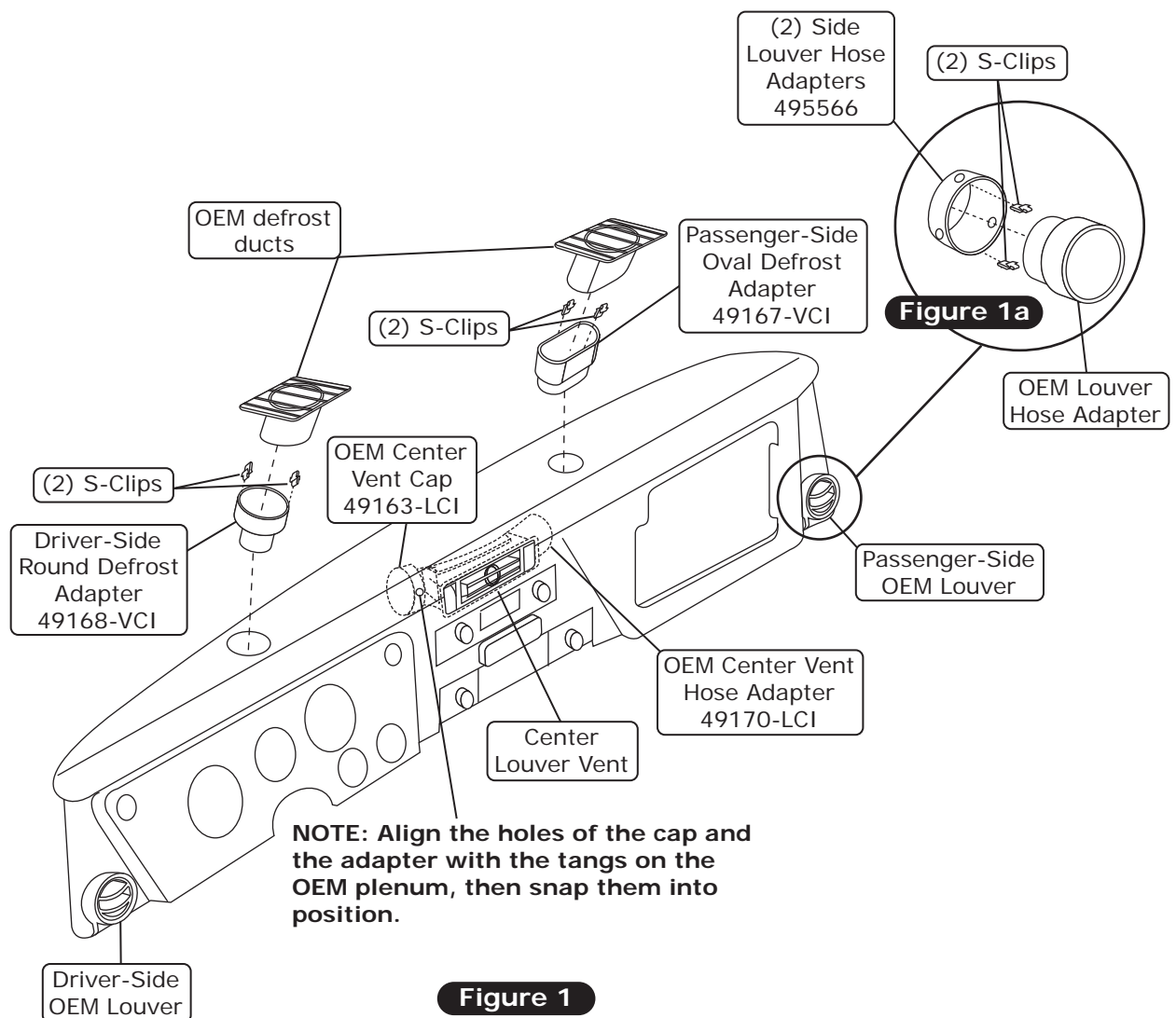



www.vintageair.com

Wiring

1. Route the heater control valve connector and wiring through the wiring grommet on the firewall cover (See Photos 1 and 2, below).
2. Leave approximately 20" of wiring between the firewall cover and the relay.
3. Select a suitable location for the main relay and secure it using a #10 x 1/2" sheet metal screw. Select a suitable ground location for the white ground wire eyelet from the heater control valve harness and secure it using a #12 x 1/2" self-tapping screw (See Photo 3, below).
4. Route the red, white and blue wires from the harness through the wiring grommet (See Photo 4, below).

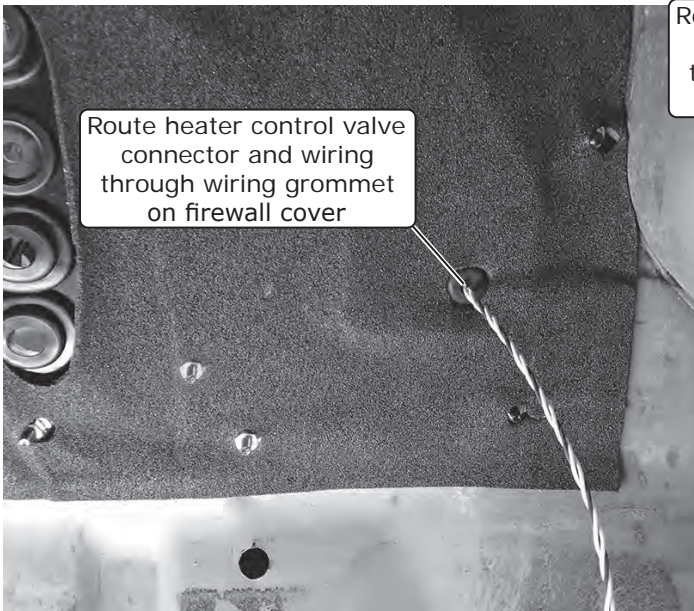

Passenger Compartment View

Photo 1

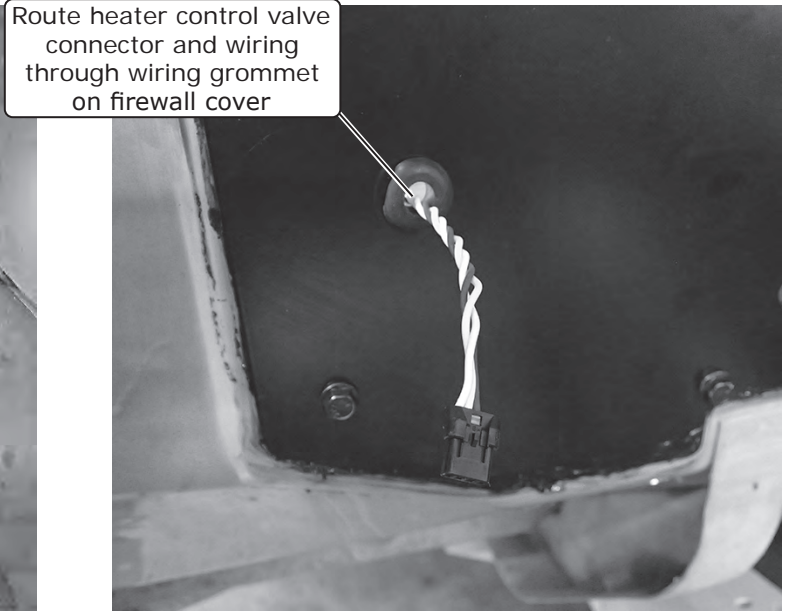

Engine Compartment View

Photo 2

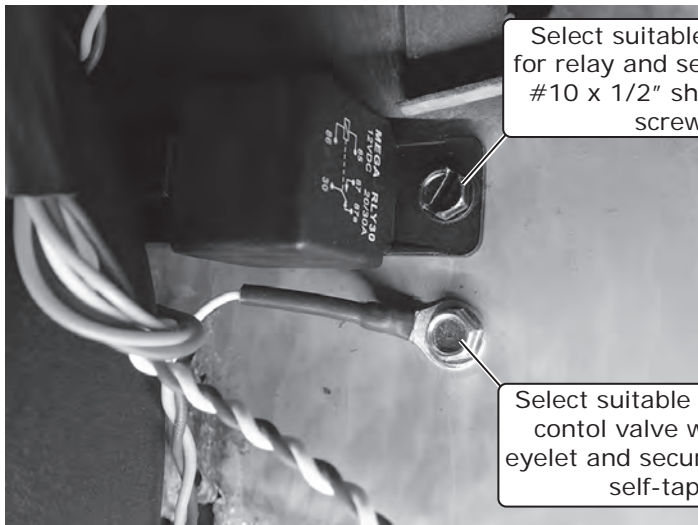

Photo 3

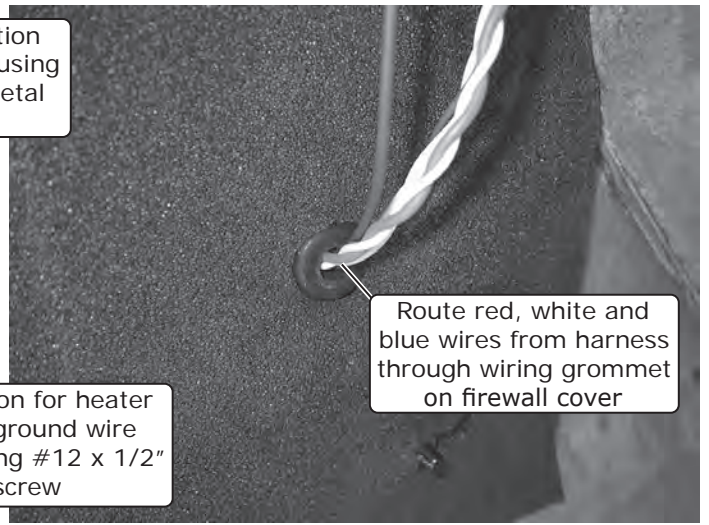

Photo 4



www.vintageair.com

Evaporator Installation

NOTE: To ensure a watertight seal between the passenger compartment and the vehicle exterior, for all bolts passing through the firewall, Vintage Air recommends coating the threads with silicone prior to installation.

1. Place the evaporator module on the passenger side floorboard.
2. Route the orange and white wires through the wiring grommet into the engine compartment (See Photo 1, below).
3. Lift the evaporator module into position using the 1/4-20 x 1" full-threaded stud and 1/4-20 x 3/4" firewall cover bolt to locate the correct mounting location (See Photo 2, below). **NOTE: The ECU may be loosened to ease the installation.**
4. Install (2) 1/4-20 well nuts into the evaporator module front mounting locations (See Photo 3, below).
5. Install the evaporator front bracket onto the evaporator module using (2) 1/4-20 x 1" serrated flange hex bolts (See Photo 4, below).

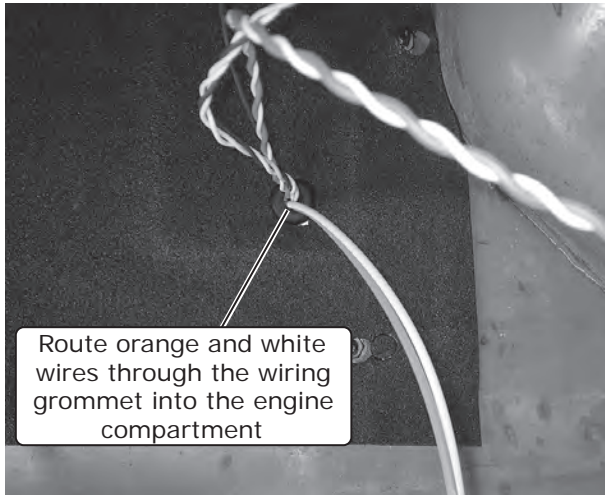

Passenger Compartment View

Photo 1

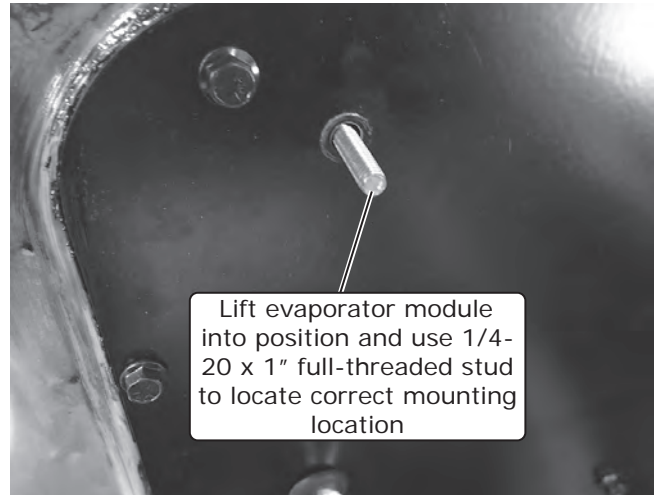

Engine Compartment View

Photo 2

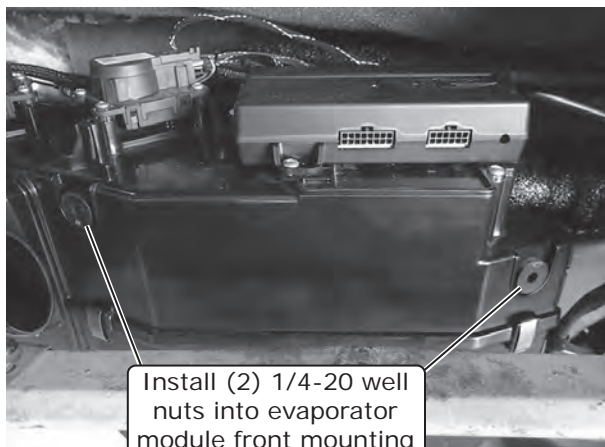

Install (2) 1/4-20 well nuts into evaporator module front mounting locations

Photo 3

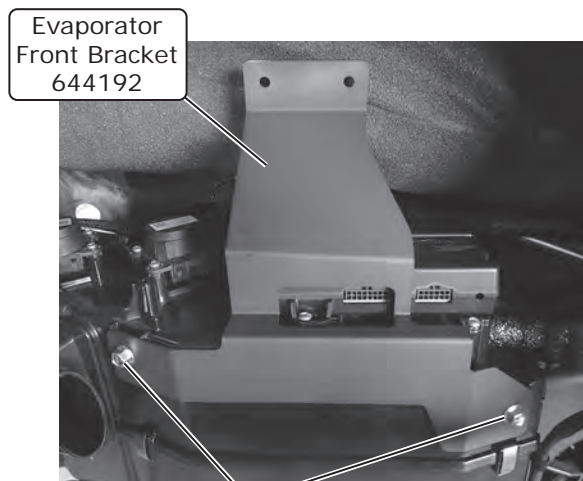

Evaporator Front Bracket 644192

(2) 1/4-20 x 1" Serrated Flange Hex Bolts

Photo 4



www.vintageair.com

Evaporator Installation (Cont.)

6. Level the module left-right and fore-aft (See Photos 5 and 6, below). Using the evaporator front bracket as a template, mark and drill (2) pilot holes into the cowl. Coat (2) #10 x 1/2" sheet metal screws with silicone, then secure the bracket into the cowl (See Photo 7, below).
7. From the engine compartment, replace the full-threaded stud with a 1/4-20 x 3/4" serrated flange black zinc hex bolt (See Photos 8 and 9, below).
8. From the passenger compartment, install a 1/4-20 nut with star washer onto the 1/4-20 x 3/4" serrated flange black zinc hex bolt installed on the previous step (See Photo 10, below).

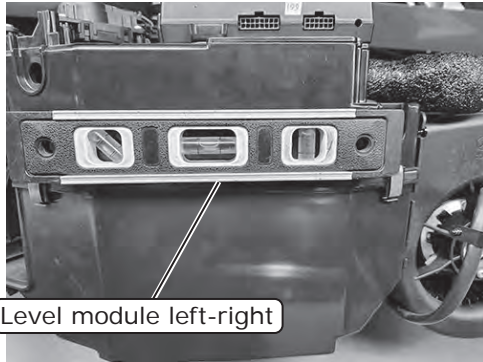

Level module left-right

Photo 5



Level module fore-aft

Photo 6

Use evaporator front bracket as template, then mark and drill (2) pilot holes into cowl

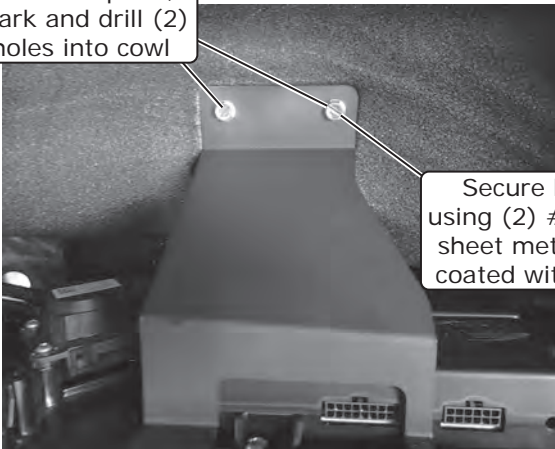

Secure bracket using (2) #10 x 1/2" sheet metal screws coated with silicone

Photo 7

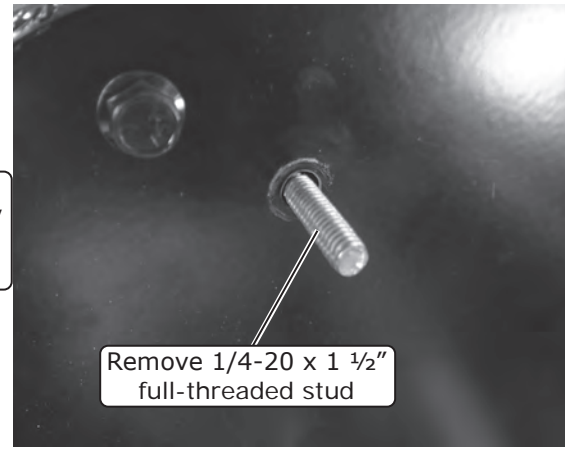

Remove 1/4-20 x 1 1/2" full-threaded stud

Engine Compartment View

Photo 8

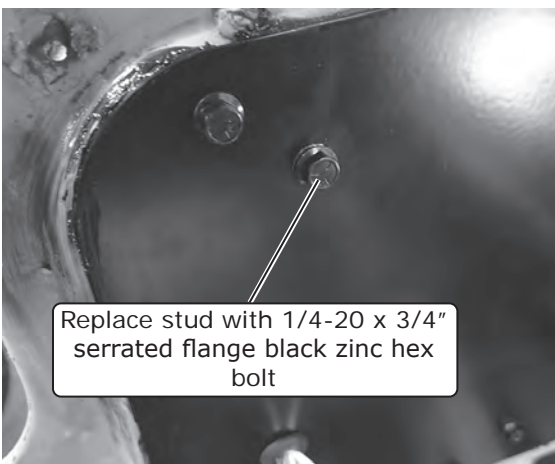

Replace stud with 1/4-20 x 3/4" serrated flange black zinc hex bolt

Engine Compartment View

Photo 9

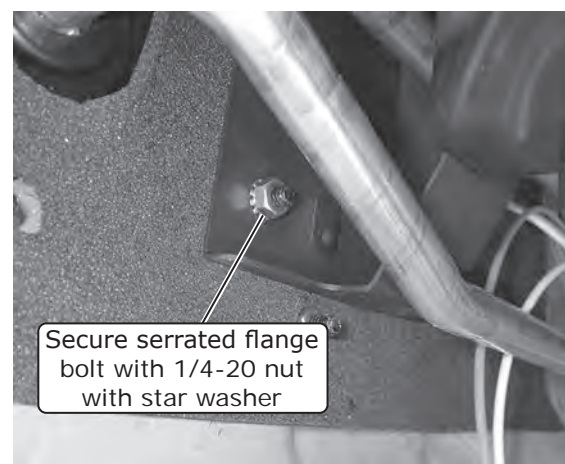

Secure serrated flange bolt with 1/4-20 nut with star washer

Passenger Compartment View

Photo 10



www.vintageair.com

Drain Hose Installation

1. Cut the drain hose 8" long, then install the drain elbow and remaining portion of drain hose (See Photo 1, below).
2. Install the 8" side of the drain hose onto the drain on the bottom of the evaporator module, then through the previously drilled 5/8" hole (See Photo 2, below).

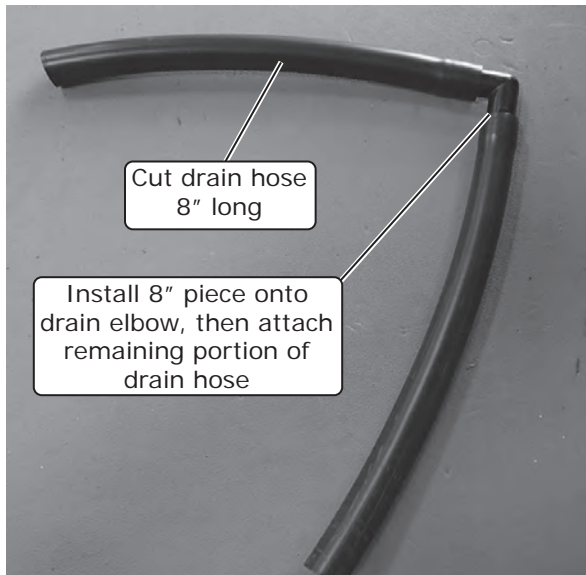

Photo 1

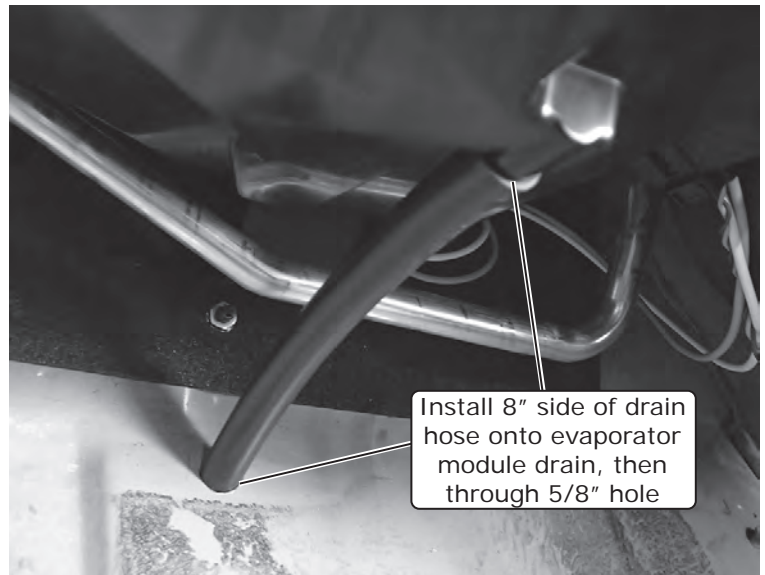

Photo 2

A/C Hose Installation

Standard Hose Kit:

1. Locate the #8 compressor A/C hose. Lubricate (2) #8 O-rings (See Lubricating O-rings, Page 8) and connect the #8 135° female fitting with service port to the #8 discharge port on the compressor. Then route the straight female fitting to the #8 condenser hardline coming through the core support (See Figure 1, Page 19). Tighten each fitting connection as shown in Lubricating O-rings, Page 8.
2. Locate the #10 compressor A/C hose. Lubricate (2) #10 O-rings (See Lubricating O-rings, Page 8) and connect the #10 135° female fitting with service port to the #10 suction port on the compressor. Then route the 90° female fitting to the #10 evaporator hardline coming through the firewall cover (See Figure 1, Page 18, and Figure 1, Page 19). Tighten each fitting connection as shown in Lubricating O-rings, Page 8.
3. Locate the #6 evaporator A/C hose. Lubricate (2) #6 O-rings (See Lubricating O-rings, Page 8) and connect the straight female fitting to the #6 condenser hardline coming through the core support. Then route the 90° female fitting to the #6 hardline coming through the firewall cover (See Figure 1, Page 18, and Figure 1, Page 19). Tighten each fitting connection as shown in Lubricating O-rings, Page 8.

Modified Hose Kit:

1. Refer to separate instructions included with modified hose kit.



www.vintageair.com

Heater Hose & Heater Control Valve Installation

NOTE: Vintage Air systems use 5/8" heater connections. On engines equipped with 3/4" hose nipples, these will need to be removed and replaced with 5/8" nipples (not supplied). For water pumps with a cast-in 3/4" heater outlet, a 3/4" x 5/8" reducer fitting in the heater hose (not supplied) or molded hose (Vintage Air Part # 099010) will need to be installed.

1. Route a length of heater hose from the upper heater hardline to the water pump fitting, and secure it using (2) hose clamps (See Figure 1, below, and Figure 1, Page 19).
2. Cut a length of heater hose approximately 4" to 5" from the firewall cover, then install it onto the lower heater hardline. Install the heater control valve and secure with (2) hose clamps (See Figure 1, below).
NOTE: Ensure proper flow direction through the heater control valve. The flow direction follows the molded arrow on the valve (See Figure 1, below).
3. Install another length of heater hose from the heater control valve to the intake, then secure it with (2) hose clamps (See Figure 1, below, and Figure 1, Page 19).
4. Plug the heater control valve connector into the heater control valve connector wiring harness.

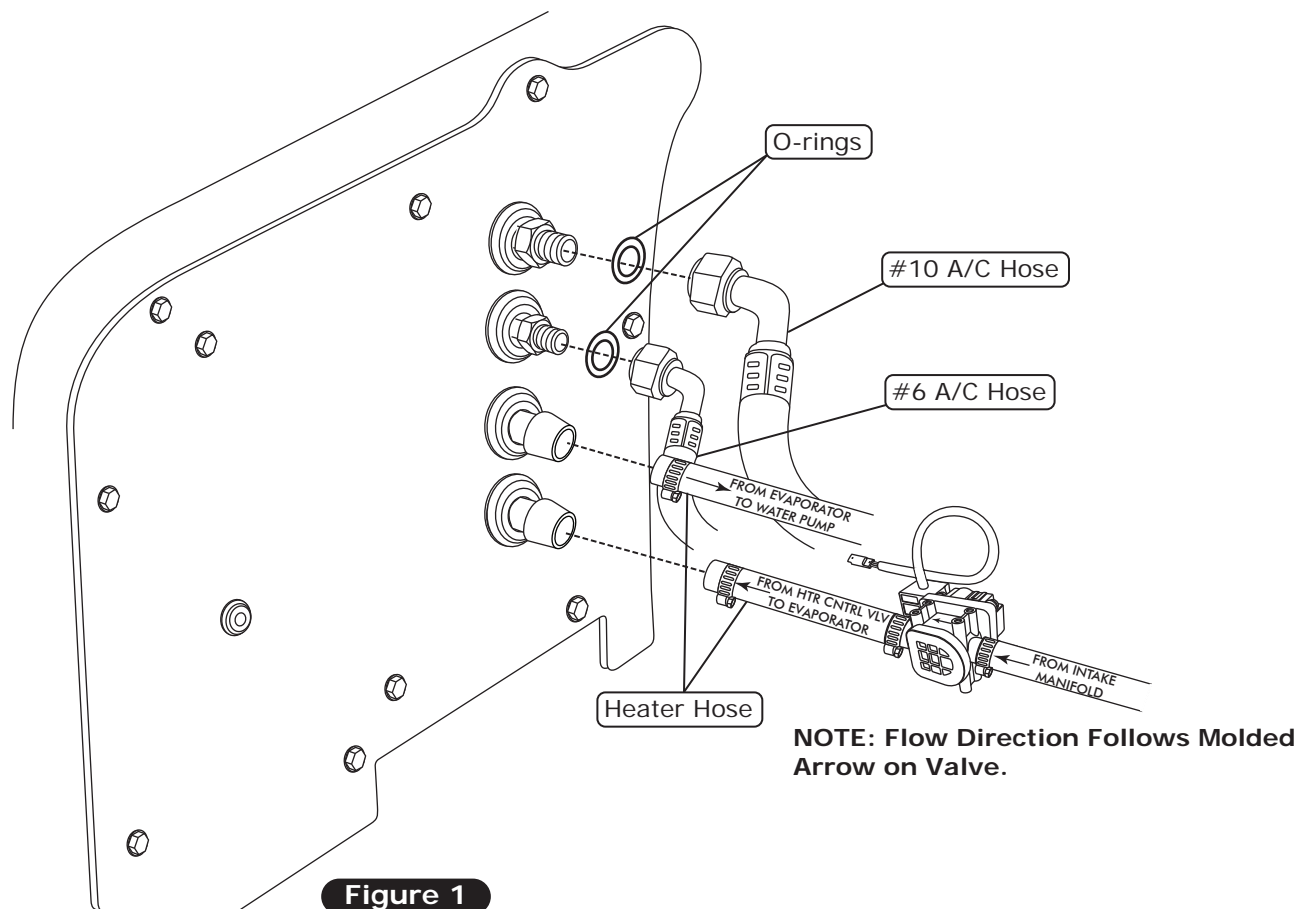



www.vintageair.com

A/C and Heater Hose Routing

NOTE: Vintage Air Systems use 5/8" heater connections. On engines equipped with 3/4" hose nipples, these will need to be removed and replaced with 5/8" nipples (not supplied). For water pumps with a cast-in 3/4" heater outlet, a 3/4" x 5/8" reducer fitting in the heater hose (not supplied) or molded hose (Vintage Air Part # 099010) will need to be installed.

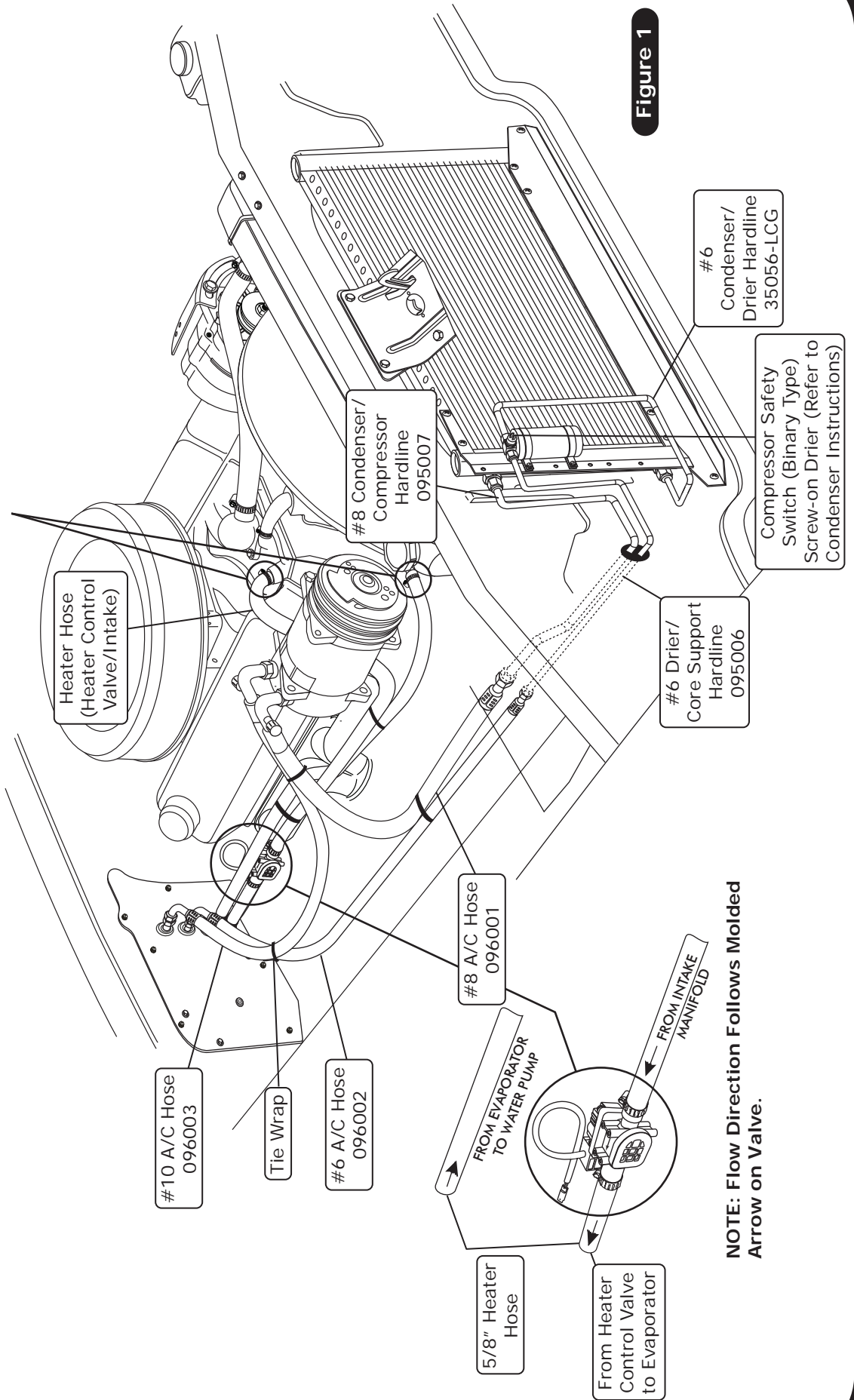

Figure 1

NOTE: Flow Direction Follows Molded Arrow on Valve.

Passenger Compartment Wiring

1. Route the violet power wire to a switched 12v power source on the fuse panel (See Photo 1, below).
NOTE: This requires a male fuse extension (not supplied).
2. Connect the tan wire to the factory dash lights to enable control panel backlighting (if applicable).
3. Connect the BSC wiring to the main harness (See Photo 2, below).
4. Connect the main harness to the ECU (See Photo 3, below).



Photo 1

Attach Violet Wire to Switched Power Source

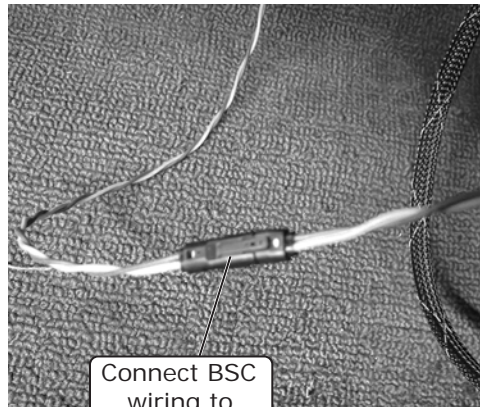

Connect BSC wiring to main harness

Photo 2

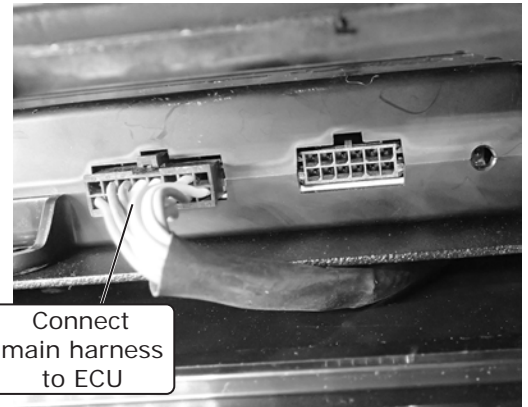

Connect main harness to ECU

Photo 3

Engine Compartment Wiring

1. Route all wiring towards the battery area.
2. Secure the blue lead from the main wiring harness to the #6 A/C hose with the supplied tie wraps.
3. Route the blue lead through the core support grommet toward the safety switch on the drier.
4. Strip the blue lead and crimp the supplied 1/4" female terminal onto it. Connect the terminal to the safety switch on the drier (See Photo 1, below).
5. Connect the compressor bullet connector to the compressor lead (See Photo 2, below).

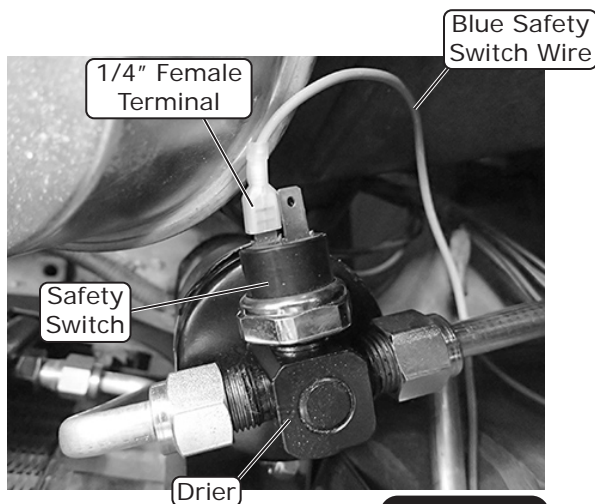

Photo 1

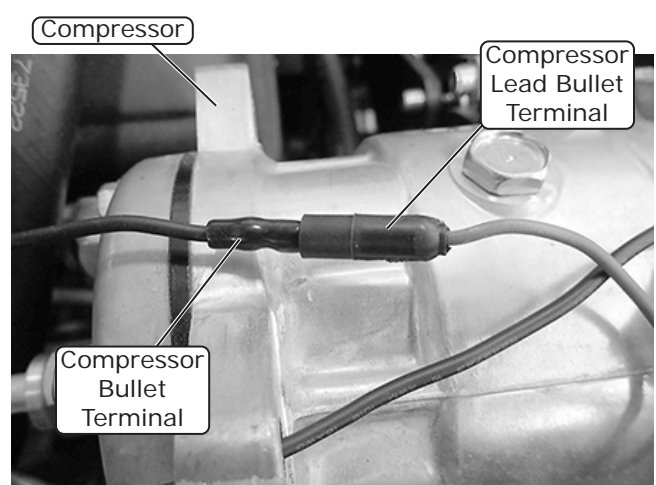

Photo 2



www.vintageair.com

Engine Compartment Wiring (Cont.)

6. Route power and ground wires toward the battery.
 7. Install the supplied heat shrink over the 12 AWG orange fuse holder assembly wire, and crimp it to the 12 AWG orange wire from the main wiring harness (See Photo 3, below and Quality Crimp Guidelines, Page 25).
 8. Install the supplied heat shrink over the 16 AWG black fuse holder assembly wire, and crimp it to the 16 AWG red wire from the main wiring harness (See Photo 4, below and Quality Crimp Guidelines, Page 25).
 9. Install fuses into the holders (See Photo 5, below).
 10. Install the supplied heat shrink over the white ground wires, then crimp on the supplied eyelets (See Photos 6 and 7, below and Quality Crimp Guidelines, Page 25)
 11. Connect the ground wiring eyelets to the negative battery terminal connector (See Photo 8, below).
 12. Connect the positive wiring eyelets to the positive battery terminal connector (See Photo 9, below).
- NOTE: Do not connect power until installation is completed.**

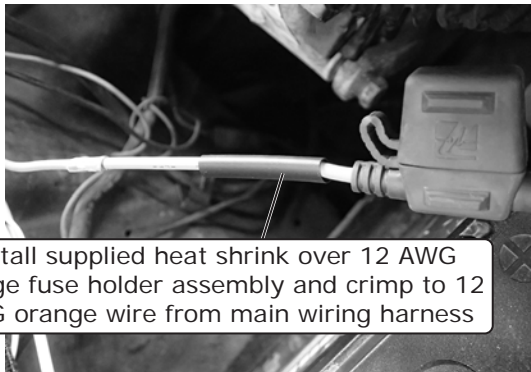

Install supplied heat shrink over 12 AWG orange fuse holder assembly and crimp to 12 AWG orange wire from main wiring harness

Photo 3

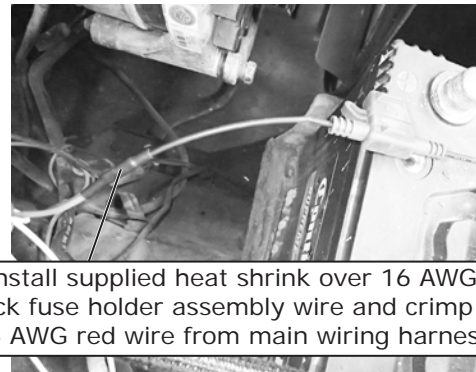

Install supplied heat shrink over 16 AWG black fuse holder assembly wire and crimp to 16 AWG red wire from main wiring harness

Photo 4



Install fuses into holders

Photo 5

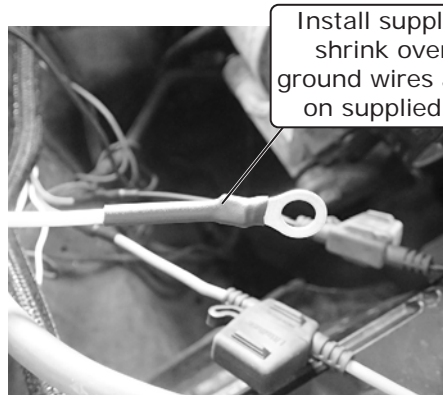

Install supplied heat shrink over white ground wires and crimp on supplied eyelets

Photo 6

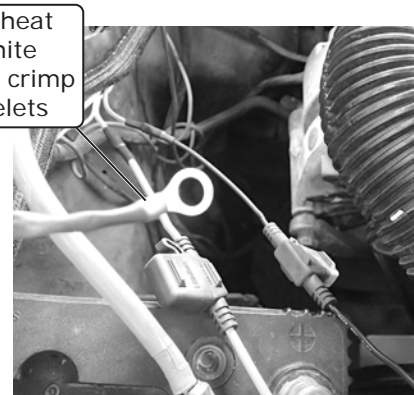
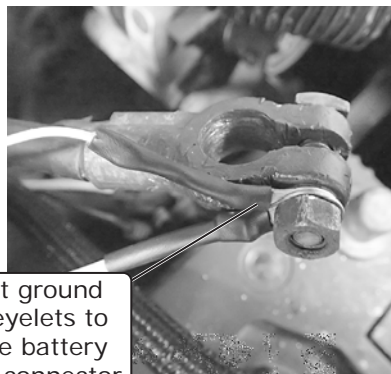
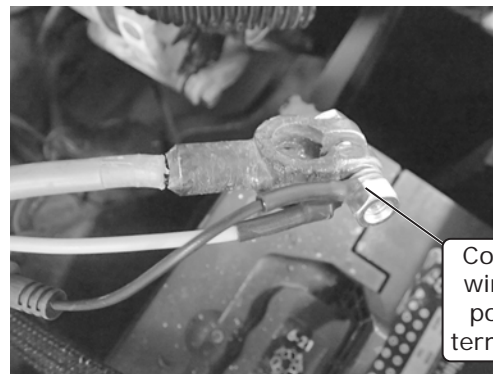

Photo 7



Connect ground wiring eyelets to negative battery terminal connector

Photo 8



Connect positive wiring eyelets to positive battery terminal connector

Photo 9

NOTE: Do not connect power until installation is completed.



www.vintageair.com

ECU, Control Panel & Duct Hose Routing

NOTE: For the system to function optimally, the duct hoses must be routed as directly as possible, taking care to avoid kinks, sharp bends and unnecessary length. Vintage Air supplies duct hoses in continuous lengths that will need to be cut to size depending on application. Before cutting, familiarize yourself with the installation instructions and verify the routing will work with your application. For custom hose routing, additional hose may be needed and can be purchased from Vintage Air.

1. Stretch the duct hose until there is no slack, measure, mark and cut hose to size (See Photo 1, below).

Stretch, measure, mark and cut hose to size



Photo 1

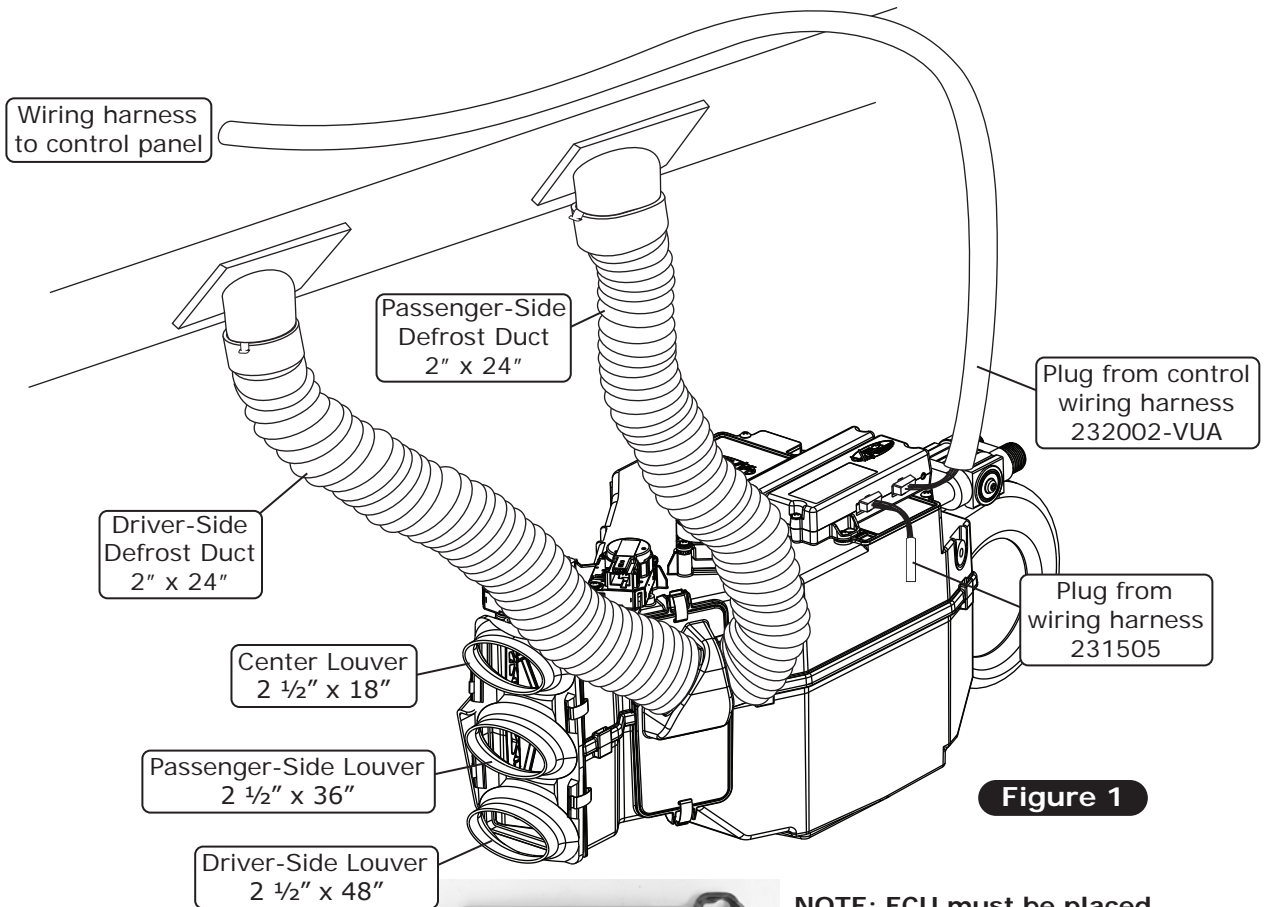

Figure 1



NOTE: ECU must be placed away from water and humidity, and also be accessible for servicing. If relocating, connectors must be positioned towards the bottom.

Position connectors towards bottom



www.vintageair.com

Final Steps: Installation Check

Installation Check	
ITEM TO CHECK	Procedure
<input type="checkbox"/>	<p>ECU</p> <p>If no blinking is observed after 1 minute of turning the ignition on, go to the next check.</p> <p>If repetitive blinking is observed, go to the Advanced Diagnostics Section to diagnose.</p>
<input type="checkbox"/>	<p>Blower speed control</p> <p>Set the blower speed control to OFF, <u>confirm that the blower is off</u>.</p> <p>Position the blower speed control to LOW then MEDIUM and then HIGH. <u>At each setting confirm that the blower speed increases</u>, do this by feeling for the amount of air coming from the unit and hearing the blower speed increase.</p>
<input type="checkbox"/>	<p>Mode control</p> <p>Set the MODE control to the DASH position. <u>Confirm that air is being blown at the dash vents</u>.</p> <p>Set the MODE control to the FLOOR position. <u>Confirm that air is being blown at the floor vents</u>.</p> <p>Set the MODE control to the DEFROST position. <u>Confirm that all air is being blown from the defrost vents</u></p> <p>If heater lines are installed:</p> <p>Set the MODE control to the DASH position. Set the TEMP control to the MAX HEAT position. <u>Confirm that HOT air is coming from the dash vents</u>.</p>
<input type="checkbox"/>	<p>Temperature control</p> <p>If system is charged:</p> <p>Set the TEMP control to the MAX COOL position. <u>Confirm that COLD air is coming from the dash vents</u>.</p> <p>Also <u>confirm that the compressor "clicks" on</u> when adjusting the TEMP control from the MAX HEAT position to the MAX COOL position.</p>
<input type="checkbox"/>	<p>AC Indicator (If applicable)</p> <p>While the MODE control is set to the DASH position, and the TEMP control is set to the MAX COOL/MIN HEAT position, <u>confirm that the blue AC Indicator light is on</u>.</p>
<input type="checkbox"/>	<p>Backlight (If applicable)</p> <p>If your control panel has backlight capabilities and has been wired, turn the dash lamp on and <u>confirm that the AC panel's legend is lit</u>.</p>
<input type="checkbox"/>	<p>Fittings</p> <p>Verify AC and Heater fittings are all tight.</p>



www.vintageair.com

Final Steps: Completing the Install

1. Install duct hoses as shown in Figure 1, Page 22.
2. Install control panel assembly. Refer to control panel instructions.
3. Install the new glove box using the OEM hardware.
4. Install the glove box door.
5. Reinstall all previously removed items.
6. Fill radiator with at least a 50/50 mixture of approved antifreeze and distilled water. It is the owner's responsibility to keep the freeze protection at the proper level for the climate in which the vehicle is operated. Failure to follow antifreeze recommendations will cause heater core to corrode prematurely and possibly burst in A/C mode and/or freezing weather, voiding your warranty.
7. Double check all fittings, brackets and belts for tightness.
8. Vintage Air recommends that all A/C systems be serviced by a licensed automotive A/C technician.
9. Evacuate the system for a minimum of 45 minutes prior to charging, and perform a leak check prior to servicing.
10. Charge the system to the capacities stated on Page 4 of this instruction manual.
11. See Operation of Controls procedures on Page 28.



www.vintageair.com

Quality Crimp Guideline

Refer to wiring diagram on Page 26, and instructions on Page 27.

Acceptable strip length
(Some copper visible)

Crimped area is centered
on each side of splice

Bad strip length
(Too much copper visible)
Visible copper should be
just enough to ensure
clearance between splice
area and wire insulation

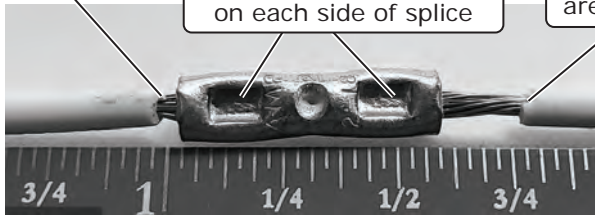

Photo 1

A good crimp requires
seam of butt splice to be
opposite of crimp die tooth



Photo 2

Good Ring Terminal Crimp

Bad Ring Terminal Crimp

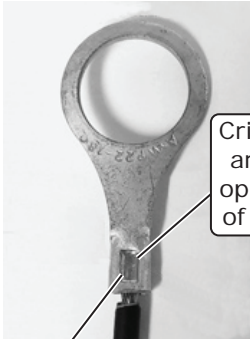

Photo 3

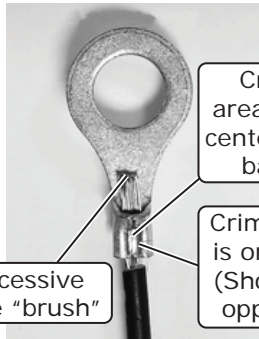

Photo 4

Crimp area is centered on barrel

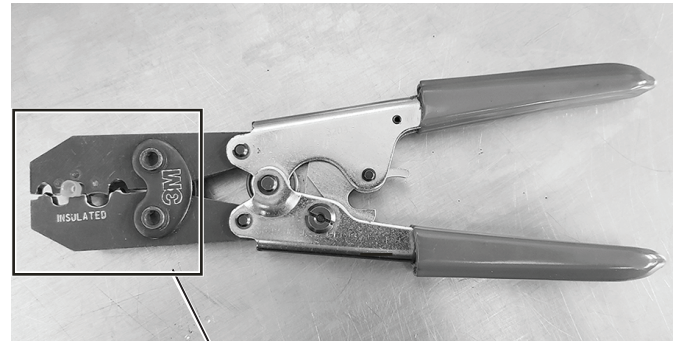

Photo 5

Use a ratcheting crimp tool for insulated barrel terminals when crimping the provided female insulated terminal. Ensure terminal is inserted in appropriate position before crimping.

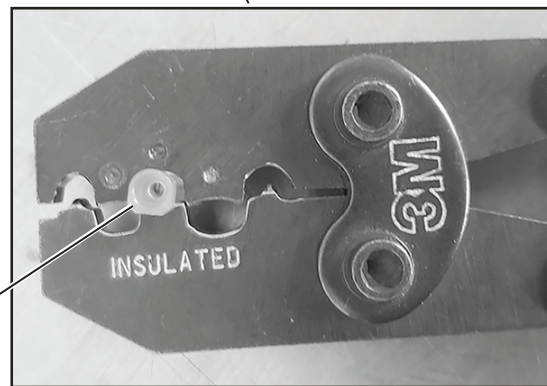
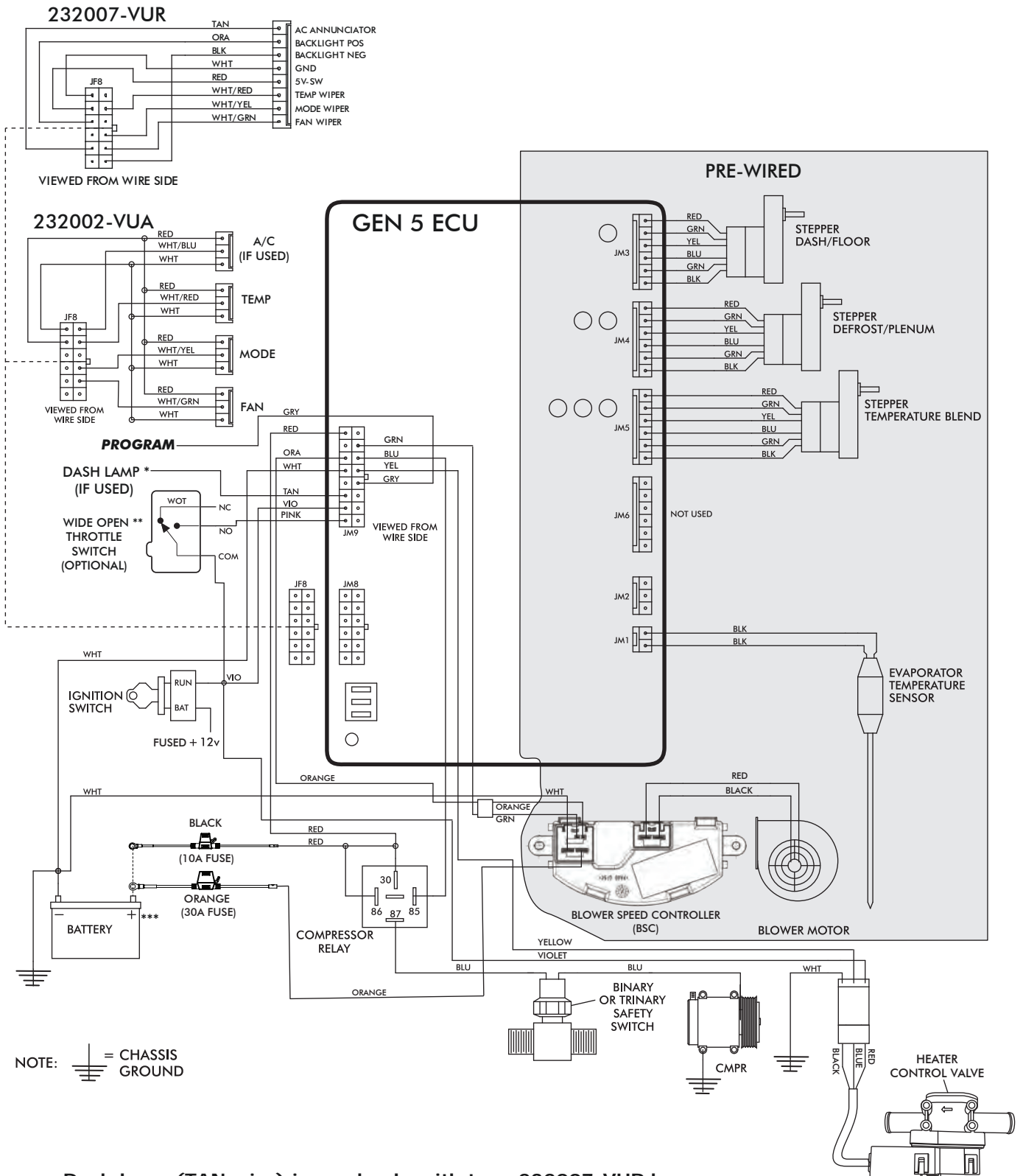

Photo 5a



www.vintageair.com

Gen 5 Wiring Diagram



* Dash lamp (TAN wire) is used only with type 232007-VUR harness.

** Wide open throttle switch contacts close only at full throttle, which disables A/C compressor.

*** Install fuse assemblies at or as near to the battery as possible.



www.vintageair.com

Gen 5 Wiring Instructions

WIRING HARNESS (231505) ↓

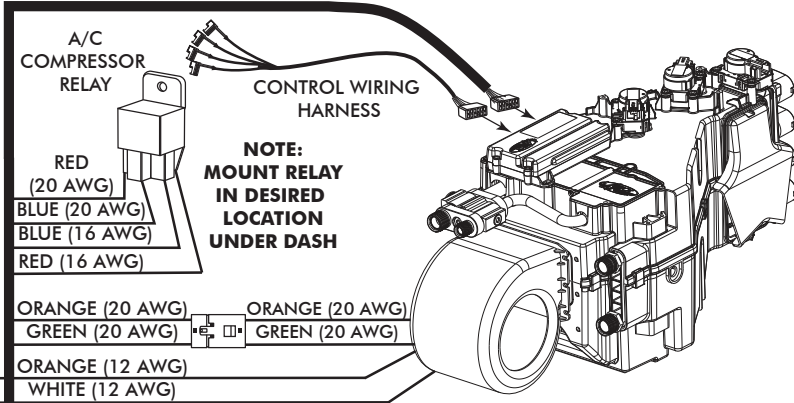

NOTE:
MOUNT RELAY
IN DESIRED
LOCATION
UNDER DASH

Ignition Switch:
Using provided butt splice (PN 226004), connect the 20 AWG violet wire to a 5A fused and switched 12V source such as Key On.

Wide Open Throttle Switch (Optional):
If a wide open throttle switch is required, connect the 20 AWG pink wire to a normally open switch that, when closed, connects a fused and switched 12V source to the pink wire. See Gen 5 wiring diagram for an example.

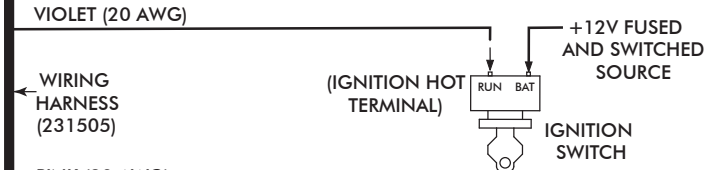

Dash Light (Optional):
If using a Vintage Air control panel with back light, connect the 20 AWG tan wire to the vehicle's dash back light 0-12V using provided butt splice (PN 226004).

WIRING HARNESS (232020)

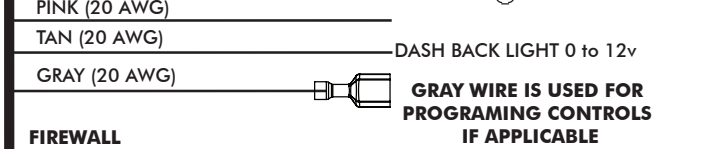

Heater Control Valve:
Connect the Violet/Yellow/White twisted branch with 3 position connector into the heater control valve connector. Ensure that the mating latch is fully seated.

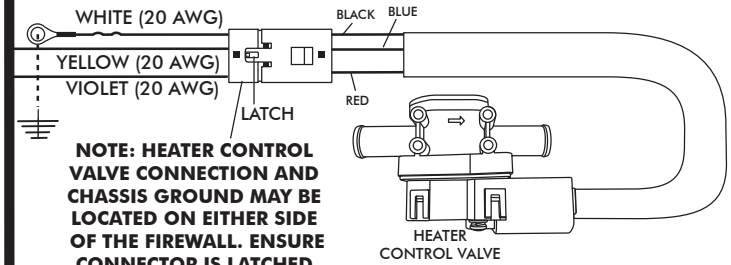

NOTE: HEATER CONTROL VALVE CONNECTION AND CHASSIS GROUND MAY BE LOCATED ON EITHER SIDE OF THE FIREWALL. ENSURE CONNECTOR IS LATCHED FIRMLY.

Binary/Trinary & Compressor:
Binary Switch: Terminate provided insulated female terminal (PN 23172-VUW) to the blue 16 AWG wire. Connect as shown.
Trinary Switch: Connect according to trinary switch wiring diagram.

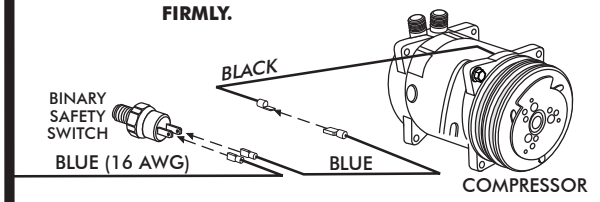

Battery Connections:
ECU Ground: Terminate provided ring terminal (PN 226110) to 20 AWG white wire from the 231505 wire assembly and install at battery.
ECU PWR: Terminate provided fuse assembly with black leads (PN 233012) to the 16 AWG red wire from the 231505 wire assembly. Install provided 10A Red Mini Fuse (PN 226118). Install at battery.
Blower Speed Controller (BSC) Ground: Terminate provided ring terminal (PN 226111) to 12 AWG white wire from the 232020 wire assembly and install at battery.
Blower Speed Controller (BSC) PWR: Terminate provided fuse assembly with orange leads (PN 233008) to the 12 AWG orange wire from the 232020 wire assembly. Install provided 30A Green ATO/ATC Fuse (PN 226125). Install at battery.

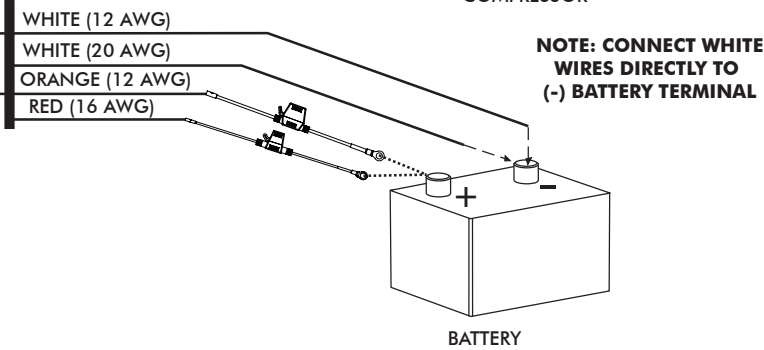



www.vintageair.com

Operation of Controls

On Gen IV or Gen 5 systems with three lever/knob controls, the temperature control toggles between heat and A/C operations. To activate A/C, move the temperature lever/knob all the way to cold and then back it off to the desired vent temperature. For heat operation, move the temperature lever/knob all the way to hot and then adjust to the desired vent temperature. The blower will momentarily change speed, each time you toggle in and out of heat and A/C operations, to indicate the change. **NOTE: For proper control panel function, refer to the control panel instructions for calibration procedure.**

Blower Speed

This lever/knob controls blower speed, from OFF to HI.

Mode Control

This lever/knob controls the mode positions, from DASH to FLOOR to DEFROST, with a blend in between.

Temperature Control

This lever/knob controls the temperature, from HOT to COLD.

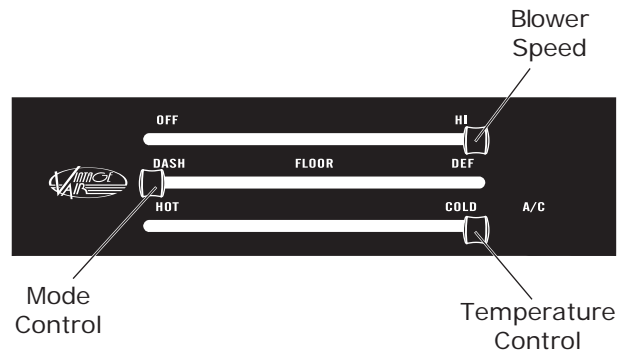

A/C Operation

Blower Speed

Adjust to desired speed.

Mode Control

Adjust to desired mode position (DASH position recommended).

Temperature Control

For A/C operation, adjust to coldest position to engage compressor (adjust between HOT and COLD to reach desired temperature).

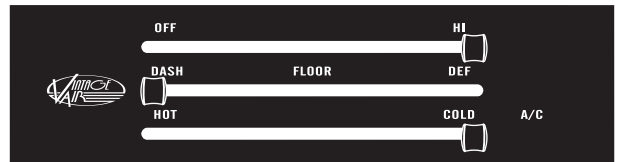

Heat Operation

Blower Speed

Adjust to desired speed.

Mode Control

Adjust to desired mode position (FLOOR position recommended).

Temperature Control

For maximum heating, adjust to hottest position (adjust between HOT and COLD to reach desired temperature).



Defrost/De-fog Operation

Blower Speed

Adjust to desired speed.

Temperature Control

Adjust to desired temperature.

Mode Control

Adjust to DEFROST position for maximum defrost, or between FLOOR and DEFROST positions for a bi-level blend (Compressor is automatically engaged).





www.vintageair.com

Troubleshooting Guide

This printed troubleshooting guide is our basic guide that covers common installation problems. To see our advanced diagnostics and troubleshooting guide, please refer to the following page for instructions on how to download the complete guide.

WARNING: While troubleshooting the system, never probe connector terminals from the front mating side, only back probe.

WARNING: While troubleshooting the system, never use automotive check lights.

Symptom	Condition	Checks	Actions	Notes
1. Blower stays on high speed with ignition on.	No other functions work.	Check for damaged pins or wires in the control panel wire assembly and mating header at ECU.	If found damaged, replace wire assembly or ECU.	If fuse continues to blow, there is a serious problem in the wiring. Check all wiring and ensure the wire is not damaged and shorting out along its route.
	All other functions work.	Check for a bad ECU GND. Check for damaged pins or wires in the control panel wire assembly and mating header at ECU. Check if Blower power fuse is blown. Check for a bad ECU GND.	If found damaged, replace wire assembly or ECU. Replace fuse. Repair connection.	
2. Compressor will not turn on (All other functions work).	System is not charged.	System must be charged for compressor to engage.	Charge system.	Danger: Never bypass safety switch with engine running. Serious injury can result.
	System is charged.	Check for faulty A/C potentiometer or associated wiring (not applicable to 3-pot controls). Check for disconnected or faulty thermistor.	Check continuity to ground on white control head wire. Check for 5V on red control head wire. Check 2-pin connector at ECU housing.	To check for proper pot function, check voltage at white/red wire. Voltage should be between 0V and 5V, and will vary with pot lever position. Disconnected or faulty thermistor will cause compressor to be disabled.
	Compressor will not turn off (All other functions work).	Check for faulty A/C potentiometer or associated wiring.	Repair or replace pot/control wiring.	Red wire at A/C pot should have approximately 5V with ignition on. White wire will have continuity to chassis ground. White/Red wire should vary between 0V and 5V when lever is moved up or down.
3. Compressor will not turn off (All other functions work).	Compressor will not turn off (All other functions work).	Check for faulty A/C relay.	Replace relay.	



www.vintageair.com

Troubleshooting Guide (Cont.)

Symptom	Condition	Checks	Actions	Notes
4. System will not turn on, or runs intermittently.	Works when engine is not running; shuts off when engine is started	Noise interference from either ignition or alternator.	Install capacitors on ignition coil and alternator. Ensure good ground at all points. Relocate coil and associated wiring away from ECU and ECU wiring. Check for burned or loose plug wires.	Ignition noise (radiated or conducted) will cause the system to shut down due to high voltage spikes. If this is suspected, check with a quality oscilloscope. Spikes greater than 16V will shut down the ECU. Install a radio capacitor at the positive post of the ignition coil (see radio capacitor installation bulletin). A faulty alternator or worn out battery can also result in this condition.
	Will not turn on under any conditions.	Verify connections on power lead, ignition lead, and both white ground wires. Verify battery voltage is greater than 10 volts and less than 16 while engine is running.	Check for power at ECU, and confirm ignition is being applied to ECU properly. Verify proper meter function by checking the condition of a known good battery.	
5. Loss of mode door function.	No mode change at all.	Check for damaged mode switch or potentiometer and associated wiring.		
	Blower turns on and off rapidly.	Battery voltage is at least 12V. Battery voltage is less than 12V.	Ensure all system grounds and power connections are clean and tight. Charge battery.	System shuts off blower at 10V. Poor connections or weak battery can cause shutdown at up to 11V.
7. Erratic functions of blower, mode, temp, etc.		Check for damaged switch or pot and associated wiring.	Repair or replace.	

Advanced Diagnostics and Troubleshooting Guide

If after referencing the Troubleshooting Guide, the issue is not resolved, move to The Advanced Diagnostics and Troubleshooting Guide that covers the following:

- **ECU Diagnostics Codes**
 1. ECU Blink Sequence
 2. Firmware Version Number
 3. ECU Model Number
 4. ECU Start-Up Blink Sequence
 5. Diagnostic Codes
- **Complete Advanced Troubleshooting Guidelines**

Access the latest version of the Advanced Diagnostics and Troubleshooting Guide by scanning the following QR code on your mobile device:



You can also access the guide by typing the following address into your web browser:

https://www.vintageair.com/instructions_pdf/905000.pdf



www.vintageair.com

Packing List: Evaporator Kit (755606)

No.	Qty.	Part No.	Description
1.	1	765200	Gen 5 Super Magnum Module
2.	1	795606	Accessory Kit

Checked By: _____
Packed By: _____
Date: _____

1



Gen 5 Super Magnum
Module
765200

2

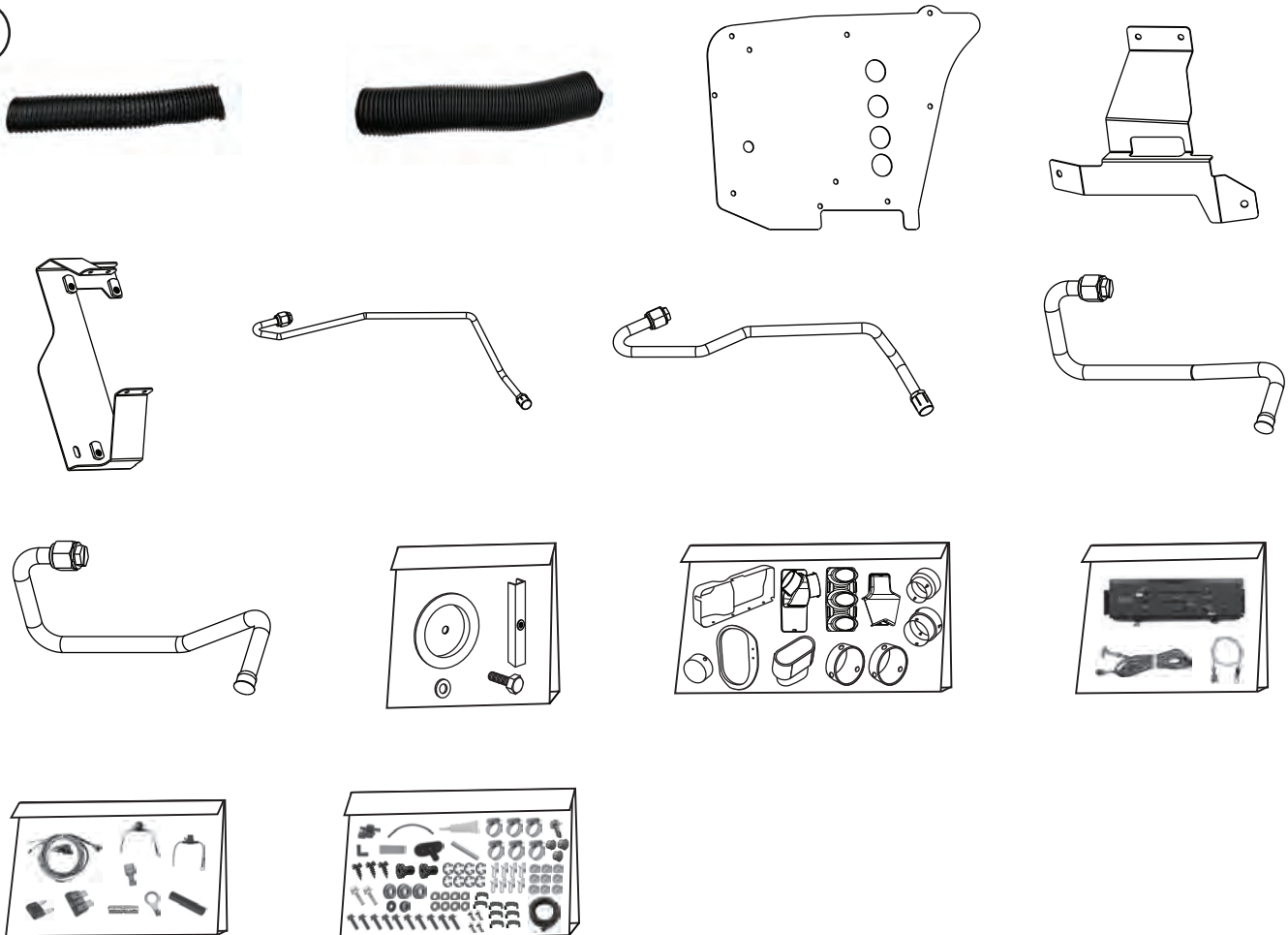

Accessory Kit
795606

**NOTE: Images may not depict actual parts and quantities.
Refer to packing list for actual parts and quantities.**