



1988-94 Chevrolet Pickup

with Factory Air
Gen 5 Evaporator Kit
(755737)



18865 Goll St. San Antonio, TX 78266
Phone: 800-862-6658
Sales: sales@vintageair.com
Tech Support: tech@vintageair.com
www.vintageair.com



www.vintageair.com

Table of Contents

Cover..... 1

Table of Contents..... 2

Packing List/Parts Disclaimer..... 3

Information Page.....4

Wiring Notice..... 5

Engine Compartment Disassembly, Passenger Compartment Disassembly, Condenser Assembly and Installation, Compressor and Brackets..... 6-9

Firewall Modification and Insulation, Fresh Air Vent Cover Installation..... 10-11

Evaporator Module Preparation..... 12

Lubricating O-rings, Passenger Compartment A/C Hose Installation..... 13

Heater Hose Installation, Rubber Boot Installation, Wiring Installation: Part 1..... 14

Evaporator Installation, Evaporator Leveling, Drain Hose Installation..... 15-16

A/C Hose Installation..... 17

Heater Hose & Heater Control Valve Installation..... 18

Wiring Installation: Part 2..... 19

Final Steps: Installation Check..... 20

5 Outlet Hose Adapter Installation, Dash Reinstallation..... 21

Duct Hose Routing..... 22

Final Steps: Completing the Install..... 23

Quality Crimp Guideline.....24

Gen 5 Wiring Diagram.....25

Gen 5 Wiring Connection Instruction..... 26

Operation of Controls..... 27

Troubleshooting Guide.....28

Troubleshooting Guide (Cont.), Advanced Diagnostics and Troubleshooting Guide..... 29

Packing List..... 30



www.vintageair.com

Packing List: Evaporator Kit (755737)

No.	Qty.	Part No.	Description
1.	1	765200	Gen 5 Super Magnum Module
2.	1	795737	Accessory Kit

**** Before beginning installation, open all packages and check contents of shipment. Please report any shortages directly to Vintage Air within 15 days. After 15 days, Vintage Air will not be responsible for missing or damaged items.**

1



Gen 5 Super
Magnum Module
765200

2

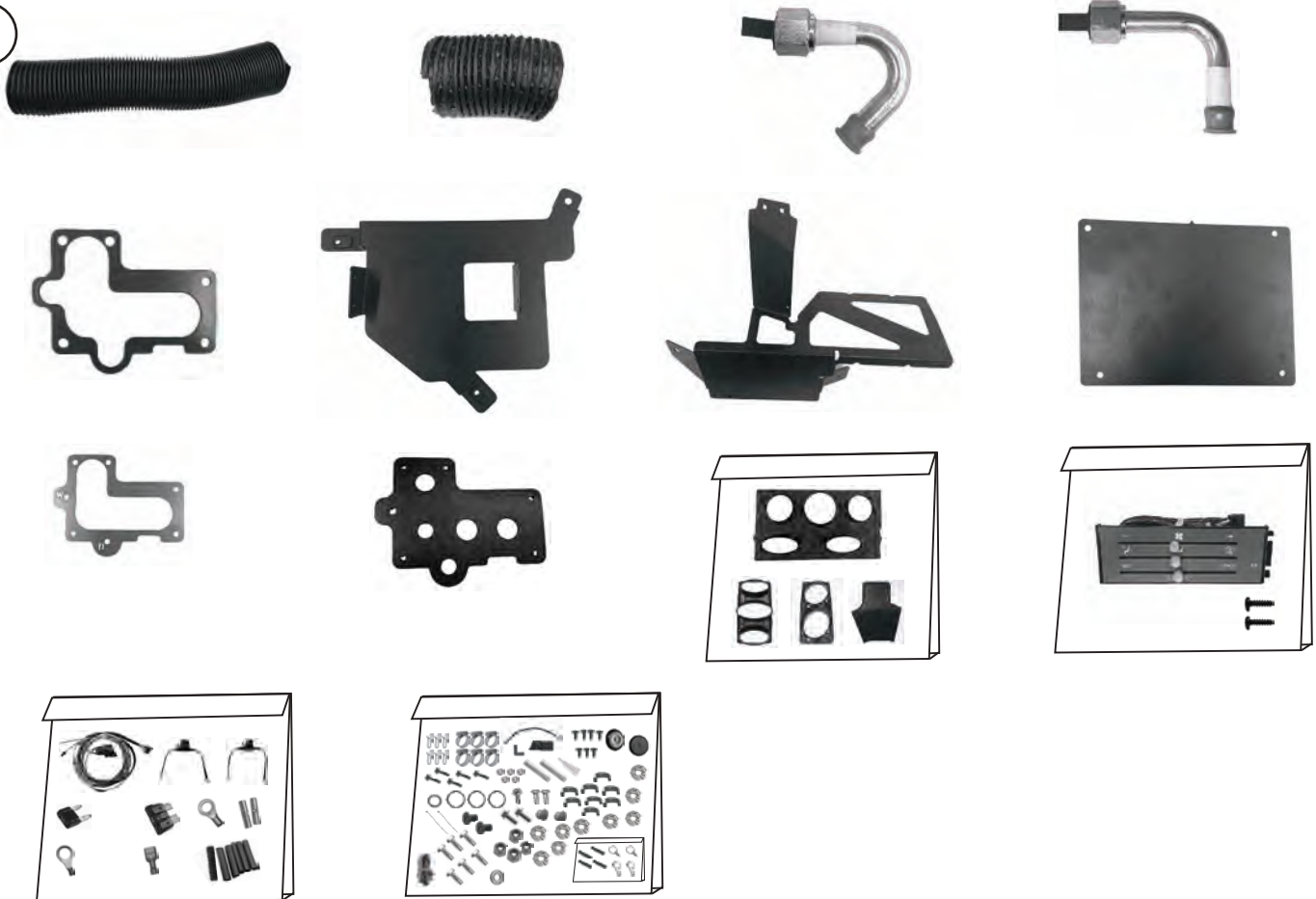

Accessory Kit
795737

NOTE: Images may not depict actual parts and quantities. Refer to packing list for actual parts and quantities.



www.vintageair.com

Important Notice—Please Read

For Maximum System Performance, Vintage Air Recommends the Following:

NOTE: Vintage Air systems are designed to operate with R134a refrigerant only. Use of any other refrigerant could damage your A/C system and/or vehicle, and possibly cause a fire, in addition to potentially voiding the warranties of the A/C system and its components.

Refrigerant Capacities:

Vintage Air System: 1.8 lbs. (28.8 oz.) or 816 grams of **R134a**, charged by weight with a quality charging station or scale. **NOTE: Use of the proper type and amount of refrigerant is critical to system operation and performance.**

Other Systems: Consult manufacturer's guidelines.

Lubricant Capacities:

New Vintage Air-Supplied Sanden Compressor: No additional oil needed (Compressor is shipped with proper oil charge).

All Other Compressors: Consult manufacturer (Some compressors are shipped dry and will need oil added).

Safety Switches

Your Vintage Air system is equipped with a binary pressure safety switch. A binary switch disengages the compressor clutch in cases of extreme low pressure conditions (refrigerant loss) or excessively high head pressure (406 PSI) to prevent compressor damage or hose rupture. A trinary switch combines Hi/Lo pressure protection with an electric fan operation signal at 254 PSI, and should be substituted for use with electric fans. Compressor safety switches are extremely important since an A/C system relies on refrigerant to circulate lubricant.

Service Info:

Protect Your Investment: Prior to assembly, it is critical that the compressor, evaporator, A/C hoses and fittings, hardlines, condenser and receiver/drier remain capped. Removing caps prior to assembly will allow moisture, insects and debris into the components, possibly leading to reduced performance and/or premature failure of your A/C system. This is especially important with the receiver/drier.

Additionally, when caps are removed for assembly, **BE CAREFUL!** Some components are shipped under pressure with dry nitrogen.

Evacuate the System for 35-45 Minutes: Ensure that system components (Drier, compressor, evaporator and condenser) are at a temperature of at least 85°F. On a cool day, the components can be heated with a heat gun **or** by running the engine with the heater on before evacuating. Leak check and charge to specifications.

Bolts Passing Through Cowl and/or Firewall:

To ensure a watertight seal between the passenger compartment and the vehicle exterior, for all bolts passing through the cowl and/or firewall, Vintage Air recommends coating the threads with silicone prior to installation.

Heater Hose (not included with this kit):

Heater hose may be purchased from Vintage Air (Part#31800-VUD) or your local parts retailer. Routing and required length will vary based on installer preference.



www.vintageair.com

Important Wiring Notice—Please Read

Some vehicles may have had some or all of their radio interference capacitors removed. There should be a capacitor found at each of the following locations:

- 1. On the positive terminal of the ignition coil.**
- 2. If there is a generator, on the armature terminal of the generator.**
- 3. If there is a generator, on the battery terminal of the voltage regulator.**

Most alternators have a capacitor installed internally to eliminate what is called “whining” as the engine is revved. If whining is heard in the radio, or just to be extra cautious, a radio interference capacitor can be added to the battery terminal of the alternator.

It is also important that the battery lead is in good shape and that the ground leads are not compromised. There should be a heavy ground from the battery to the engine block, and additional grounds to the body and chassis.

If these precautions are not observed, it is possible for voltage spikes to be present on the battery leads. These spikes come from ignition systems and charging systems, and from switching some of the vehicle’s other systems on and off. Modern computer-operated equipment can be sensitive to voltage spikes on the power leads, which can cause unexpected resets, strange behavior and/or permanent damage.

Vintage Air strives to harden our products against these types of electrical noise, but there is a point where a vehicle’s electrical system can be degraded so much that nothing can help.

Radio interference capacitors should be available at most auto and truck parts suppliers. They typically are cylindrical in shape, a little over an inch long and a little over a half-inch in diameter, and they have a single lead coming from one end of the cylinder with a terminal on the end of the wire, as well as a mounting clip which is screwed into a good ground on the vehicle. The specific value of the capacitance is not too significant in comparison to ignition capacitors that are matched with the coil to reduce pitting of the points.

- Care must be taken, when installing the compressor lead, not to short it to ground. The compressor lead must not be connected to a condenser fan or to any other auxiliary device. Shorting to ground or connecting to a condenser fan or any other auxiliary device may damage wiring or the compressor relay, and/or cause a malfunction.
- When installing ground leads on Gen 5 systems, the blower control ground and ECU ground must be connected directly to the negative battery post.
- For proper system operation, the heater control valve must be connected to the ECU.



www.vintageair.com

Engine Compartment Disassembly

NOTE: Before starting the installation, check the function of the vehicle (horn, lights, etc.) for proper operation, and study the instructions, illustrations, photos & diagrams. Retain OEM bolts, washers and nuts, as some hardware will be reused.

Perform the Following:

1. Disconnect the battery.
2. Evacuate the A/C system (if necessary).
3. Drain the radiator.
4. Remove the (2) nuts on top of the air cleaner to remove the air cleaner and air intake box (See Photo 1, below).
5. Remove the (2) bolts holding the coolant overflow reservoir, then remove it to gain access to the bolts holding the stock evaporator module (See Photo 2, below).
6. Unclip the connection going to the accumulator (See Photo 3, below).
7. Remove the #10 hose from the front of the accumulator, then remove the nut on the line coming from the firewall (See Photo 3, below). Next, remove the hardware holding the accumulator bracket to the firewall (See Photo 4, below). Remove the bracket and the accumulator.
8. Remove the heater hoses from the firewall, back of the intake, and the radiator (See Photos 5 and 6, below).



Photo 1



Photo 2

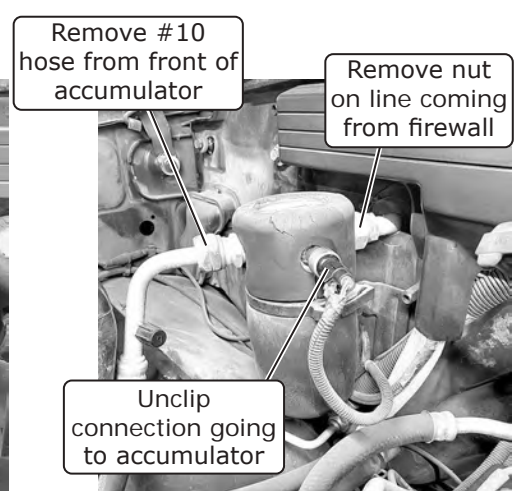

Photo 3



Photo 4

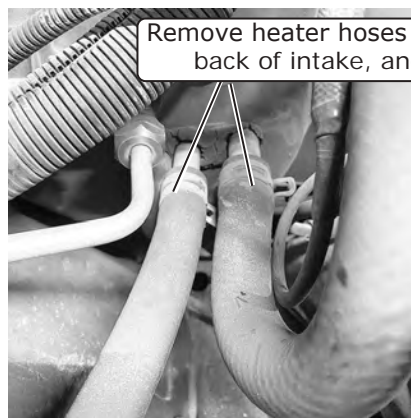

Photo 5

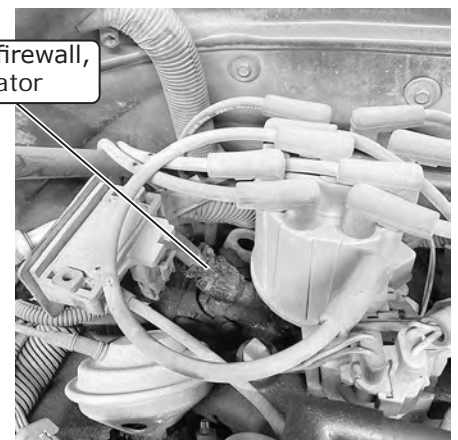

Photo 6

Engine Compartment Disassembly (Cont.)

9. Remove the (5) screws in the firewall that go through into the evaporator module (See Photo 7, below).
10. On the driver side, remove the middle bolt holding the wiring harness plug to the outside of the firewall (See Photo 8, below). Next, remove the (2) screws holding the other side of the plug to the inside of the firewall (See Photo 9, below).



Photo 7



Photo 8

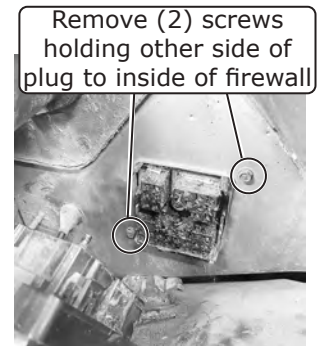

Photo 9

Passenger Compartment Disassembly

NOTE: The removal of the dash is required to remove the OEM evaporator module from the vehicle. Refer to the vehicle shop manual for more detailed information. Retain OEM bolts, washers and nuts, as some hardware will be reused.

1. Remove the (2) screws holding the trim underneath the steering column (See Photo 1, below).
2. Remove the (2) bolts holding the steering column, then lower it (See Photo 2, below).
3. Remove the middle section of the dash and the middle vents by sliding it up, pulling the bottom outward, and pulling out the clips on top.
4. Remove the (2) screws holding in the equalizer module (cassette deck) (See Photo 3, below). Be sure to disconnect any cables that may be connected behind it, then remove the module.

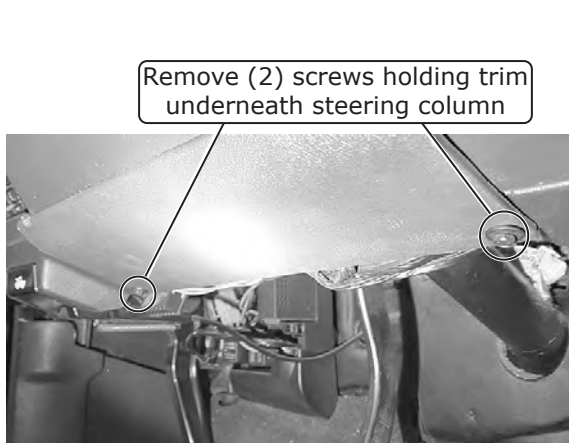

Photo 1

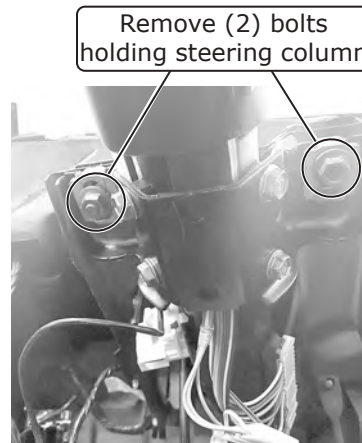

Photo 2



Photo 3

Passenger Compartment Disassembly (Cont.)

5. Unclip the cables on the inside of the glovebox door to remove it. Remove the (4) screws holding the glovebox, then remove it (See Photo 4, below).
6. Remove the far-right vent by removing the (2) screws and unclipping it (See Photo 4, below).
7. Remove the (4) screws holding the dash bezel, then remove it (See Photo 5, below). Disconnect the light switches, dimmer and fog lamps if equipped.
8. Remove the (4) screws holding the A/C controls (See Photo 6, below) and the (4) screws holding the radio (See Photo 7, below). Unclip the connections on the back, then remove the controls and radio.
9. Remove the (2) screws on the rocker panel trim to loosen the kick panel, then remove the kick panel by unclipping it from the back (See Photo 8, below).

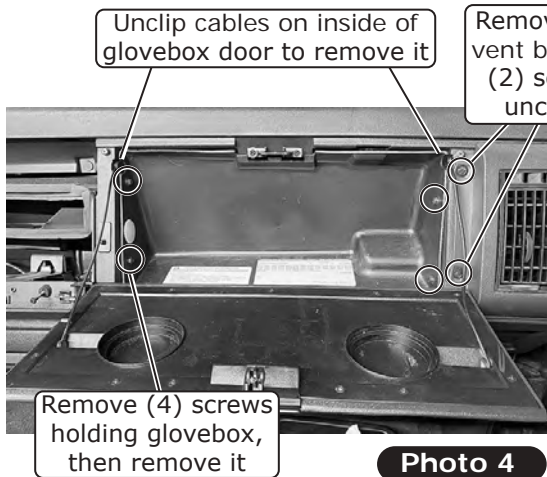

Photo 4



Photo 5

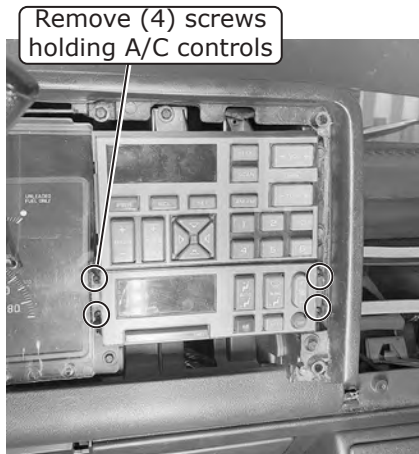

Photo 6

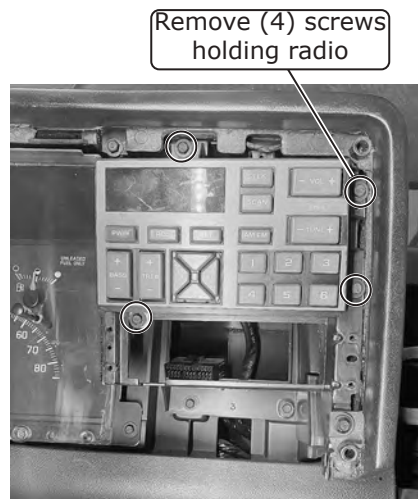

Photo 7

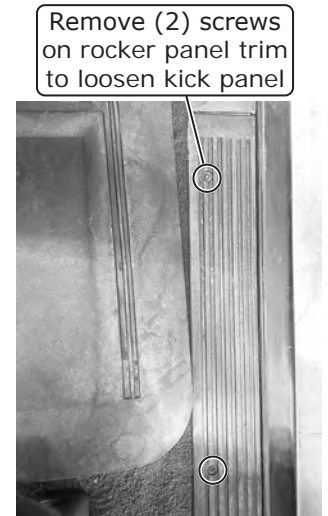

Photo 8

Passenger Compartment Disassembly (Cont.)

10. Remove the dash speaker covers.
11. Remove both dash mounting bolts from the speaker pods and the (3) from the defrost (See Photos 9 and 10, below).
12. Remove the (2) bolts on either side of the dash on the inside to move the dash forward and allow access to the back of it (See Photos 11 and 12, below). Unplug any connection from the dash to the firewall and steering column, then remove dash.
13. Remove the stock engine ECU from its mounting bracket, then unplug it.
14. Remove the (3) connections that go to the stock evaporator module (See Photo 13, below).
15. Remove the last screw holding the stock evaporator module to the firewall, then remove it (See Photo 14, below).

Remove dash mounting bolts from speaker pods



Photo 9

Remove (3) dash mounting bolts from defrost

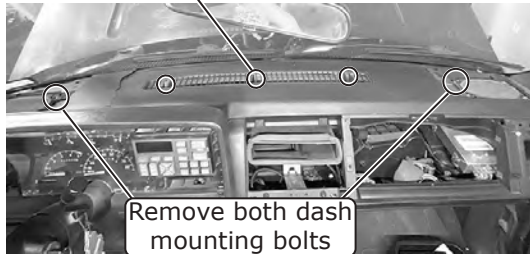

Photo 10

Remove bolt on either side of dash



Photo 11

Remove bolt on either side of dash

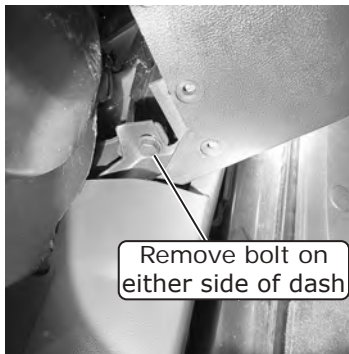

Photo 12

Remove (3) connections that go to stock evaporator module



Photo 13

Remove last screw holding stock evaporator module to firewall, then remove it



Photo 14

Condenser Assembly and Installation

1. Refer to separate instructions included with the condenser kit to install the condenser.

Compressor and Brackets

1. Refer to separate instructions included with the bracket kit to install the compressor bracket.



www.vintageair.com

Firewall Modification and Insulation

NOTE: The OEM insulation won't need to be removed, but will need to be trimmed in some areas. If you do not have insulation, Vintage Air recommends using heat blocking insulation around the evaporator.

1. Align the firewall template with the stock opening, then secure it with a clamp. Mark the (7) spots to drill out for the firewall cover, drain hose and wiring holes (See Photos 1 and 2, below).
2. Drill the holes out with a 13/64" drill bit, then remove the template (See Photo 2, below).
3. The wiring hole on the template is designated with a "W" and will need to be drilled out to 1/2" (See Photo 3, below).
4. The drain hose hole on the template is designated with a "D" and will need to be drilled to 5/8" (See Photo 3, below). **NOTE: To ensure a tight fit for the drain hose, do not enlarge the drain hose hole more than 5/8".**
5. Between the stock holes on the firewall, cut out about 3/4" of the firewall to ease the installation of the new hoses (See Photos 4 and 5, below).

Align firewall template with stock opening, then secure it with a clamp



Photo 1

Drill holes out with a 13/64" drill bit

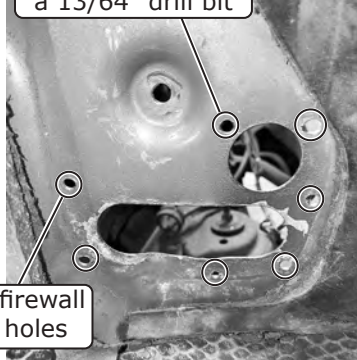

Photo 2

Drill wiring hole designated with "W" to 1/2"

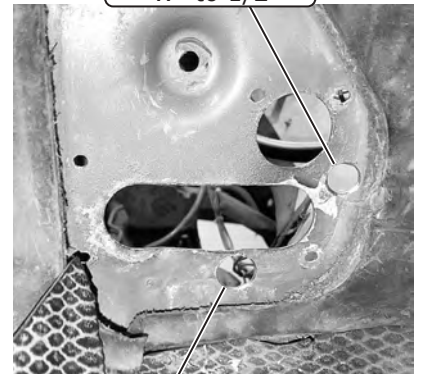

Photo 3

Drill drain hose hole designated with "D" to 5/8"

Between stock holes on firewall, cut out about 3/4" of firewall to ease installation of new hoses



Photo 4

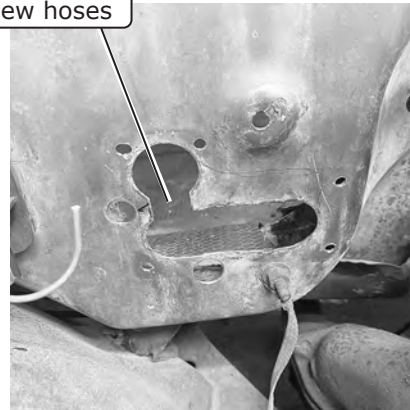

Photo 5



www.vintageair.com

Firewall Modification and Insulation (Cont.)

- Use (4) 1/4-20 x 3/4" hex bolts, (8) 1/4" I.D. x 9/32" O.D. fender washers, and (4) 1/4-20 locknuts to cover the holes that are no longer used (See Photos 6 and 7, below).
- Use either the 1 3/4" or 2" plastic plug to cover the opening that the previous line for the accumulator came through (See Photo 8, below).

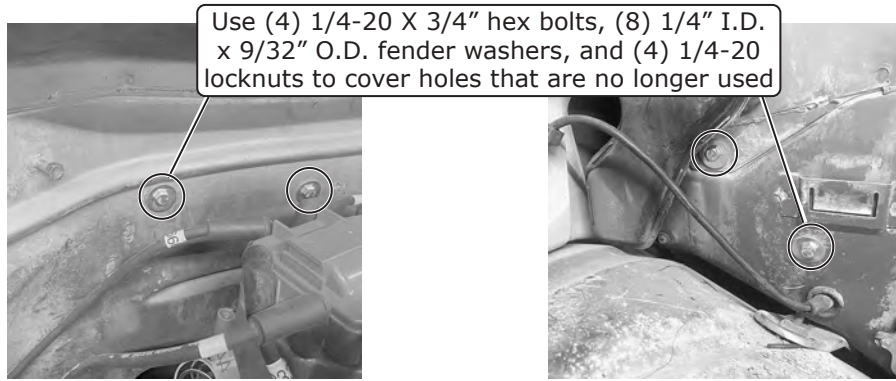

Photo 6

Photo 7

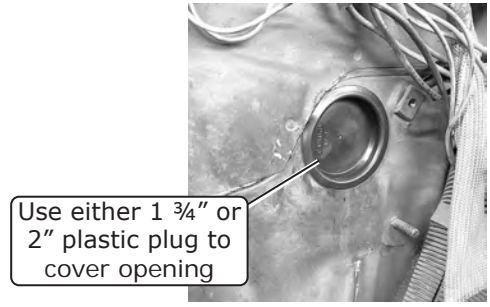
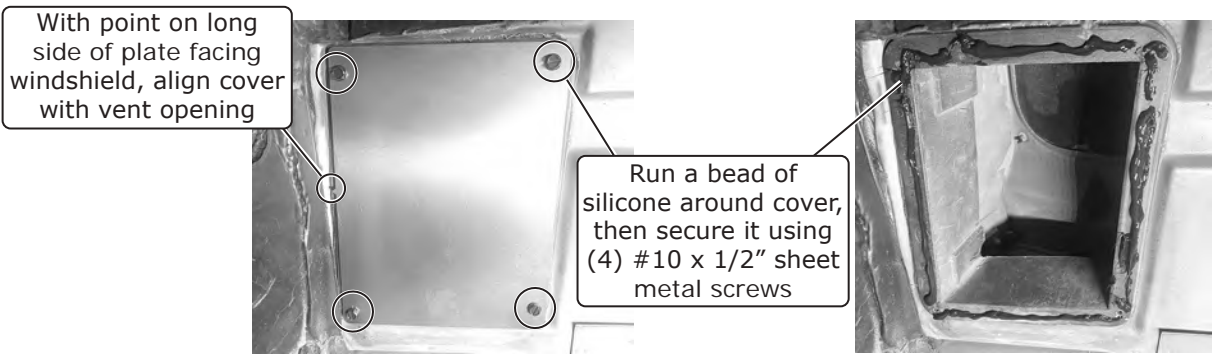

Photo 8

Fresh Air Vent Cover Installation

- With the point on the long side of the plate facing the windshield, align the cover with the vent opening (See Photo 1, below). Mark and drill out the (4) holes with a 9/64" drill bit.
- Run a bead of silicone around the cover, then secure it using (4) #10 x 1/2" sheet metal screws (See Photos 1 and 2, below).



With point on long side of plate facing windshield, align cover with vent opening

Run a bead of silicone around cover, then secure it using (4) #10 x 1/2" sheet metal screws

Photo 1

Photo 2



www.vintageair.com

Evaporator Module Preparation

On a workbench, perform the following:

1. Using (4) spring clips, install the dash plenum onto the front of the module (See Photo 1, below).
2. Using (2) spring clips, install the floor plenum onto the back of the module (See Photo 2, below).
3. Using (2) spring clips, install the defrost plenum onto the front of the module (See Photo 3, below).
4. Install (2) 1/2" plastic plugs into the (2) holes on the module (See Photo 4, below). With properly lubricated #10 O-rings (See Lubricating O-rings, Page 13), install both heater fittings onto the module with the 90° fitting on top and the 135° fitting on the bottom (See Photo 4, below).
5. Using (4) #10 x 5/8" screws, install the evaporator bracket onto the module (See Photo 5, below).
6. Install (2) 1/4-20 x 1 1/2" full-threaded studs into the lower and passenger-side weld nuts on the evaporator bracket (See Photo 6, below).

Using (4) spring clips, install dash plenum onto front of module

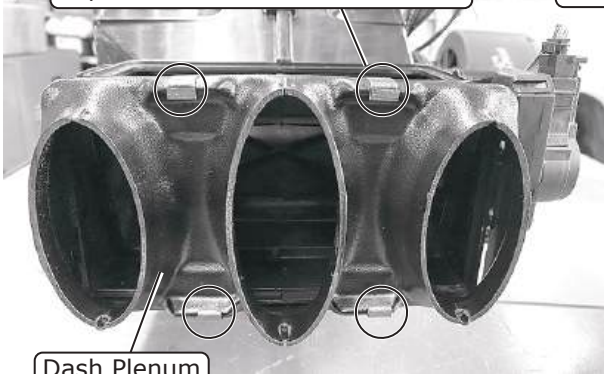

Dash Plenum
629906

Photo 1

Using (2) spring clips, install floor plenum onto back of module

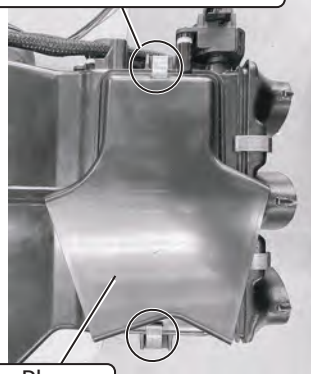

Floor Plenum
625338

Photo 2

Using (2) spring clips, install defrost plenum onto front of module

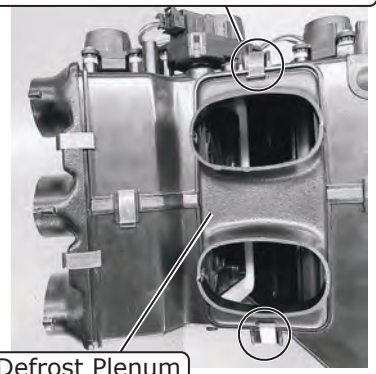

Defrost Plenum
629905

Photo 3

Install 90° heater fitting on top

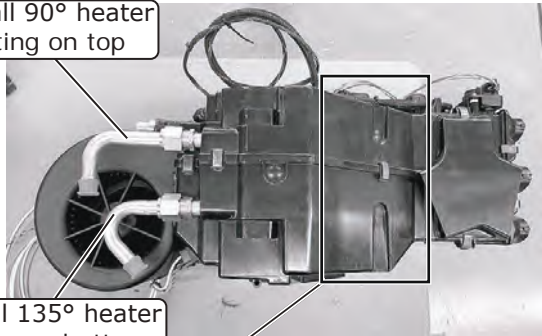

Install 135° heater fitting on bottom



Install (2) 1/2" plastic plugs

Photo 4

Using (4) #10 x 5/8" screws, install evaporator bracket onto module

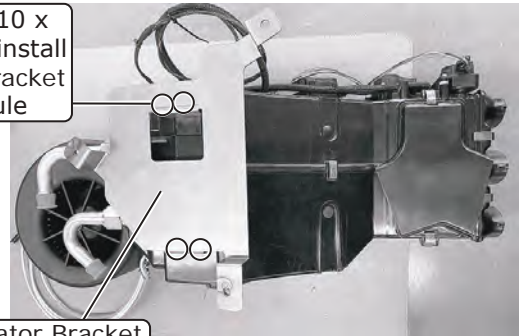

Evaporator Bracket
649690

Photo 5

Install (2) 1/4-20 x 1 1/2" full-threaded studs into lower and passenger-side weld nuts on evaporator bracket

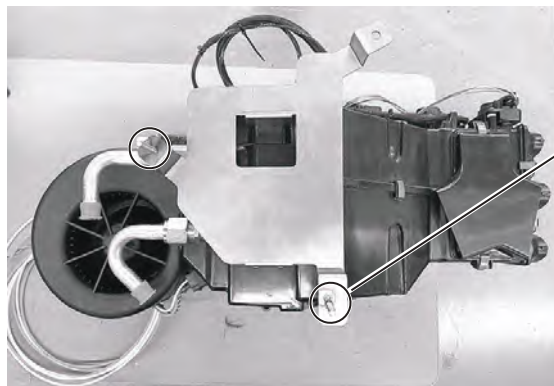
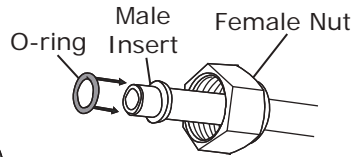
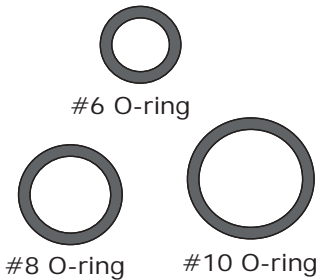

Photo 6



www.vintageair.com

Lubricating O-rings



For a proper seal of fittings: Install supplied O-rings as shown and lubricate with refrigerant oil.

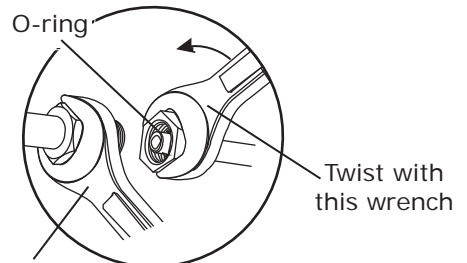
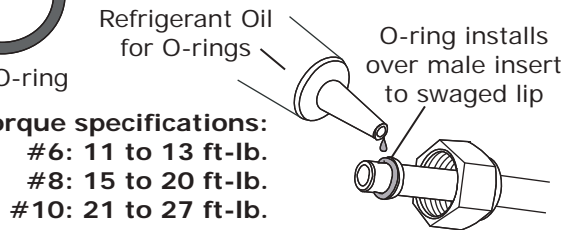

NOTE: Standard torque specifications:
#6: 11 to 13 ft-lb.
#8: 15 to 20 ft-lb.
#10: 21 to 27 ft-lb.

Hold with this wrench

Twist with this wrench

Passenger Compartment A/C Hose Installation

1. Run the 90° fitting of the #10 A/C hose through the firewall cover, the top hole of the rubber boot, then into the passenger compartment. Repeat the steps with the 90° fitting of the #6 hose in the hole underneath the #10 A/C hose (See Photo 1, below).
2. With the evaporator module on the floorboard, install the #6 and #10 A/C hoses onto the expansion valve located on top of the module (See Photo 2, below).
3. Wrap the #10 A/C hose fitting separately with press tape (See Photo 3, below).

Run 90° fitting of #10 A/C hose through firewall cover, top hole of rubber boot, then into passenger compartment. Repeat steps with 90° fitting of #6 hose in hole underneath #10 A/C hose

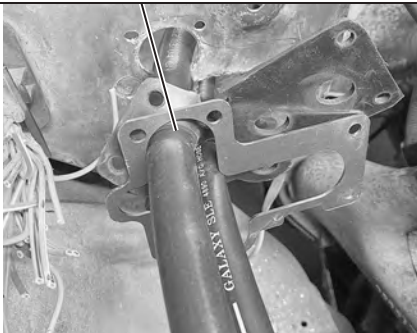
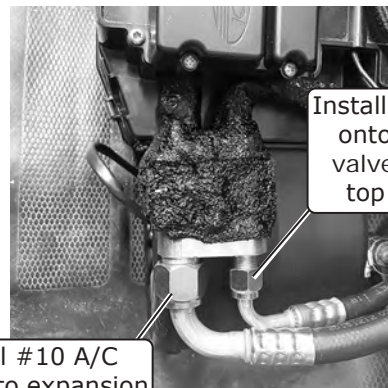

Photo 1



Install #6 A/C hose onto expansion valve located on top of module

Install #10 A/C hose onto expansion valve located on top of module

Photo 2

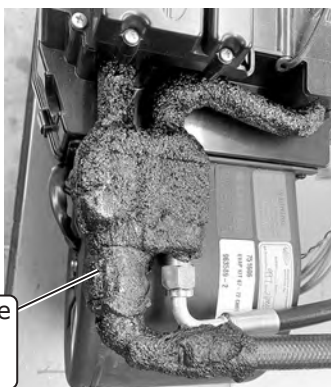

Wrap #10 A/C hose fitting separately with press tape

Photo 3



www.vintageair.com

Heater Hose Installation

NOTE: With the evaporator module on the floorboard, perform the following:

1. Run heater hose through the driver-side opening of the rubber boot on the firewall. Install the heater hose onto the lower heater fitting and secure it with a hose clamp (See Photo 1, below).
2. Run a second hose through the middle hole in the rubber boot on the firewall. Install the heater hose onto the upper heater fitting and secure it with a hose clamp (See Photo 2, below).

Install heater hose on lower heater fitting and secure it with a hose clamp

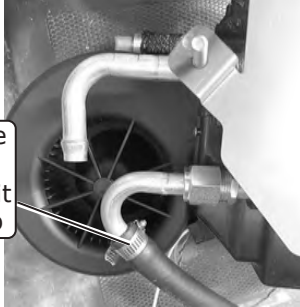

Photo 1

Install heater hose on upper heater fitting and secure it with a hose clamp

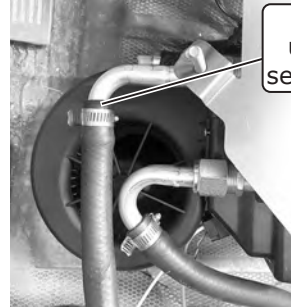

Photo 2

Rubber Boot Installation

1. Align the rubber boot and firewall cover plate with the previously drilled holes on the firewall, then secure both using (5) 10-24 x 3/4" serrated flange bolts (See Photo 1, below).
2. In the passenger compartment, secure the firewall using (5) 10-24 nuts with star washers (See Photo 2, below).

Install rubber boot and firewall cover plate using (5) 10-24 x 3/4" serrated flange bolts

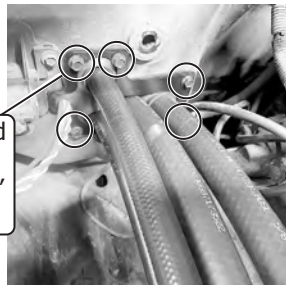
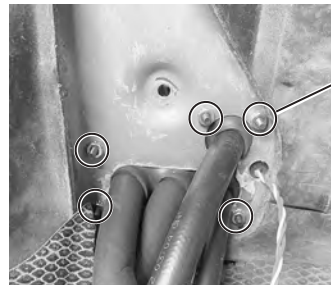

Photo 1

Secure firewall using (5) 10-24 nuts with star washers



Passenger Compartment View

Photo 2

Wiring Installation: Part 1

NOTE: Cut wires to length as necessary. Do not connect the power until the installation is complete.

1. Locate the main wiring harness. Route the heater control valve plug and wiring through the rubber boot and into the engine bay (See Photo 1, below).
2. Route the red, white, and blue wires from the main wiring harness through the rubber boot and into the engine bay (See Photo 2, below).
3. Route the orange and white wires from the main wiring harness through the rubber boot and into the engine bay (See Photo 3, below). Wrap these wires with the flexo sleeve.

Route heater control valve plug and wiring through rubber boot and into engine bay

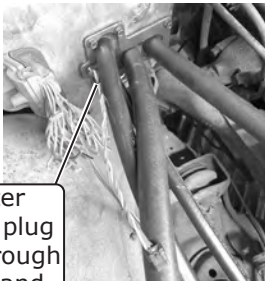

Photo 1

Route red, white and blue wires from main wiring harness through rubber boot and into engine bay

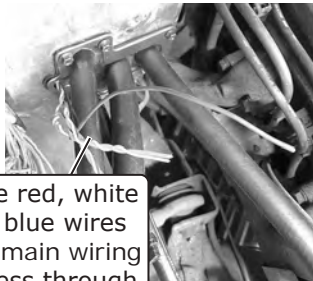

Photo 2

Route orange and white wires from main wiring harness through rubber boot and into engine bay



Photo 3



www.vintageair.com

Evaporator Installation

1. From the passenger compartment, install the evaporator module by pushing the (2) 1/4-20 x 1 1/2" full-threaded studs through the firewall, then on the top driver-side opening, reinstall the hardware.
2. From the engine bay, replace the (2) 1/4-20 x 1 1/2" full-threaded studs with (2) 1/4-20 x 3/4" serrated flange black zinc bolts (See Photo 1, below).
3. In the passenger compartment, ensure the hoses are pushed through all the way, then tie wrap them together (See Photo 2, below).

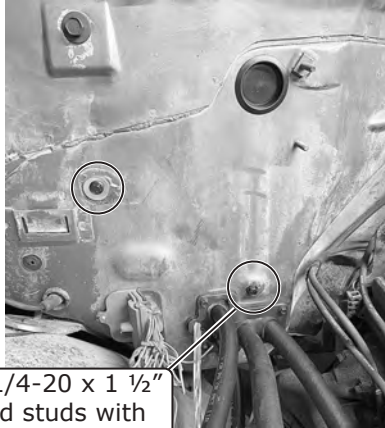

Replace (2) 1/4-20 x 1 1/2" full-threaded studs with (2) 1/4-20 x 3/4" serrated flange black zinc bolts

Photo 1

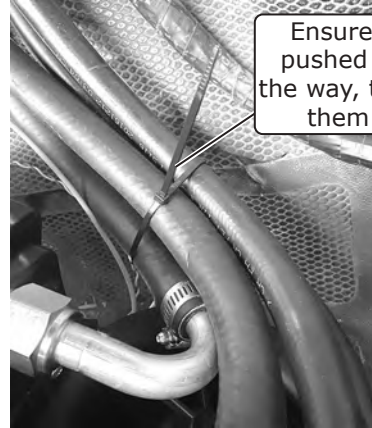

Ensure hoses are pushed through all the way, then tie wrap them together

Photo 2

Evaporator Leveling

1. Remove the evaporator ECU from the top of the evaporator module and set it to the side without unplugging it.
2. Remove the (2) plugs from the front of the evaporator module and replace them with (2) 1/4-20 well nuts (See Photo 1, below).
3. Once the evaporator module is leveled, install the cowl bracket in front of the evaporator module using (2) 1/4-20 x 3/4" serrated flange black zinc bolts (See Photo 2, below).

Remove (2) plugs from front of evaporator module and replace them with (2) 1/4-20 well nuts

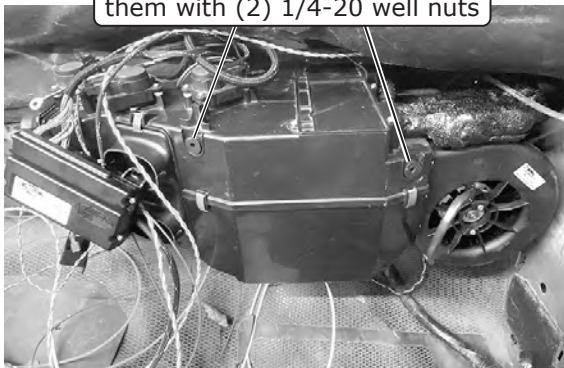
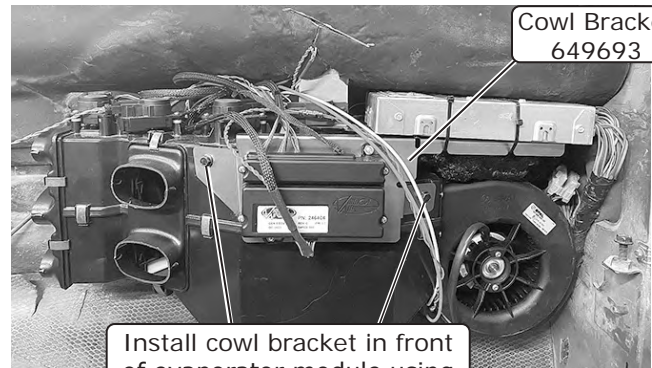

Photo 1



Cowl Bracket
649693

Install cowl bracket in front of evaporator module using (2) 1/4-20 x 3/4" serrated flange black zinc bolts

Photo 2



www.vintageair.com

Evaporator Leveling (Cont.)

4. Mark where the bracket sits against the insulation. Cut a small piece of insulation out to be able to slide the cowl bracket behind it.
5. With the insulation gently pulled down, mark the top holes on the cowl bracket. Drill out (2) 9/64" pilot holes. Secure the cowl bracket with a #10 x 1/2" sheet metal screw (See Photo 3, below).
6. Use (4) tie wraps to secure the stock engine ECU onto the shelf above the blower, then plug it back into the stock harness (See Photo 4, below).
7. Install the engine ECU onto the cowl bracket using (2) 10-24 x 1/2" pan head screws (See Photo 4, below).

Secure cowl bracket with (2) #10 x 1/2" sheet metal screws



Photo 3

Use (4) tie wraps to secure stock engine ECU

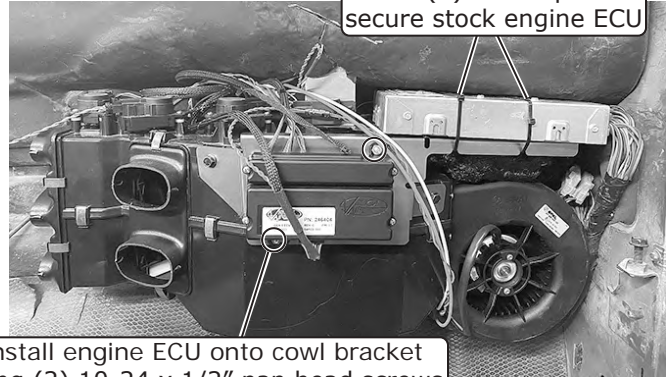

Install engine ECU onto cowl bracket using (2) 10-24 x 1/2" pan head screws

Photo 4

Drain Hose Installation

1. Cut the drain hose at 7 1/2" (See Photo 1, below). From the engine compartment, install the drain hose through the previously drilled hole in the firewall, then connect it to the evaporator module (See Photo 2, below). In the engine compartment, connect the drain hose to the elbow. Next, connect the remainder of the drain hose to the elbow and route it away from the exhaust (See Photo 3, below).

Drain Hose 31050-VUD

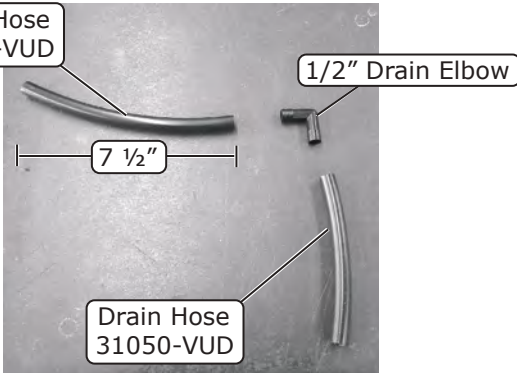
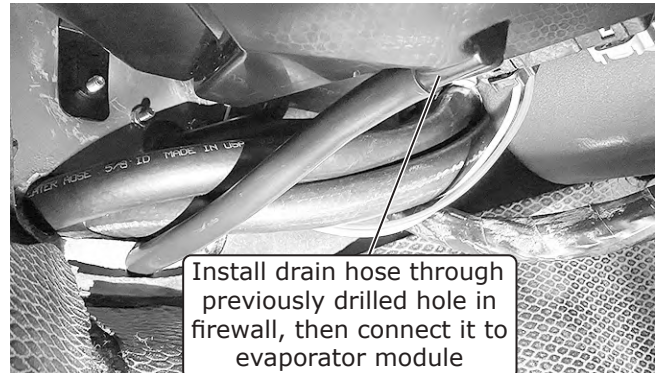

Photo 1



Install drain hose through previously drilled hole in firewall, then connect it to evaporator module

Photo 2

Connect remainder of drain hose to elbow and route it away from exhaust

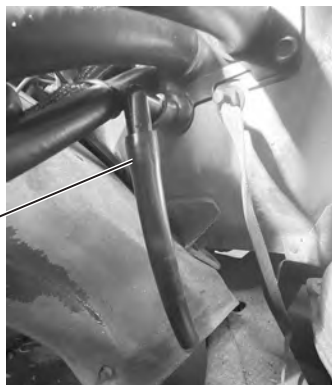

Photo 3



www.vintageair.com

A/C Hose Installation

1. Route the 45° fitting of the #6 A/C hose from the firewall, along the inner fender. With a properly lubricated #6 O-ring (See Lubricating O-rings, Page 13), install the fitting onto the outgoing port of the drier (See Photo 1, below).
2. Route the straight fitting with service port of the #10 A/C hose from the firewall. With a properly lubricated #10 O-ring (See Lubricating O-rings, Page 13), install the fitting onto the suction port on the compressor (See Photo 2, below). **NOTE: Ensure the service port is pointing up.**
3. With a properly lubricated #8 O-ring (See Lubricating O-rings, Page 13), install the straight fitting with service port of the #8 A/C hose onto the discharge port on the compressor (See Photo 3, below). **NOTE: Ensure the service port is pointing up.**
4. Route the straight fitting of the #8 A/C hose to the #8 hardline on the condenser. With a properly lubricated #8 O-ring (See Lubricating O-rings, Page 13), install the fitting (See Photo 4, below).

Install 45° fitting of #6 A/C hose to outgoing port of drier

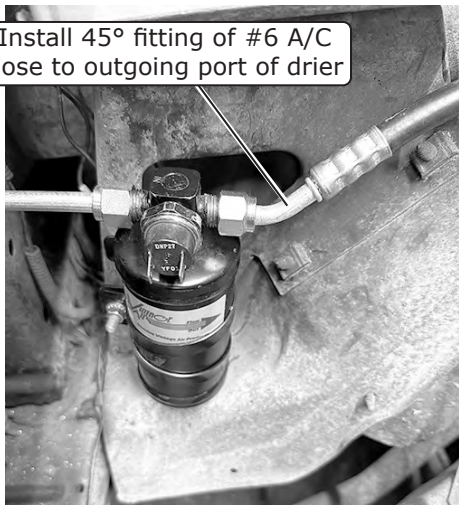

Photo 1

Install straight fitting of #10 A/C hose to suction port on compressor

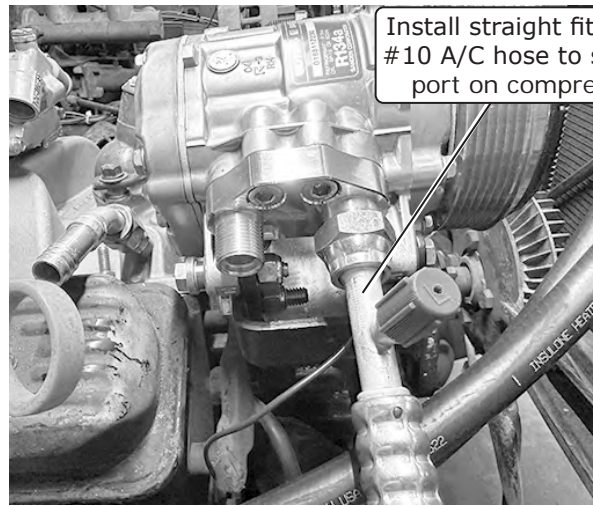

Photo 2

Install straight fitting of #8 A/C hose to discharge port on compressor

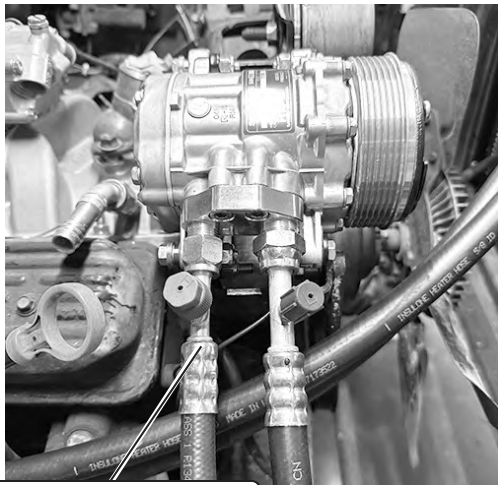

Photo 3

Route straight fitting of #8 A/C hose to #8 hardline on condenser

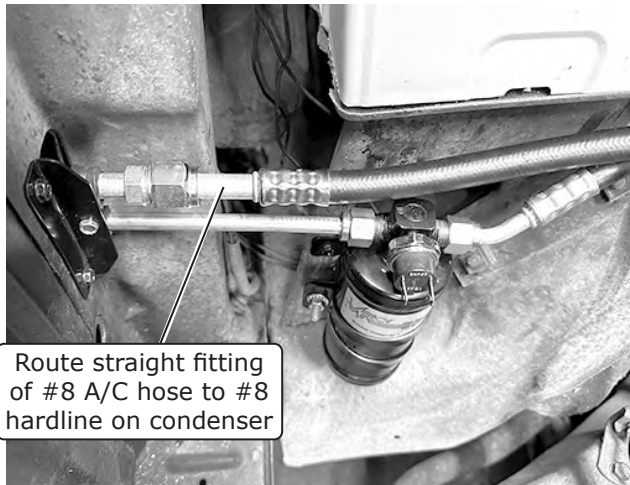

Photo 4



www.vintageair.com

Heater Hose & Heater Control Valve Installation

NOTE: Vintage Air systems use 5/8" heater connections. On engines equipped with 3/4" hose nipples, these will need to be removed and replaced with 5/8" nipples (not supplied). For water pumps with a cast-in 3/4" heater outlet, a 3/4" x 5/8" reducer fitting (not supplied) or molded hose will need to be installed in the heater hose.

1. Connect the heater hose from the passenger side of the firewall cover to the port on the intake and secure with a hose clamp.
2. Cut a 5" section of heater hose about 2" from the firewall. Install the heater control valve and secure it with (2) hose clamps (See Photo 1, below), ensuring the molded arrow is pointing towards the firewall.
NOTE: Ensure proper flow direction through the heater control valve. The flow direction follows the molded arrow on the valve (See Figure 1, below).
3. Route the other heater hose from the firewall to the radiator. Secure it to the radiator using a hose clamp.
4. Use a tie wrap to secure the #6 A/C hose, #10 A/C hose and the heater hose back to the stock overflow hose located on the side of the passenger-side inner fender (See Photo 2, below).

From Heater Control Valve to Heater Core

Heater Hose

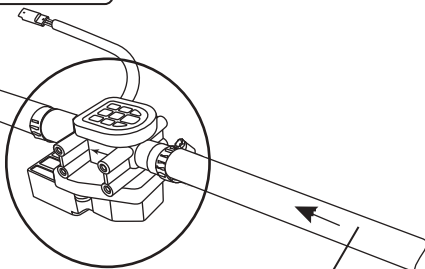

From Intake Manifold

NOTE: Flow Direction Follows Molded Arrow on Valve

Figure 1

Secure heater control valve with (2) hose clamps

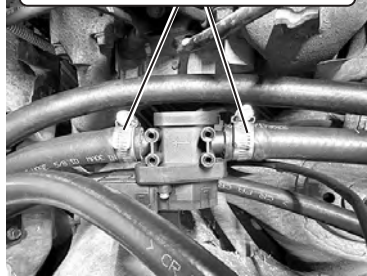

Photo 1

Use a tie wrap to secure #6 A/C hose, #10 A/C hose and heater hose back to stock overflow hose located on side of passenger-side inner fender



Photo 2

Outer Heater Hose Back to Intake

#10 Hose to Compressor

#8 Hose to Compressor

#8 Hose to Condenser

Compressor

#6 Hose to Drier (Under #8 Hose)

Inner Heater Hose Back to Radiator

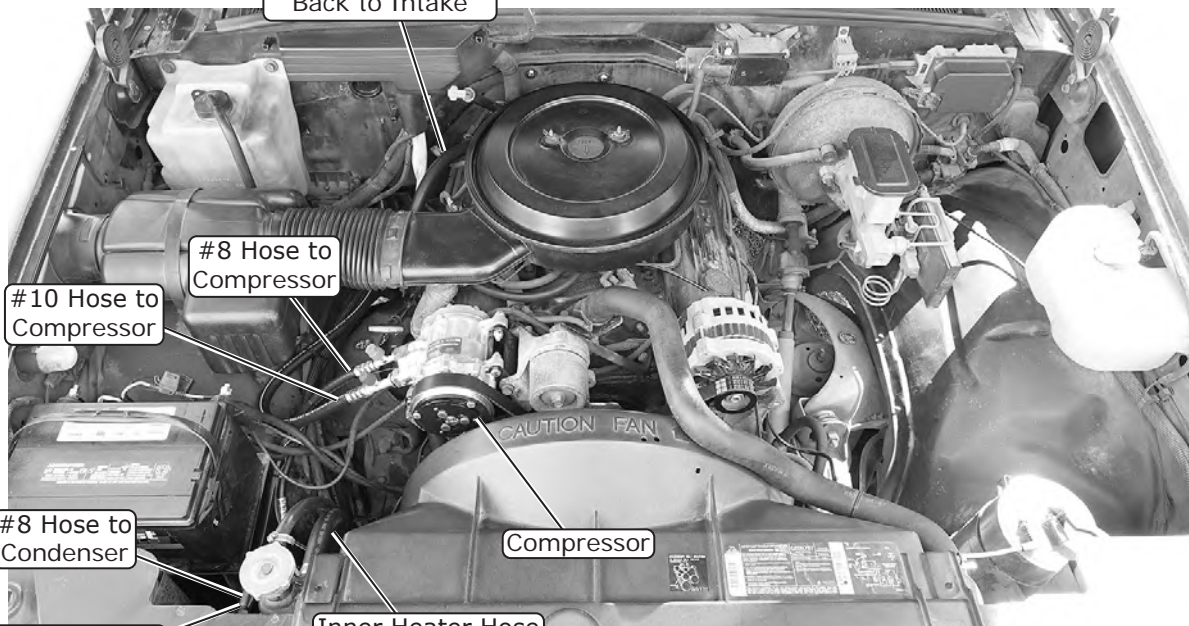

Photo 3



www.vintageair.com

Wiring Installation: Part 2

NOTE: Cut wires to length as necessary. Do not connect the power until the installation is complete.

1. Route the red, white, blue and orange wires along the #6 A/C hose (See Photo 1, below).
2. Reinstall the battery.
3. Connect the blue wires to the binary switch using the supplied spade connector (See Photo 2, below).
4. Install the heat shrink over the 12 AWG orange fuse holder assembly wire and crimp it to the 12 AWG orange wire from the main wiring harness (See Photo 3, below).
5. Install the supplied heat shrink over the 16 AWG black fuse holder assembly and crimp it to the 16 AWG red wire from the main wiring harness (See Photo 3, below).
6. Connect the positive wiring eyelets to the positive battery terminal connector (See Photo 3, below). If necessary, replace the 5/16" diameter ring terminals with the supplied 3/8" diameter ring terminals and heat shrink.
7. Install the supplied heat shrink over the white ground wires, then crimp on the supplied eyelets (See Photo 3, below).
8. Route the compressor lead along the #10 and #6 A/C hoses, then secure it with the supplied tie wraps. Connect the compressor lead to the binary switch using the supplied spade connector (See Photo 4, below).

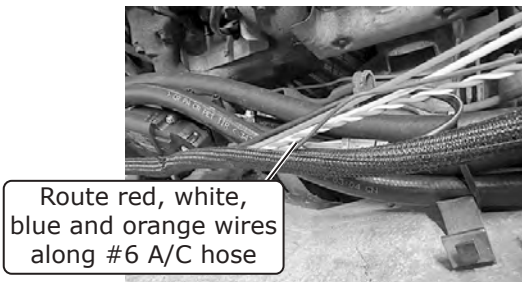

Photo 1

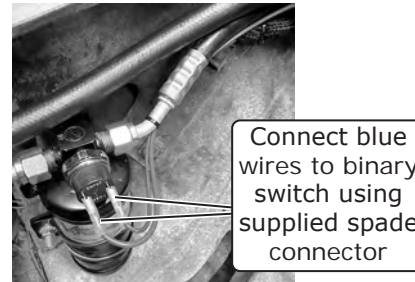

Photo 2

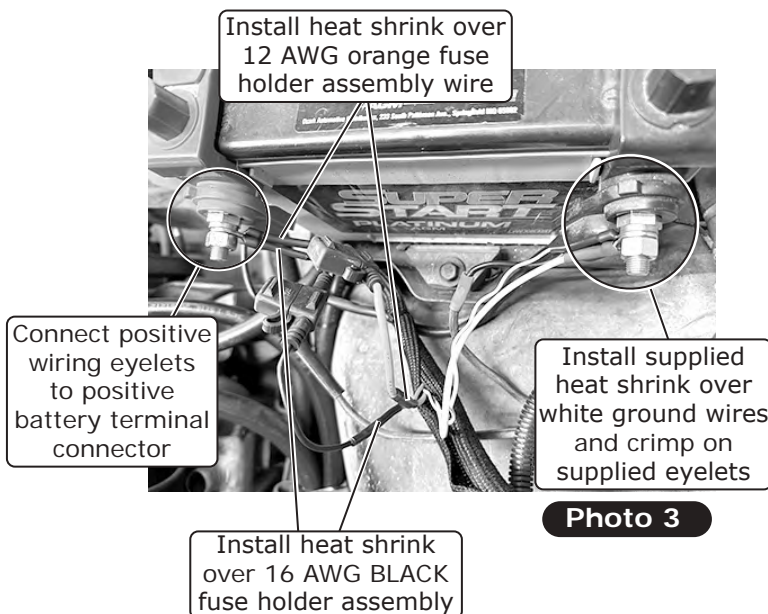

Photo 3

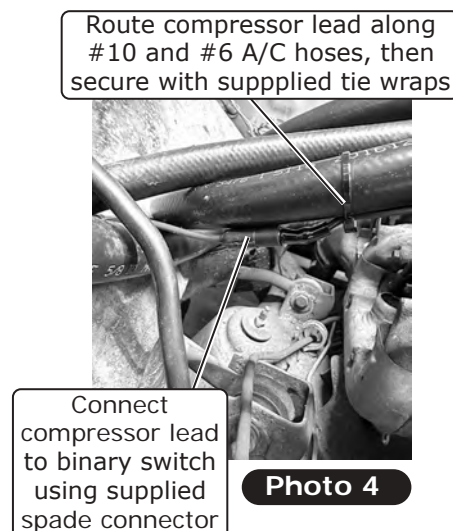

Photo 4



www.vintageair.com

Final Steps: Installation Check

Installation Check	
ITEM TO CHECK	Procedure
<input type="checkbox"/>	<p>ECU</p> <p>If no blinking is observed after 1 minute of turning the ignition on, go to the next check.</p> <p>If repetitive blinking is observed, go to the Advanced Diagnostics Section to diagnose.</p>
<input type="checkbox"/>	<p>Blower speed control</p> <p>Set the blower speed control to OFF, <u>confirm that the blower is off</u>.</p> <p>Position the blower speed control to LOW then MEDIUM and then HIGH. <u>At each setting confirm that the blower speed increases</u>, do this by feeling for the amount of air coming from the unit and hearing the blower speed increase.</p>
<input type="checkbox"/>	<p>Mode control</p> <p>Set the MODE control to the DASH position. <u>Confirm that air is being blown at the dash vents</u>.</p> <p>Set the MODE control to the FLOOR position. <u>Confirm that air is being blown at the floor vents</u>.</p> <p>Set the MODE control to the DEFROST position. <u>Confirm that all air is being blown from the defrost vents</u></p> <p>If heater lines are installed:</p> <p>Set the MODE control to the DASH position. Set the TEMP control to the MAX HEAT position. <u>Confirm that HOT air is coming from the dash vents</u>.</p>
<input type="checkbox"/>	<p>Temperature control</p> <p>If system is charged:</p> <p>Set the TEMP control to the MAX COOL position. <u>Confirm that COLD air is coming from the dash vents</u>.</p> <p>Also <u>confirm that the compressor "clicks" on</u> when adjusting the TEMP control from the MAX HEAT position to the MAX COOL position.</p>
<input type="checkbox"/>	<p>AC Indicator (If applicable)</p> <p>While the MODE control is set to the DASH position, and the TEMP control is set to the MAX COOL/MIN HEAT position, <u>confirm that the blue AC Indicator light is on</u>.</p>
<input type="checkbox"/>	<p>Backlight (If applicable)</p> <p>If your control panel has backlight capabilities and has been wired, turn the dash lamp on and <u>confirm that the AC panel's legend is lit</u>.</p>
<input type="checkbox"/>	<p>Fittings</p> <p>Verify AC and Heater fittings are all tight.</p>



www.vintageair.com

5 Outlet Hose Adapter Installation

1. Install a piece of 3/8" x 1/2" polyurethane open cell foam on the 5 outlet hose adapter as shown in Photo 1, below.
2. Install (6) S-clips onto the 5 outlet hose adapter as shown in Photo 1, below. **NOTE: Install small side of S-clip on outside as shown in Photo 2, below.**
3. Install the 5 outlet hose adapter onto the OEM defrost and OEM dash plenum (See Photo 3, below).

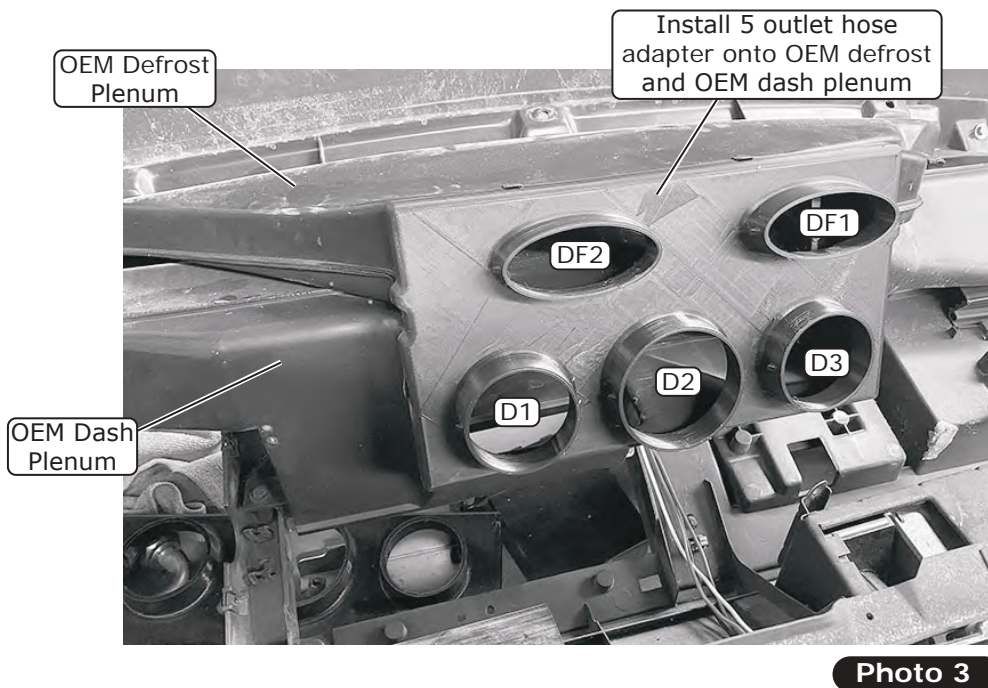
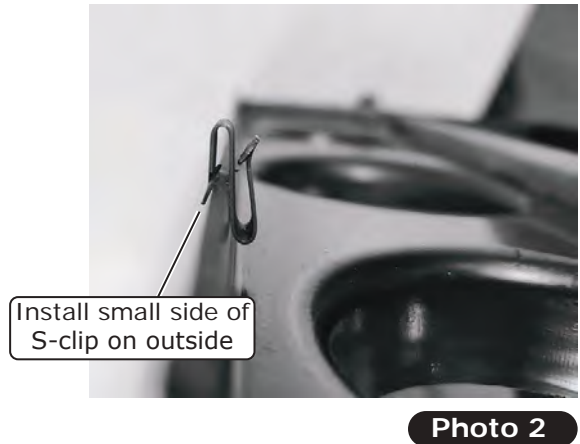
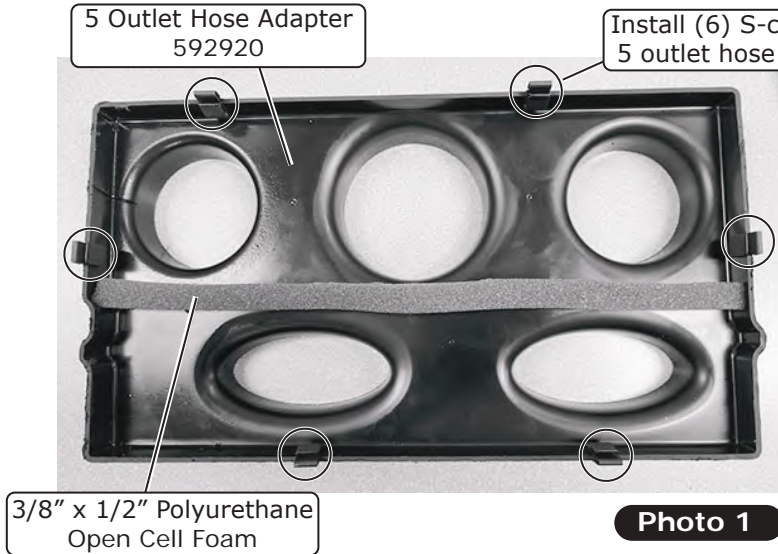

Dash Reinstallation

1. Lower the dash back into place.
2. Reinstall the instrument cluster and radio.
3. Refer to the control panel instructions to install the control panel.
4. Reinstall the rest of the dash trim and pieces with the stock hardware.



www.vintageair.com

Duct Hose Routing

NOTE: Before installing duct hoses, install the control panel. Refer to Control Panel instructions for more information. For the system to function optimally, the duct hoses must be routed as directly as possible, taking care to avoid kinks, sharp bends and unnecessary length. Vintage Air supplies duct hoses in continuous lengths that will need to be cut to size depending on application. Before cutting, familiarize yourself with the installation instructions and verify the routing will work with your application. For custom hose routing, additional hose may be needed and can be purchased from Vintage Air.

1. Stretch the duct hose until there is no slack, measure, mark and cut hose to size (See Photo 1, below).
2. Connect the 2 ½" duct hoses to Defrost 1 (DF1) and Defrost 2 (DF2) on the hose adapter as shown in Figure 1, below. Leave the other ends of the duct hoses disconnected on the driver-side floorboard.
3. Connect the 2 ½" and 3" duct hoses onto Dash 1 (D1), Dash 2 (D2) and Dash 3 (D3) on the hose adapter, then onto the dash plenum as shown in Figure 1 and Photo 2, below.
4. Finally, connect the 2 ½" duct hoses from the hose adapter onto Defrost 1 (DF1) and Defrost 2 (DF2) on the defrost plenum as shown in Figure 1, below.



Photo 1

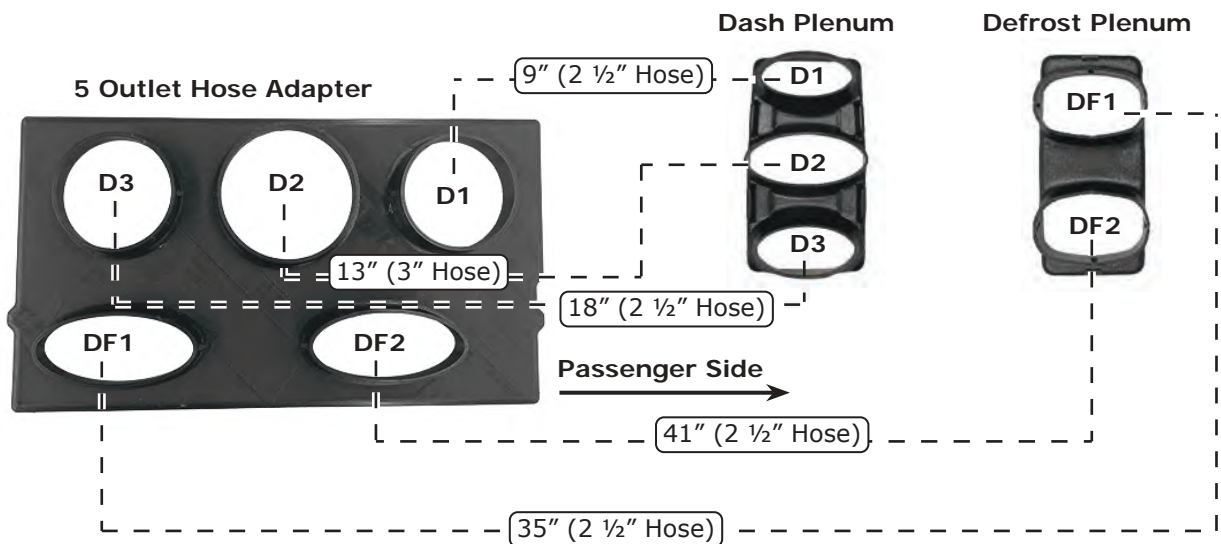

Figure 1

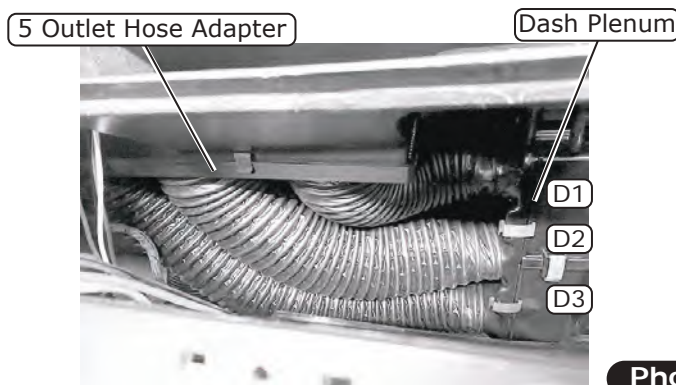

Photo 2



www.vintageair.com

Final Steps: Completing the Install

1. Reinstall all previously removed items.
2. Fill radiator with at least a 50/50 mixture of approved antifreeze and distilled water. It is the owner's responsibility to keep the freeze protection at the proper level for the climate in which the vehicle is operated. Failure to follow antifreeze recommendations will cause heater core to corrode prematurely and possibly burst in A/C mode and/or freezing weather, voiding your warranty.
3. Double check all fittings, brackets and belts for tightness.
4. Vintage Air recommends that all A/C systems be serviced by a licensed automotive A/C technician.
5. Evacuate the system for a minimum of 45 minutes prior to charging, and perform a leak check prior to servicing.
6. Charge the system to the capacities stated on Page 4 of this instruction manual.
7. See Operation of Controls procedures on Page 27.



NOTE: ECU must be placed away from water and humidity, and also be accessible for servicing. If relocating, connectors must be positioned towards the bottom.

Position connectors towards bottom



www.vintageair.com

Quality Crimp Guideline

Acceptable strip length
(Some copper visible)

Crimped area is centered
on each side of splice

Bad strip length
(Too much copper visible)
Visible copper should be
just enough to ensure
clearance between splice
area and wire insulation

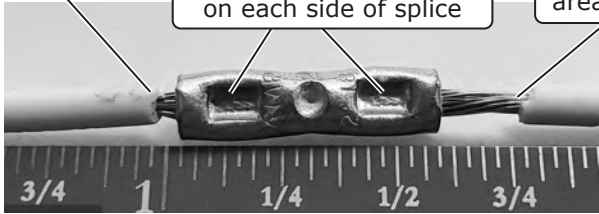

Photo 1

A good crimp requires
seam of butt splice to be
opposite of crimp die tooth



Photo 2

Good Ring Terminal Crimp Bad Ring Terminal Crimp



Crimped
area is
opposite
of seam

Photo 3

Crimp
area is
centered
on barrel

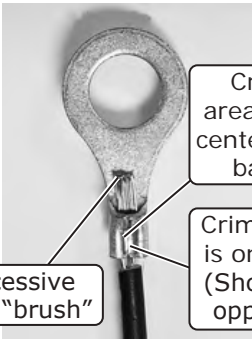

Crimp
area is not
centered on
barrel

Excessive
wire "brush"

Crimp
area
is on seam
(Should be
opposite)

Photo 4



Photo 5

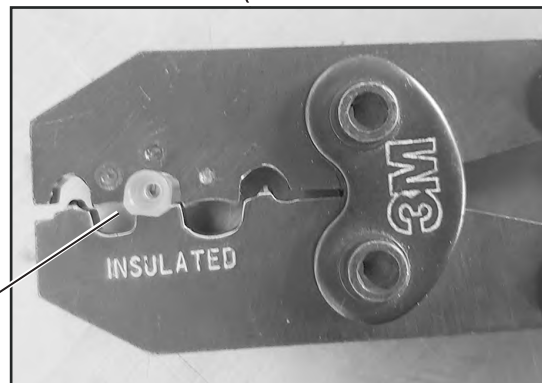

Photo 5a

Use a ratcheting crimp tool
for insulated barrel terminals
when crimping the provided
female insulated terminal.
Ensure terminal is inserted in
appropriate position before
crimping.



www.vintageair.com

Gen 5 Wiring Diagram

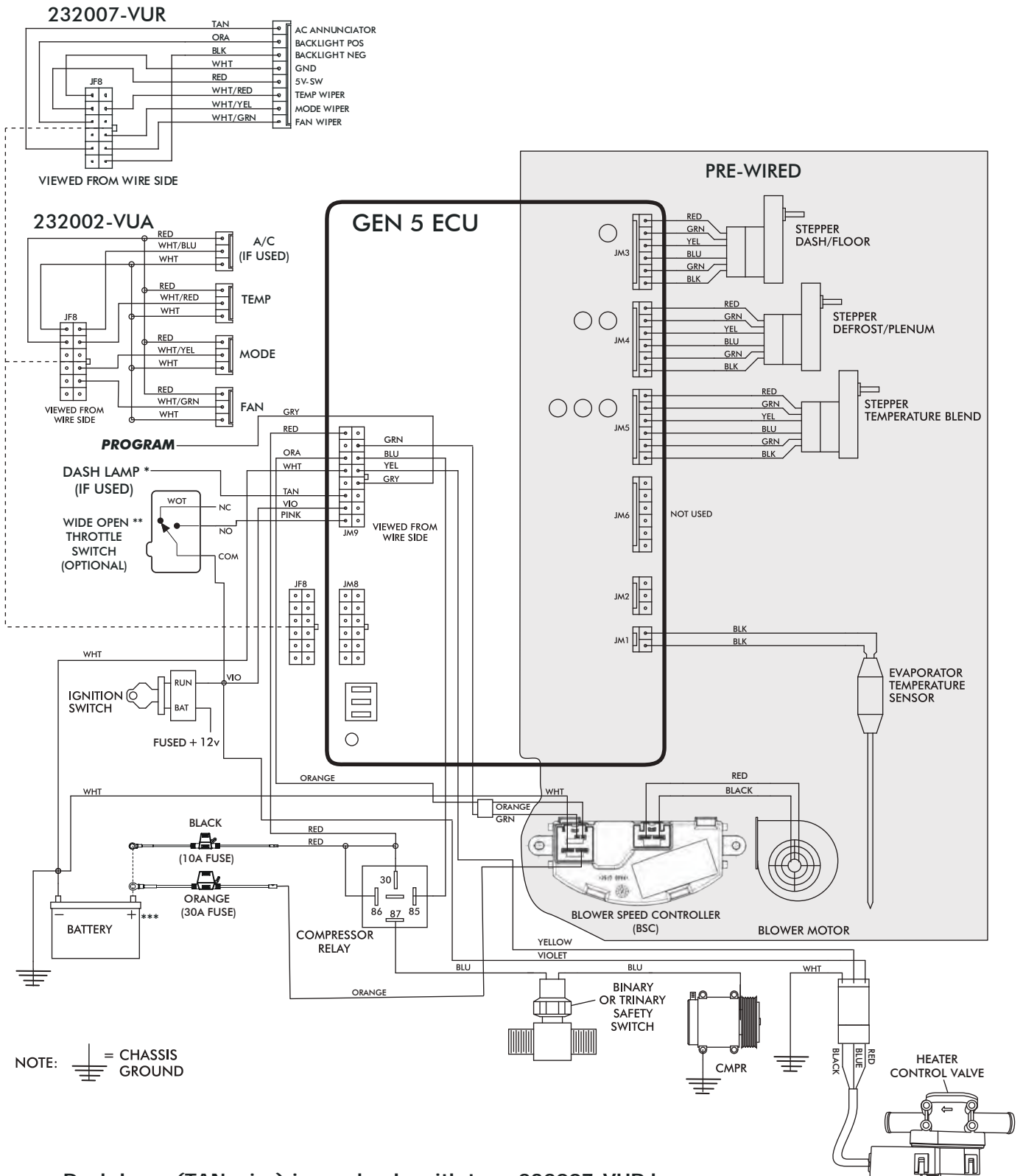

NOTE: = CHASSIS GROUND

- * Dash lamp (TAN wire) is used only with type 232007-VUR harness.
- ** Wide open throttle switch contacts close only at full throttle, which disables A/C compressor.
- *** Install fuse assemblies at or as near to the battery as possible.



www.vintageair.com

Gen 5 Wiring Instructions

WIRING HARNESS (231505) ↓

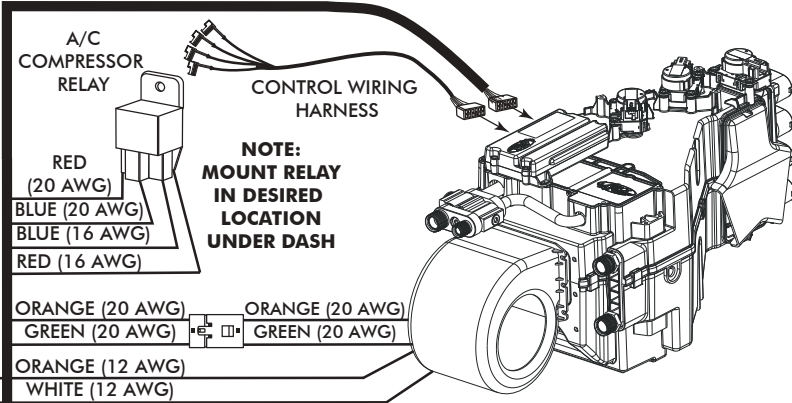

Ignition Switch:
Using provided butt splice (PN 226004), connect the 20 AWG violet wire to a 5A fused and switched 12V source such as Key On.

Wide Open Throttle Switch (Optional):
If a wide open throttle switch is required, connect the 20 AWG pink wire to a normally open switch that, when closed, connects a fused and switched 12V source to the pink wire. See Gen 5 wiring diagram for an example.

Dash Light (Optional):
If using a Vintage Air control panel with back light, connect the 20 AWG tan wire to the vehicle's dash back light 0-12V using provided butt splice (PN 226004).

WIRING HARNESS (232020) →

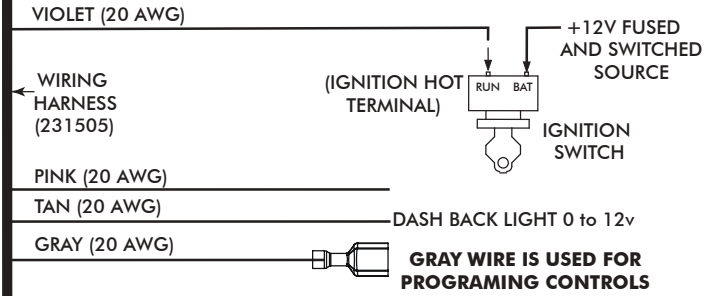

FIREWALL FIREWALL

WIRING HARNESS (232020) →

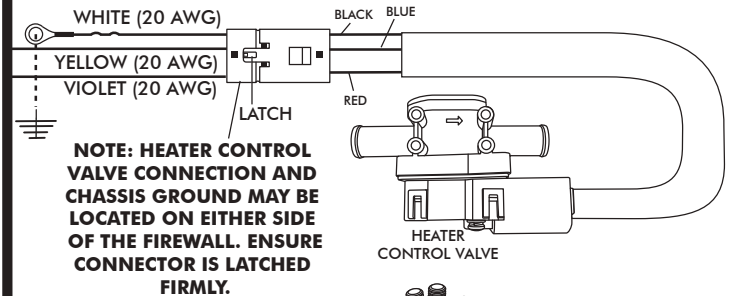

Heater Control Valve:
Connect the Violet/Yellow/White twisted branch with 3 position connector into the heater control valve connector. Ensure that the mating latch is fully seated.

Binary/Trinary & Compressor:
Binary Switch: Terminate provided insulated female terminal (PN 23172-VUW) to the blue 16 AWG wire. Connect as shown.
Trinary Switch: Connect according to trinary switch wiring diagram.

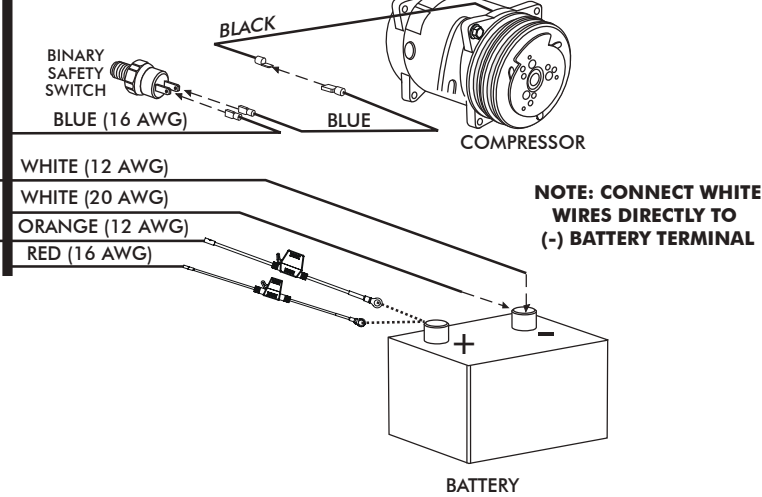

Battery Connections:
ECU Ground: Terminate provided ring terminal (PN 226110) to 20 AWG white wire from the 231505 wire assembly and install at battery.
ECU PWR: Terminate provided fuse assembly with black leads (PN 233012) to the 16 AWG red wire from the 231505 wire assembly. Install provided 10A Red Mini Fuse (PN 226118). Install at battery.
Blower Speed Controller (BSC) Ground: Terminate provided ring terminal (PN 226111) to 12 AWG white wire from the 232020 wire assembly and install at battery.
Blower Speed Controller (BSC) PWR: Terminate provided fuse assembly with orange leads (PN 233008) to the 12 AWG orange wire from the 232020 wire assembly. Install provided 30A Green ATO/ATC Fuse (PN 226125). Install at battery.



www.vintageair.com

Operation of Controls

On Gen IV or Gen 5 systems with three lever/knob controls, the temperature control toggles between heat and A/C operations. To activate A/C, move the temperature lever/knob all the way to cold and then back it off to the desired vent temperature. For heat operation, move the temperature lever/knob all the way to hot and then adjust to the desired vent temperature. The blower will momentarily change speed, each time you toggle in and out of heat and A/C operations, to indicate the change.

Blower Speed

This lever/knob controls blower speed, from OFF to HI.

Mode Control

This lever/knob controls the mode positions, from DASH to FLOOR to DEFROST, with a blend in between.

Temperature Control

This lever/knob controls the temperature, from HOT to COLD.

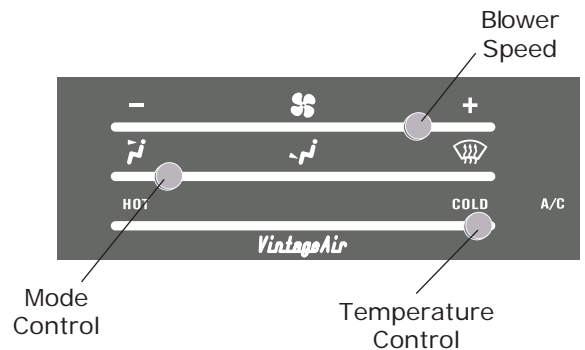

A/C Operation

Blower Speed

Adjust to desired speed.

Mode Control

Adjust to desired mode position (DASH position recommended).

Temperature Control

For A/C operation, adjust to coldest position to engage compressor (adjust between HOT and COLD to reach desired temperature).



Heat Operation

Blower Speed

Adjust to desired speed.

Mode Control

Adjust to desired mode position (FLOOR position recommended).

Temperature Control

For maximum heating, adjust to hottest position (adjust between HOT and COLD to reach desired temperature).

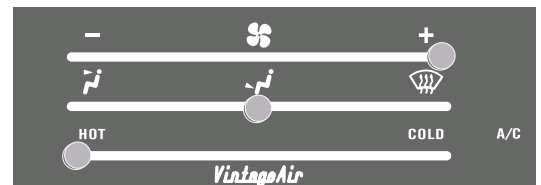

Defrost/De-fog Operation

Blower Speed

Adjust to desired speed.

Temperature Control

Adjust to desired temperature.

Mode Control

Adjust to DEFROST position for maximum defrost, or between FLOOR and DEFROST positions for a bi-level blend (Compressor is automatically engaged).

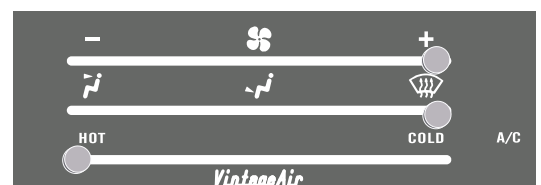



www.vintageair.com

Troubleshooting Guide

This printed troubleshooting guide is our basic guide that covers common installation problems. To see our advanced diagnostics and troubleshooting guide, please refer to the following page for instructions on how to download the complete guide.

WARNING: While troubleshooting the system, never probe connector terminals from the front mating side, only back probe.

WARNING: While troubleshooting the system, never use automotive check lights.

Symptom	Condition	Checks	Actions	Notes
1. Blower stays on high speed with ignition on.	No other functions work.	Check for damaged pins or wires in the control panel wire assembly and mating header at ECU.	If found damaged, replace wire assembly or ECU.	If fuse continues to blow, there is a serious problem in the wiring. Check all wiring and ensure the wire is not damaged and shorting out along its route.
	All other functions work.	Check for a bad ECU GND. Check for damaged pins or wires in the control panel wire assembly and mating header at ECU. Check if Blower power fuse is blown. Check for a bad ECU GND.	If found damaged, replace wire assembly or ECU. Replace fuse. Repair connection.	
2. Compressor will not turn on (All other functions work).	System is not charged.	System must be charged for compressor to engage.	Charge system.	Danger: Never bypass safety switch with engine running. Serious injury can result.
	System is charged.	Check for faulty A/C potentiometer or associated wiring (not applicable to 3-pot controls). Check for disconnected or faulty thermistor.	Check continuity to ground on white control head wire. Check for 5V on red control head wire. Check 2-pin connector at ECU housing.	To check for proper pot function, check voltage at white/red wire. Voltage should be between 0V and 5V, and will vary with pot lever position. Disconnected or faulty thermistor will cause compressor to be disabled.
	Compressor will not turn off (All other functions work).	Check for faulty A/C potentiometer or associated wiring.	Repair or replace pot/control wiring.	Red wire at A/C pot should have approximately 5V with ignition on. White wire will have continuity to chassis ground. White/Red wire should vary between 0V and 5V when lever is moved up or down.
3. Compressor will not turn off (All other functions work).	System is charged.	Check for faulty A/C relay.	Replace relay.	



www.vintageair.com

Troubleshooting Guide (Cont.)

Symptom	Condition	Checks	Actions	Notes
4. System will not turn on, or runs intermittently.	Works when engine is not running; shuts off when engine is started	Noise interference from either ignition or alternator.	Install capacitors on ignition coil and alternator. Ensure good ground at all points. Relocate coil and associated wiring away from ECU and ECU wiring. Check for burned or loose plug wires.	Ignition noise (radiated or conducted) will cause the system to shut down due to high voltage spikes. If this is suspected, check with a quality oscilloscope. Spikes greater than 16V will shut down the ECU. Install a radio capacitor at the positive post of the ignition coil (see radio capacitor installation bulletin). A faulty alternator or worn out battery can also result in this condition.
	Will not turn on under any conditions.	Verify connections on power lead, ignition lead, and both white ground wires. Verify battery voltage is greater than 10 volts and less than 16 while engine is running.	Check for power at ECU, and confirm ignition is being applied to ECU properly. Verify proper meter function by checking the condition of a known good battery.	
5. Loss of mode door function.	No mode change at all.	Check for damaged mode switch or potentiometer and associated wiring.		
	Blower turns on and off rapidly.	Battery voltage is at least 12V. Battery voltage is less than 12V.	Ensure all system grounds and power connections are clean and tight. Charge battery.	System shuts off blower at 10V. Poor connections or weak battery can cause shutdown at up to 11V.
7. Erratic functions of blower, mode, temp, etc.		Check for damaged switch or pot and associated wiring.	Repair or replace.	

Advanced Diagnostics and Troubleshooting Guide

If after referencing the Troubleshooting Guide, the issue is not resolved, move to The Advanced Diagnostics and Troubleshooting Guide that covers the following:

- ECU Diagnostics Codes
- 1. **ECU Blink Sequence**
- 2. **Firmware Version Number**
- 3. **ECU Model Number**
- 4. **ECU Start-Up Blink Sequence**
- 5. Diagnostic Codes
- Complete Advanced Troubleshooting Guidelines

Access the latest version of the Advanced Diagnostics and Troubleshooting Guide by scanning the following QR code on your mobile device:



You can also access the guide by typing the following address into your web browser:

https://www.vintageair.com/instructions_pdf/905000.pdf



www.vintageair.com

Packing List: Evaporator Kit (755737)

No.	Qty.	Part No.	Description
1.	1	765200	Gen 5 Super Magnum Module
2.	1	795737	Accessory Kit

Checked By: _____
Packed By: _____
Date: _____

1



Gen 5 Super
Magnum Module
765200

2

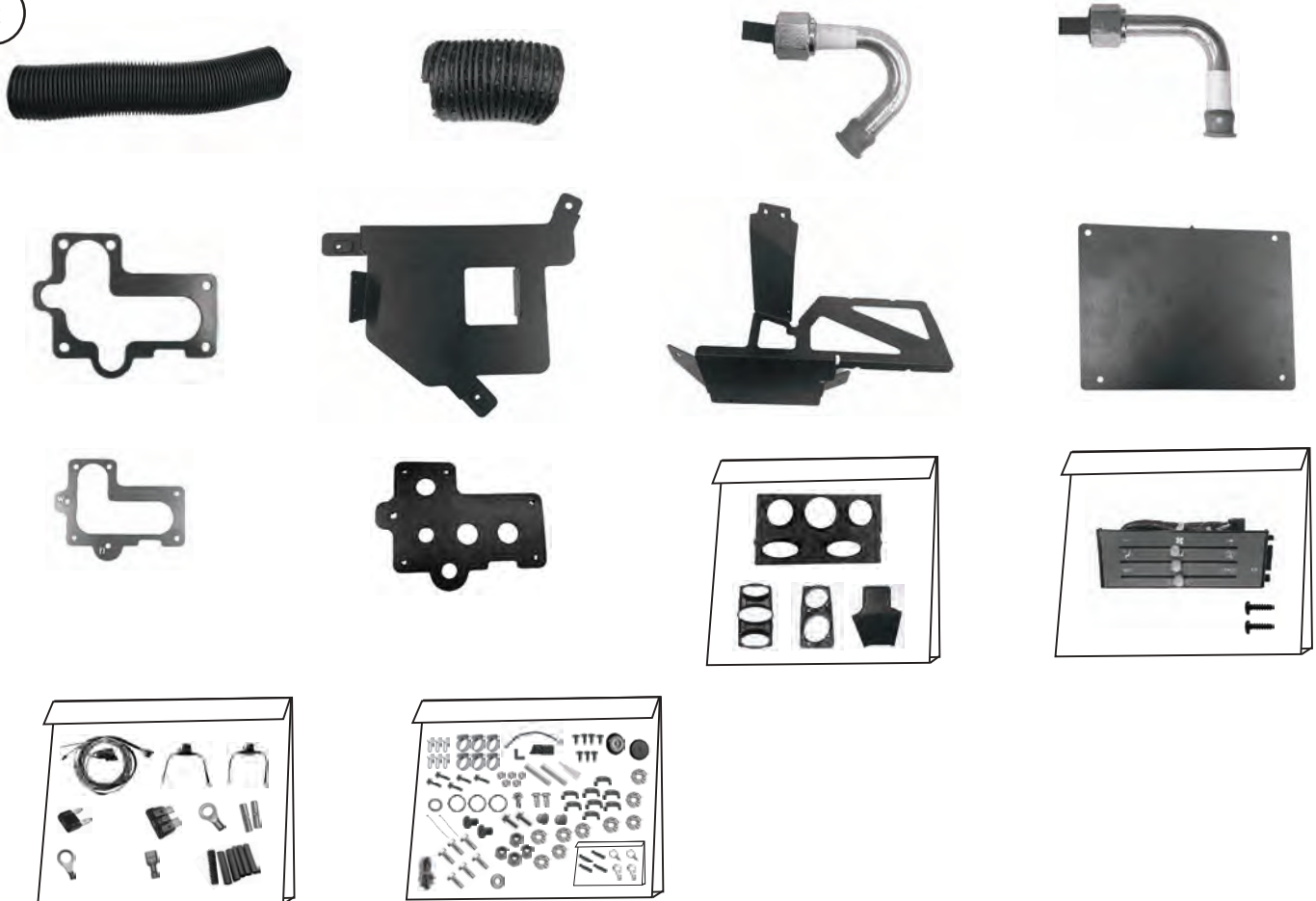

Accessory Kit
795737

**NOTE: Images may not depict actual parts and quantities.
Refer to packing list for actual parts and quantities.**